



Comair Rotron Specification Sheet

Specification Date: April 19, 2017

RoHS Compliant

Version: 00

COMAIR ROTRON PART NUMBER: 17000660A
COMAIR ROTRON MODEL NUMBER: CR2258-4000E2B

A.) MOTOR:

RATED VOLTAGE:	230 VAC
START VOLTAGE:	173 VAC
OPERATING VOLTAGE RANGE:	207~253 VAC
OPERATING FREQUENCY:	50/60 Hz
MAX. RUNNING CURRENT:	0.72 Amps
INPUT POWER:	110 Watts
NOMINAL SPEED:	4000 RPM \pm 10% (At Free Delivery)
MOTOR TYPE:	Brushless EC
MOTOR PROTECTION:	By Integrated Circuit
LOCKED ROTORT PROTECTION:	IC protected
POLARITY PROTECTION:	Yes
AUTOMATIC RESTART CAPABILITY:	By Integrated Circuit
ROTATION:	Clockwise when viewed from the impeller

B.) MECHANICAL

DIMENSIONS:	225x225x80 mm <i>Figure 1</i>
WEIGHT:	1.83 Kg
BEARING TYPE:	Permanently Lubricated Ball Bearings
VENTURI:	High quality magnesium alloy die-casting frame with ED coating& powder coating.
PROPELLER:	High quality magnesium alloy die-casting frame with ED coating& powder coating.



Comair Rotron Specification Sheet

Specification Date: April 19, 2017

RoHS Compliant

Version: 00

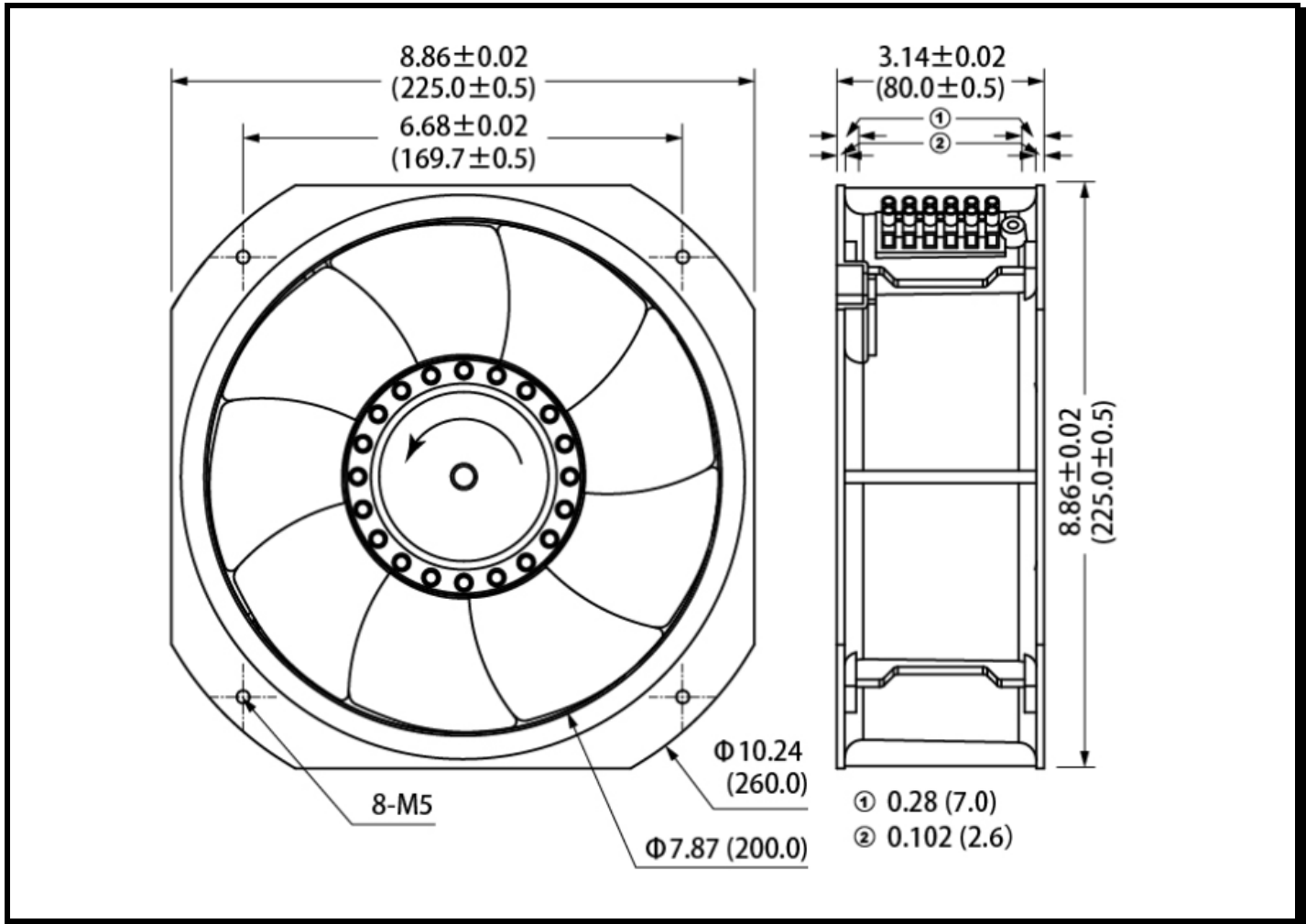

Figure 1

C.) ENVIRONMENTAL

OPERATING TEMPERATURE:

-20°C to +70°C

STORAGE TEMPERATURE:

The storage temperature will be suggested at -20°C ~ 50°C to ensure a better performance.

HUMIDITY:

20 to 85% RH, non-condensing

D.) PERFORMANCE CHARACTERISTICS

AIR FLOW:

838 CFM \pm 5%, Curve D
(At Free Delivery and MAX. speed)



Comair Rotron Specification Sheet

Specification Date: April 19, 2017

RoHS Compliant

Version: 00

STATIC PRESSURE:

1.58" Inches of H₂O, Curve D
(At Shut-Off and MAX. speed)

ACOUSTIC LEVEL:

74 dBA Max. at MAX. speed
(Measured via Freely Suspended at 1 meter)

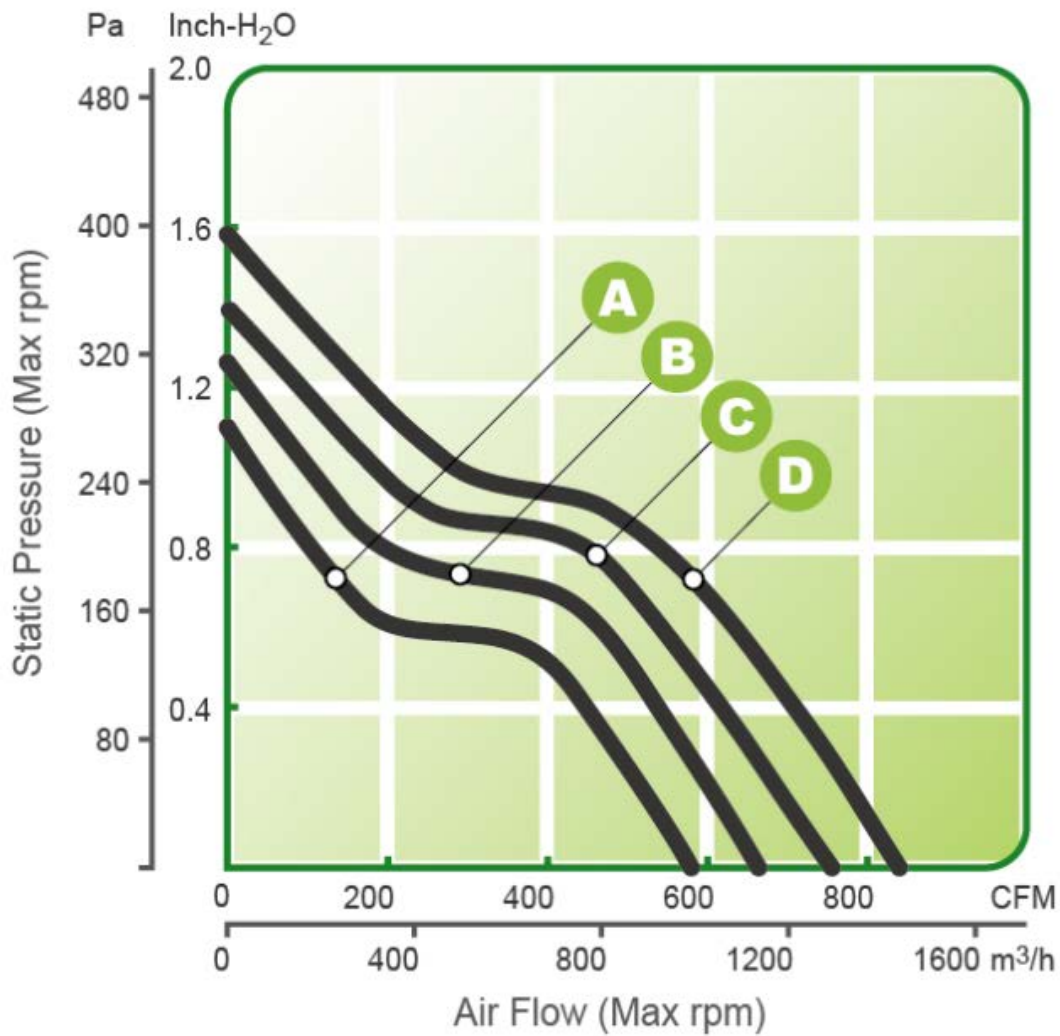



Comair Rotron Specification Sheet

Specification Date: April 19, 2017

RoHS Compliant

Version: 00

E.) TERMINATION

Suit with terminal block, PV1.25-3A-0.5 terminal

F.) RELIABILITY

Bearing type	Temperature	Hours
Ball bearing	20°C	60,000
	40°C	50,000
	60°C	40,000
	90°C	20,000

G.) SAFETY

UL, CUL, TUV, CE