

SPECIFICATIONS

"Preliminary data"



Model Number: CR0512UB-G70(T)
Part Number: 17000190A

Version:
Apr 11, 2017

Mechanical Drawing:

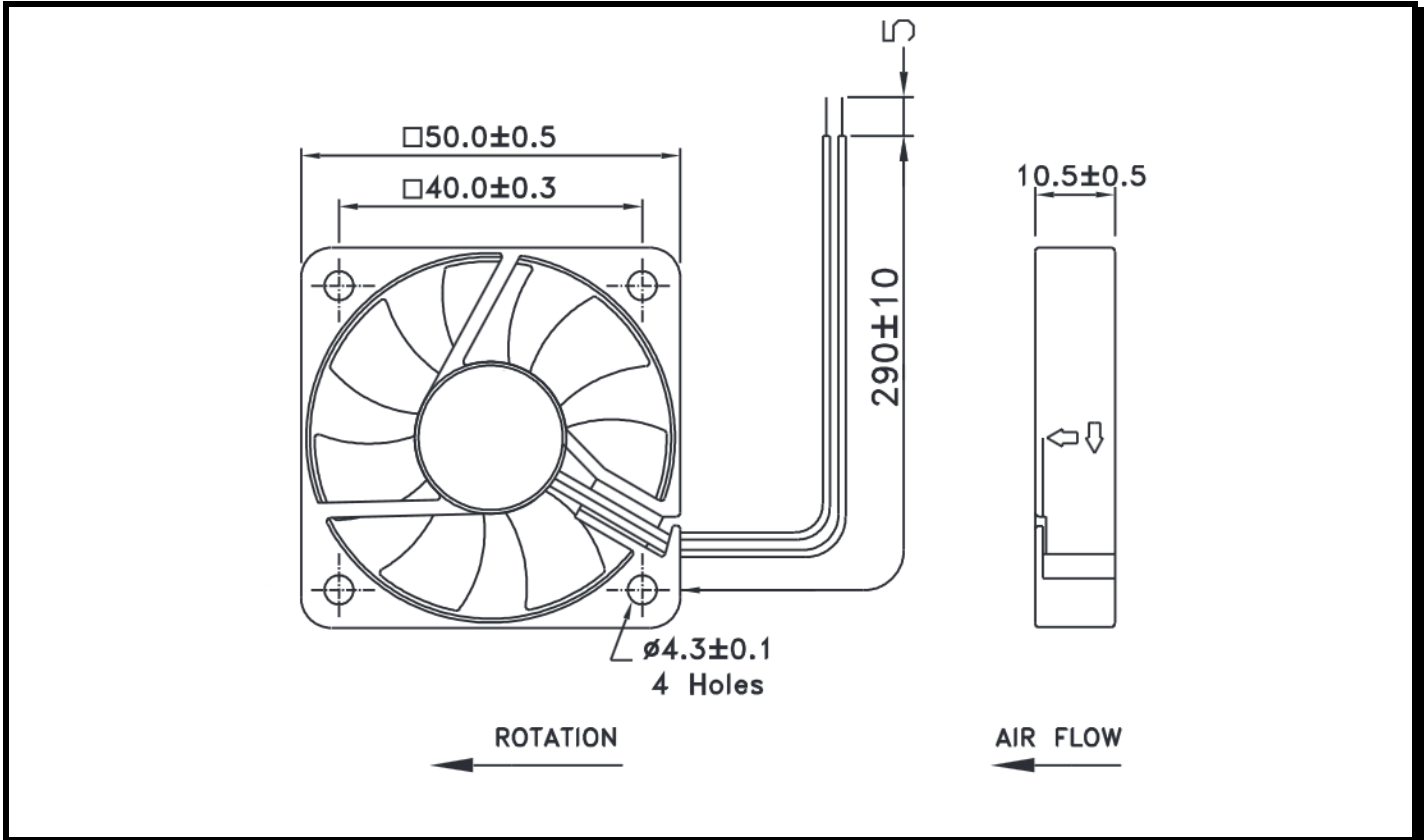

Motor:

Nominal Voltage	= 12 VDC
Nominal Running Current	= 0.10 Amps
Power Input	= 1.20 Watts
Speed	= 5600 RPM
Bearings	= Ball
Air Flow	= 12.0 CFM
Static Pressure:	= 0.12 Inch of H ₂ O
Acoustic	= 32.0 dB(A)
Weight	= 18.0 g

Construction:

Housing: UL94V-0 Glass Filled Polyester (P.B.T)
Impeller: UL94V-0 Glass Filled Polyester (P.B.T)

Life Expectancy:

This fan is designed for continuous duty life of 70,000 hours at 40°C.

Additional Features:

Brushless DC Motor
Locked Rotor Protection
Polarity Protected
Automatic Restart Capability
Operating Temperature: -10° C to 70° C
Storage Temperature: -40° C to 70° C

Termination:

290 ± 10 mm Lead wires, AWG 26, UL 1007

Agency Approvals:

UL, CUL, TUV, CE