

SPECIFICATIONS

"Preliminary data"

Model Number: CR0824LB-D90(T)
Part Number: 17000187A

Version:
Apr 11, 2017



Mechanical Drawing:

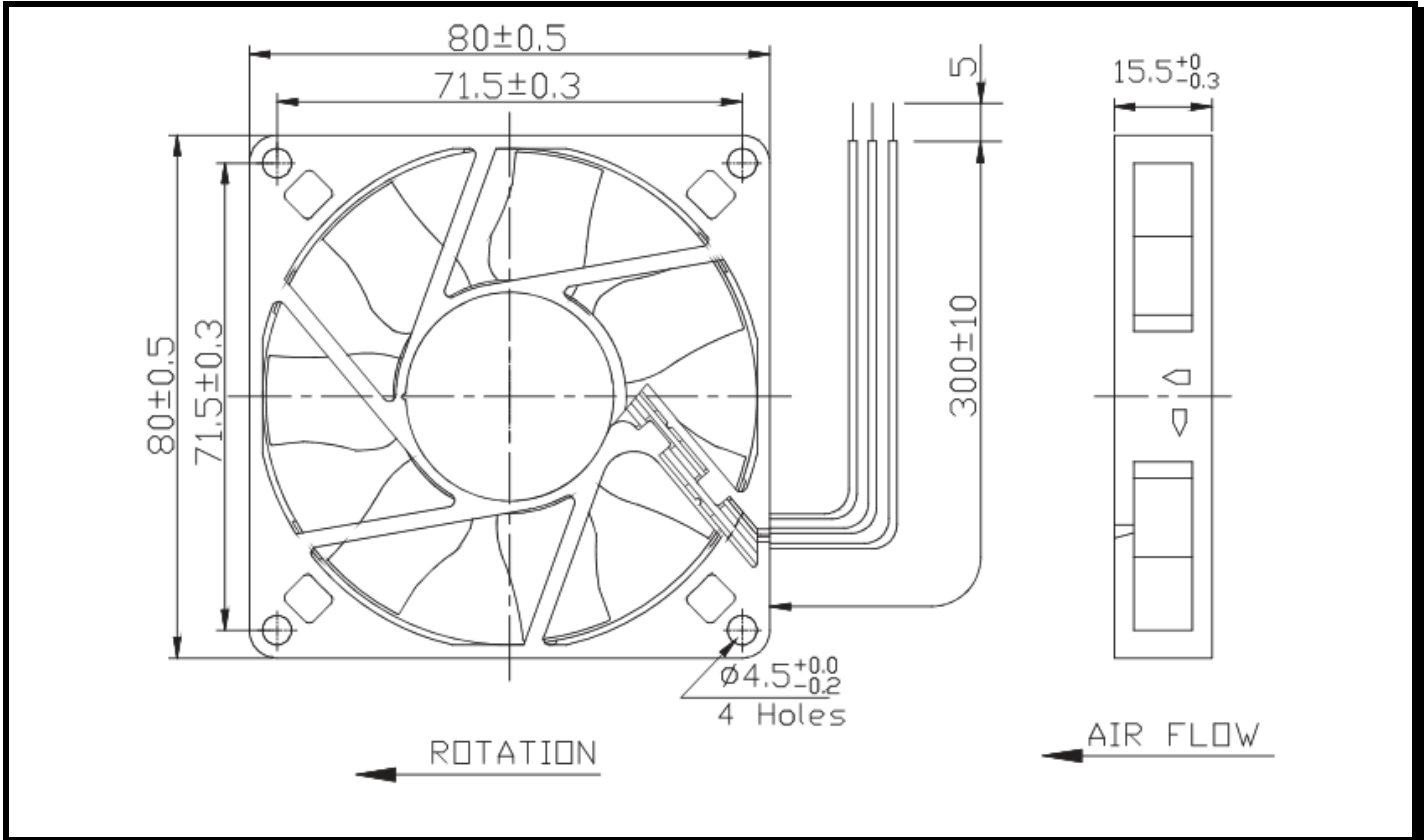

Motor:

Nominal Voltage	= 24 VDC
Nominal Running Current	= 0.05 Amps
Power Input	= 1.20 Watts
Speed	= 3000 RPM
Bearings	= Ball
Air Flow	= 29.58 CFM
Static Pressure:	= 0.12 Inch of H ₂ O
Acoustic	= 36 dB(A)
Weight	= 63.0 g

Construction:

Housing: UL94V-0 Glass Filled Polyester (P.B.T)
Impeller: UL94V-0 Glass Filled Polyester (P.B.T)

Life Expectancy:

This fan is designed for continuous duty life of 70,000 hours at 40°C.

Additional Features:

Brushless DC Motor
Locked Rotor Protection
Polarity Protected
Automatic Restart Capability
Operating Temperature: -10° C to 70° C
Storage Temperature: -40° C to 70° C

Termination:

300 ± 10 mm Lead wires, AWG 24, UL 1007

Agency Approvals:

UL, CUL, TUV, CE