

CRD1611-8W

8 Watt Reference Design

Features

- Quasi-resonant Flyback with Constant-current Output
- Flicker-free Dimming
- Line Voltage 230VAC, ±10%
- Rated Input Power: 8.0W
- Rated Output Power: 6.6W
- Output Voltage: 11.0V to 12.6V
- Efficiency: 83% at 550mA, for 4×LEDs in series
- Low Component Count
- Supports Cirrus Logic Product CS1611

General Description

The CRD1611-8W reference design demonstrates the performance of the CS1611 resonant mode AC/DC dimmable LED driver IC with a 550mA output driving 4×LEDs in series. It offers best-in-class dimmer compatibility with leading-edge, trailing-edge, and digital dimmers. The form factor is targeted to fit into many LED bulb applications (A19, PAR).

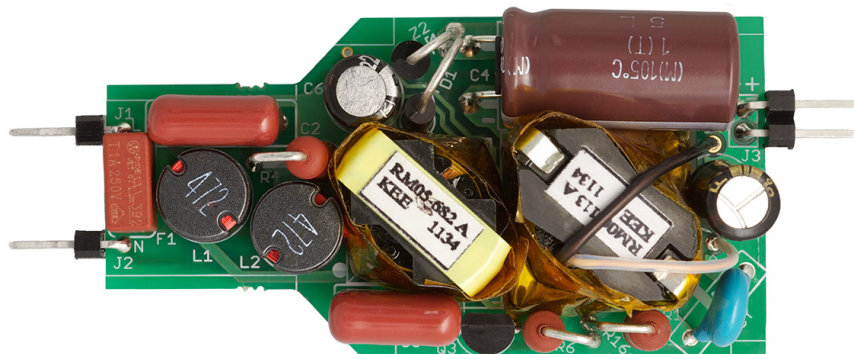
DIMENSIONS (OVERALL)

Length	Width	Height
2.284" (58mm) × 1.181" (29.9mm) × 0.652" (16.5mm)		

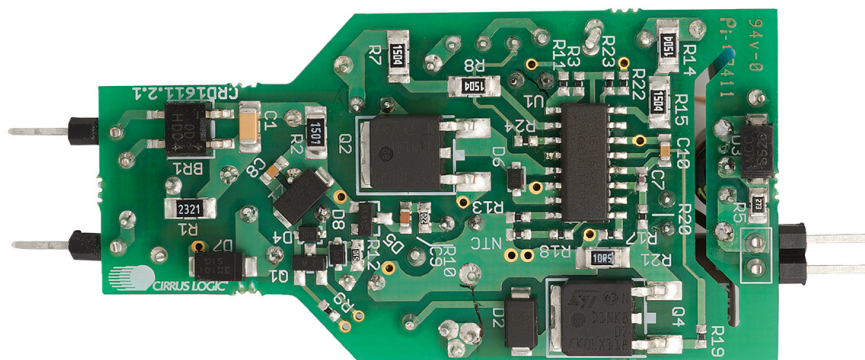
For more information, see Figure 3.

ORDERING INFORMATION

CRD1611-8W-Z 8 Watt Reference Design
Supports CS1611



Top



Bottom



IMPORTANT SAFETY INSTRUCTIONS

Read and follow all safety instructions prior to using this demonstration board.

This Engineering Evaluation Unit or Demonstration Board must only be used for assessing IC performance in a laboratory setting. This product is not intended for any other use or incorporation into products for sale.

This product must only be used by qualified technicians or professionals who are trained in the safety procedures associated with the use of demonstration boards.

⚠ DANGER Risk of Electric Shock

- The direct connection to the AC power line and the open and unprotected boards present a serious risk of electric shock and can cause serious injury or death. Extreme caution needs to be exercised while handling this board.
- Avoid contact with the exposed conductor or terminals of components on the board. High voltage is present on exposed conductor and it may be present on terminals of any components directly or indirectly connected to the AC line.
- Dangerous voltages and/or currents may be internally generated and accessible at various points across the board.
- Charged capacitors store high voltage, even after the circuit has been disconnected from the AC line.
- Make sure that the power source is off before wiring any connection. Make sure that all connectors are well connected before the power source is on.
- Follow all laboratory safety procedures established by your employer and relevant safety regulations and guidelines, such as the ones listed under, OSHA General Industry Regulations - Subpart S and NFPA 70E.

⚠ WARNING Suitable eye protection must be worn when working with or around demonstration boards. Always comply with your employer's policies regarding the use of personal protective equipment.

⚠ WARNING All components and metallic parts may be extremely hot to touch when electrically active.

Contacting Cirrus Logic Support

For all product questions and inquiries contact a Cirrus Logic Sales Representative. To find the one nearest to you go to www.cirrus.com

IMPORTANT NOTICE

Cirrus Logic, Inc. and its subsidiaries ("Cirrus") believe that the information contained in this document is accurate and reliable. However, the information is subject to change without notice and is provided "AS IS" without warranty of any kind (express or implied). Customers are advised to obtain the latest version of relevant information to verify, before placing orders, that information being relied on is current and complete. All products are sold subject to the terms and conditions of sale supplied at the time of order acknowledgment, including those pertaining to warranty, indemnification, and limitation of liability. No responsibility is assumed by Cirrus for the use of this information, including use of this information as the basis for manufacture or sale of any items, or for infringement of patents or other rights of third parties. This document is the property of Cirrus and by furnishing this information, Cirrus grants no license, express or implied under any patents, mask work rights, copyrights, trademarks, trade secrets or other intellectual property rights. Cirrus owns the copyrights associated with the information contained herein and gives consent for copies to be made of the information only for use within your organization with respect to Cirrus integrated circuits or other products of Cirrus. This consent does not extend to other copying such as copying for general distribution, advertising or promotional purposes, or for creating any work for resale.

CERTAIN APPLICATIONS USING SEMICONDUCTOR PRODUCTS MAY INVOLVE POTENTIAL RISKS OF DEATH, PERSONAL INJURY, OR SEVERE PROPERTY OR ENVIRONMENTAL DAMAGE ("CRITICAL APPLICATIONS"). CIRRUS PRODUCTS ARE NOT DESIGNED, AUTHORIZED OR WARRANTED FOR USE IN PRODUCTS SURGICALLY IMPLANTED INTO THE BODY, AUTOMOTIVE SAFETY OR SECURITY DEVICES, LIFE SUPPORT PRODUCTS OR OTHER CRITICAL APPLICATIONS. INCLUSION OF CIRRUS PRODUCTS IN SUCH APPLICATIONS IS UNDERSTOOD TO BE FULLY AT THE CUSTOMER'S RISK AND CIRRUS DISCLAIMS AND MAKES NO WARRANTY, EXPRESS, STATUTORY OR IMPLIED, INCLUDING THE IMPLIED WARRANTIES OF MERCHANTABILITY AND FITNESS FOR PARTICULAR PURPOSE, WITH REGARD TO ANY CIRRUS PRODUCT THAT IS USED IN SUCH A MANNER. IF THE CUSTOMER OR CUSTOMER'S CUSTOMER USES OR PERMITS THE USE OF CIRRUS PRODUCTS IN CRITICAL APPLICATIONS, CUSTOMER AGREES, BY SUCH USE, TO FULLY INDEMNIFY CIRRUS, ITS OFFICERS, DIRECTORS, EMPLOYEES, DISTRIBUTORS AND OTHER AGENTS FROM ANY AND ALL LIABILITY, INCLUDING ATTORNEYS' FEES AND COSTS, THAT MAY RESULT FROM OR ARISE IN CONNECTION WITH THESE USES.

Cirrus Logic, Cirrus, the Cirrus Logic logo designs, EXL Core, the EXL Core logo design, TruDim, and the TruDim logo design are trademarks of Cirrus Logic, Inc. All other brand and product names in this document may be trademarks or service marks of their respective owners.

1. INTRODUCTION

The CS1611 is a 230VAC quasi-resonant flyback mode dimmable LED controller IC. The CS1611 uses a digital control algorithm that is optimized for high efficiency and >0.9 power factor over an input voltage range (207VAC to 253VAC). The CS1611 integrates a critical conduction mode (CRM) boost converter that provides power factor correction and dimmer compatibility with a constant output current, quasi-resonant flyback stage. An adaptive dimmer compatibility algorithm controls the boost stage and dimmer compatibility operation mode to enable flicker-free operation to $<2\%$ output current with leading-edge, trailing-edge, and digital dimmers.

The CRD1611-8W board is optimized to deliver low system cost in a high-efficiency, flicker-free, phase-dimmable, solid-state lighting (SSL) solution for incandescent lamp replacement applications. The feedback loop is closed through an integrated digital control system within the IC. The variation in switching frequency also provides a spread-frequency spectrum, thus minimizing the conducted EMI filtering requirements. Protection algorithms such as output open/short, current-sense resistor open/short, and overtemperature thermistors protect the system during abnormal conditions. Details of these features are provided in the CS1611 data sheet.

The CRD1611-8W board demonstrates the performance of the CS1611. This reference board has been designed for an output load of $4\times$ LEDs in series at 550mA (12.0V typical).

This document provides the schematic for the board. It includes oscilloscope screen shots that indicate various operating waveforms. Graphs are also provided that document the performance of the board in terms of Efficiency vs. Line Voltage, Output Current vs. Line Voltage, and Output Current vs. Dim Angle for the CS1611 dimmable LED controller IC. Extreme caution needs to be exercised while handling this board. This board is to be used by trained professionals only.

2. SCHEMATIC

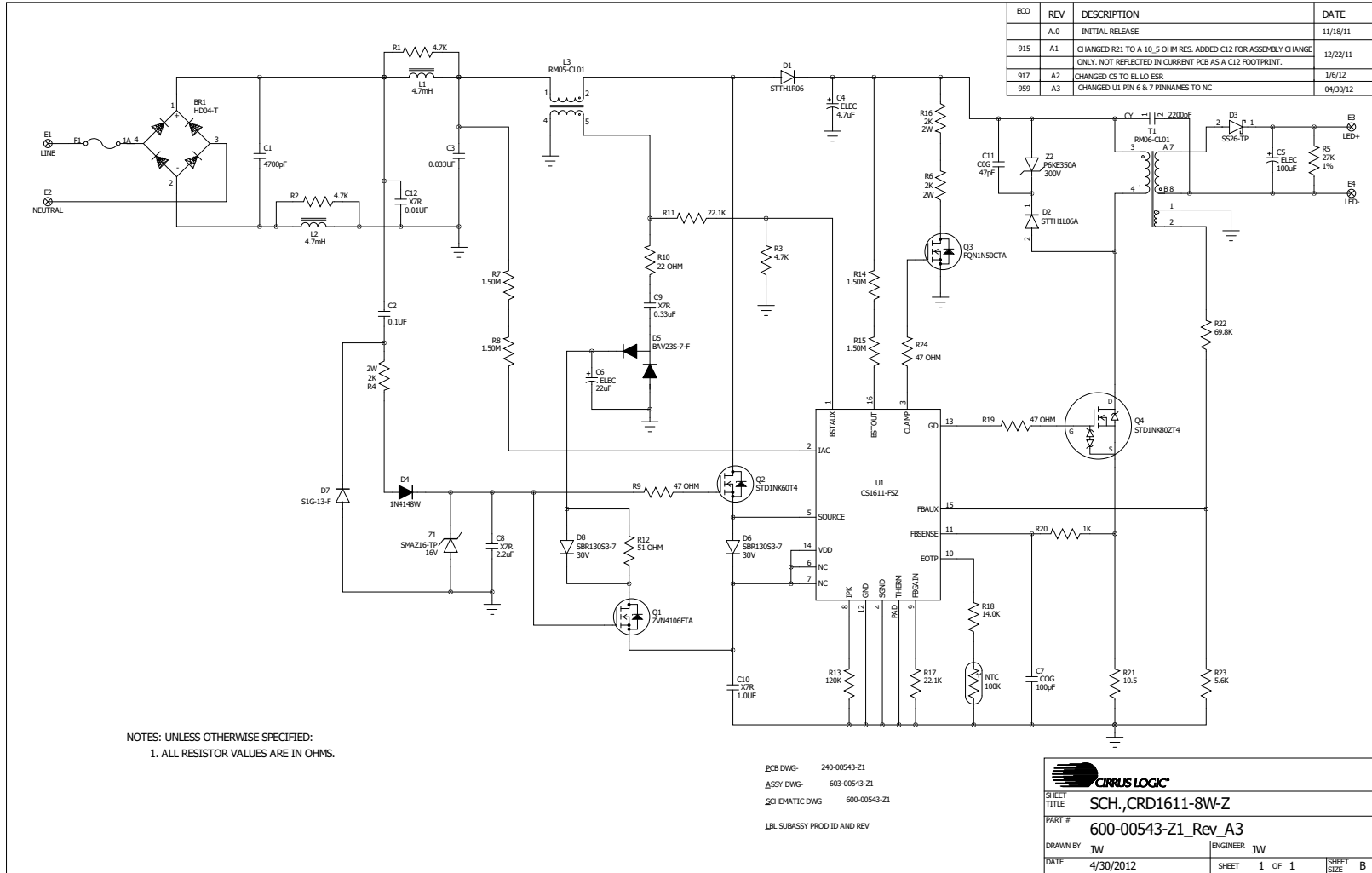


Figure 1. Schematic

3. BILL OF MATERIALS

Item	Rev	Description	Qty	Reference Designator	MFG	MFG P/N
1	A	DIODE RECT 400V 0.8A NPb MINIDIP	1	BR1	DIODES INC	HD04-T
2	A	CAP 4700PF ±10% 1000V X7R NPb 1206	1	C1	MURATA	GRM31BR73A472KW01L
3	A	CAP 0.1UF ±5% 400V MTL FLM RAD	1	C2	Panasonic	ECQE4104JF
4	A	CAP 0.033uF ±10% 400V MTL NPb RAD	1	C3	PANASONIC	ECQE4333KF
5	A	CAP 4.7uF 450V ±20% NPb RAD 10x20	1	C4	PANASONIC-ECG	ECA2WHG4R7
6	A	CAP 100uF ±20% 25V EL LO ESR NPb RD	1	C5	PANASONIC	EEUFM1E101
7	A	CAP 22uF ±20% 35V ELEC NPb RAD	1	C6	PANASONIC	EEA-GA1V220H
8	A	CAP 100pF ±5% 50V COG NPb 0603	1	C7	KEMET	C0603C101J5GAC
9	A	CAP 2.2uF ±10% 25V X7R NPb 0805	1	C8	MURATA	GRM21BR71E225KA73L
10	A	CAP 0.33UF ±10% 50V X7R NPb 0603	1	C9	TDK	C1608X7R1H334K
11	A	CAP 1.0uF 10% 25V X7R NPb 0603	1	C10	MURATA	GRM188R71E105KA12D
12	A	CAP 47pF ±5% 1000V COG NPb 1206	1	C11	JOHANSON DIELECTRICS	102R18N470JV4E
12a	A	CAP 0.01uF ±10% 630V X7R NPb 1206	1	C12	MURATA	GRM31BR72J103KW01L
13	A	CAP 2200PF +80/-20% 2KV CER NPb RAD	1	CY	MURATA	DEBE33D222ZA2B
14	A	DIODE FAST 600V 1A NPb DO-41	1	D1	ST	STTH1R06
15	A	DIODE ULT FAST 600V 1A NPb SMA	1	D2	ST MICROELECTRONICS	STTH1L06A
16	A	DIODE SKY RECT 60V 2A NPb DO-214AC	1	D3	MICRO COMMERCIAL(MCC)	SS26-TP
17	A	DIODE FAST SW 75V 350mW NPb SOD123	1	D4	DIODES INC	1N4148W-7-F
18	A	DIODE SWT 250V 0.4A NPb SOT-23	1	D5	DIODES INC	BAV23S-7-F
19	A	DIODE RECT 30V 1A NPb SOD-323	2	D6 D8	DIODES INC	SBR130S3-7
20	A	DIODE RECT 400V 1A NPb SMA	1	D7	DIODES INC	S1G-13-F
21	A	FUSE 1A 250V TLAG NPb RAD	1	F1	LITTLE FUSE	39211000440
22	A	IND 4.7mH ±10% 17.6 OHM 350 DIA TH	2	L1 L2	COILCRAFT	RFB0807-472L
23	A	XFMR 6.8mH ±10% 10KHz NPb TH	1	L3	KUNSHAN EAGERNESS	RM05-CL01
24	A	THERM 100K OHM ±5% 0.10mA NPb 0603	1	NTC	MURATA	NCP18WF104J03RB
25	A	TRAN MOSFET nCH 60V.2A NPb SOT23-3	1	Q1	DIODES INC	ZVN4106FTA
26	A	TRAN MOSFET nCH 1.0A 600V NPb DPAK	1	Q2	ST MICROELECTRONICS	STD1NK60T4
27	A	TRAN MOSFET nCH 0.38A 500V NPb TO92	1	Q3	FAIRCHILD	FQN1N50CTA
28	A	TRAN MOSFET nCH 1A 800V NPb DPAK	1	Q4	ST MICROELECTRONICS	STD1NK80ZT4
29	A	RES 4.7k OHM 1/4W ±5% 1206 FILM	2	R1 R2	DALE	CRCW1206472J
30	A	RES 4.70K OHM 1/10W ±1% NPb 0603	1	R3	PANASONIC	ERJ3EKF4701V
31	A	RES PWR 2.0K OHM 2W ±5% NPb AXL	3	R4 R6 R16	VISHAY	PR02000202001JR500
32	A	RES 27K OHM 1/8W ±1% NPb 0805	1	R5	PANASONIC	ERJ6ENF2702V
33	A	RES 1.50M OHM 1/4W ±1% NPb 1206	4	R7 R8 R14 R15	PANASONIC	ERJ8ENF1504V
34	A	RES 47 OHM 1/10W ±1% NPb 0603	3	R9 R19 R24	PANASONIC	ERJ3EKF47ROV
35	A	RES 22.0 OHM 1/10W ±1% NPb 0603	1	R10	PANASONIC	ERJ3EKF22ROV
36	A	RES 22.1k OHM 1/10W ±1% NPb 0603	2	R11 R17	DALE	CRCW060322K1FKEA
37	A	RES 51.0 OHM 1/10W ±1% NPb 0603	1	R12	PANASONIC	ERJ3EKF51ROV
38	A	RES 120K OHM 1/10W ±1% NPb 0603	1	R13	PANASONIC	ERJ3EKF1203V
39	A	RES 14k OHM 1/10W ±1% NPb 0603 FILM	1	R18	DALE	CRCW060314K0FKEA
40	A	RES 1k OHM 1/10W ±1% NPb 0603 FILM	1	R20	DALE	CRCW06031K00FKEA
41	A	RES 10.5 OHM 1/4W ±1% NPb 1206	1	R21	DALE	CRCW120610R5FKEA
42	A	RES 69.8k OHM 1/10W ±1% NPb 0603	1	R22	DALE	CRCW060369K8FKEA
43	A	RES 5.6k OHM 1/10W ±5% NPb 0603 FLM	1	R23	DALE	CRCW06035K60JNEA
44	A	XFMR 14.5mH ±10% 10KHz NPb TH	1	T1	KUNSHAN EAGERNESS	RM06-CL01
45	B1	IC CRUS DIMMER LED DRVr NPb SOIC16	1	U1	CIRRUS LOGIC	CS1611-FSZ/B1
46	A	DIODE ZENER 16V 1W NPb DO-214AC	1	Z1	MICRO COMMERCIAL	SMAZ16-TP
47	A	DIODE TVS 300V 600W NPb DO-204AC	1	Z2	LITTELFUSE	P6KE350A

Figure 2. Bill of Materials

4. BOARD LAYOUT

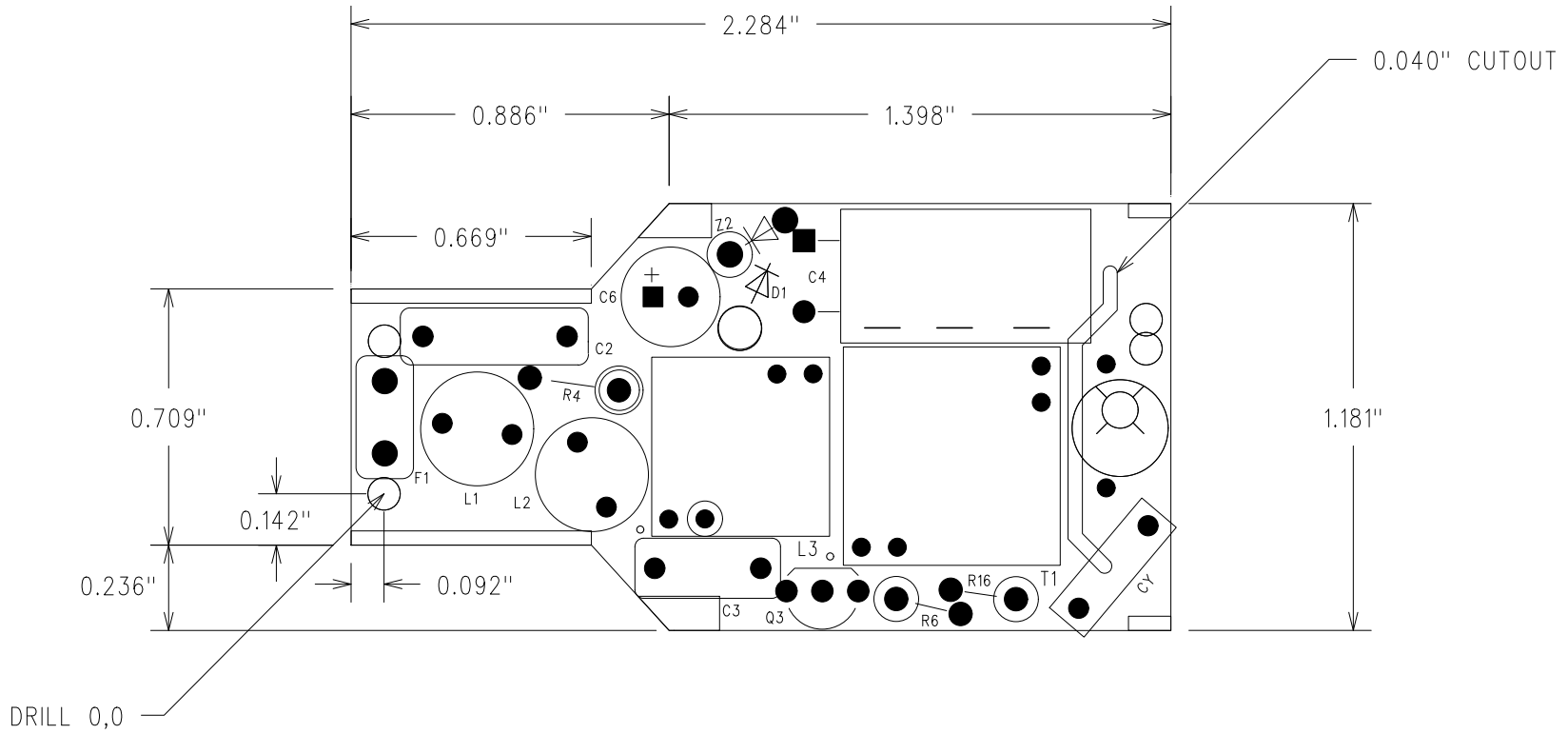


Figure 3. PCB Dimensions

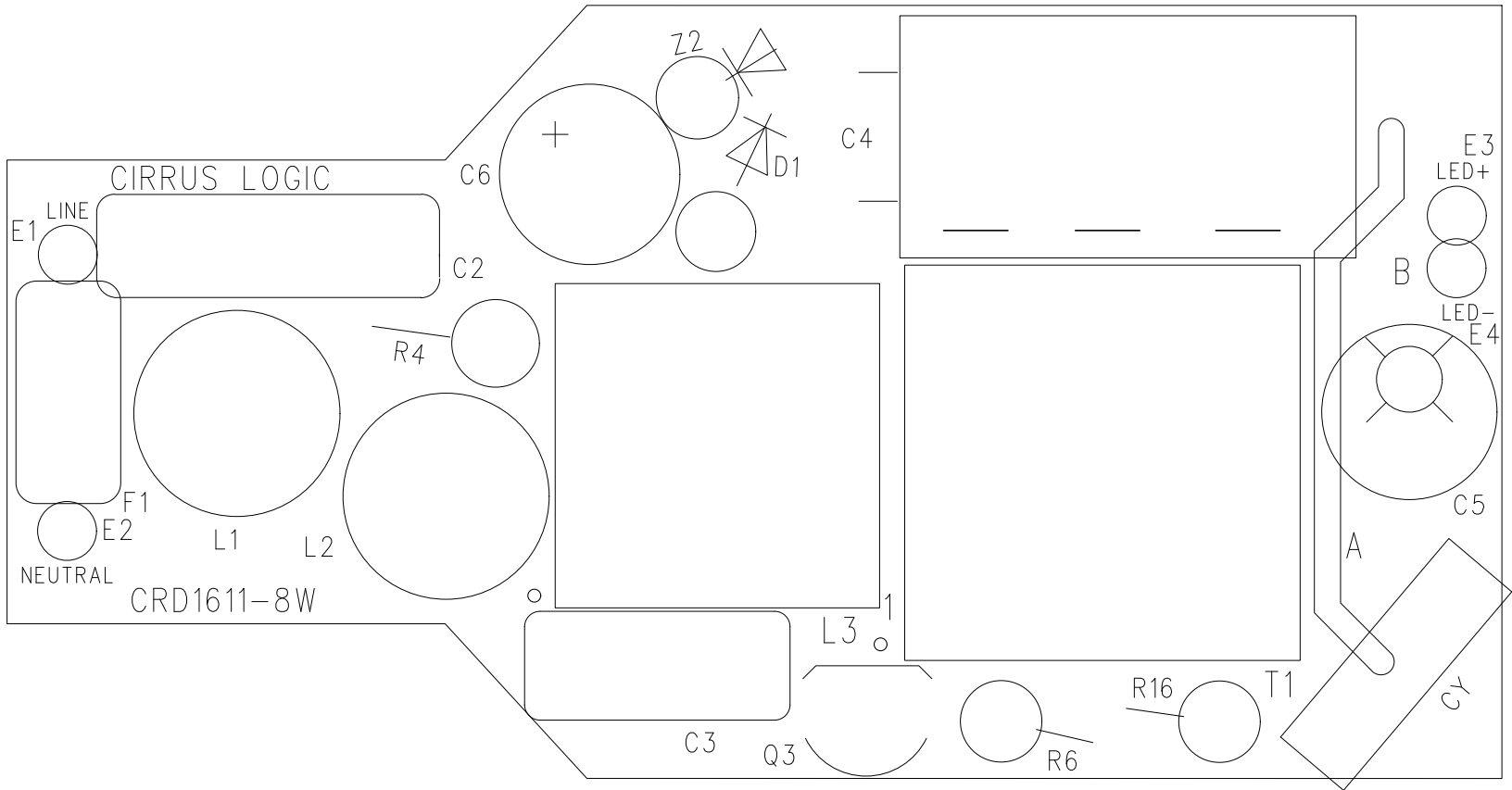


Figure 4. Top Silkscreen

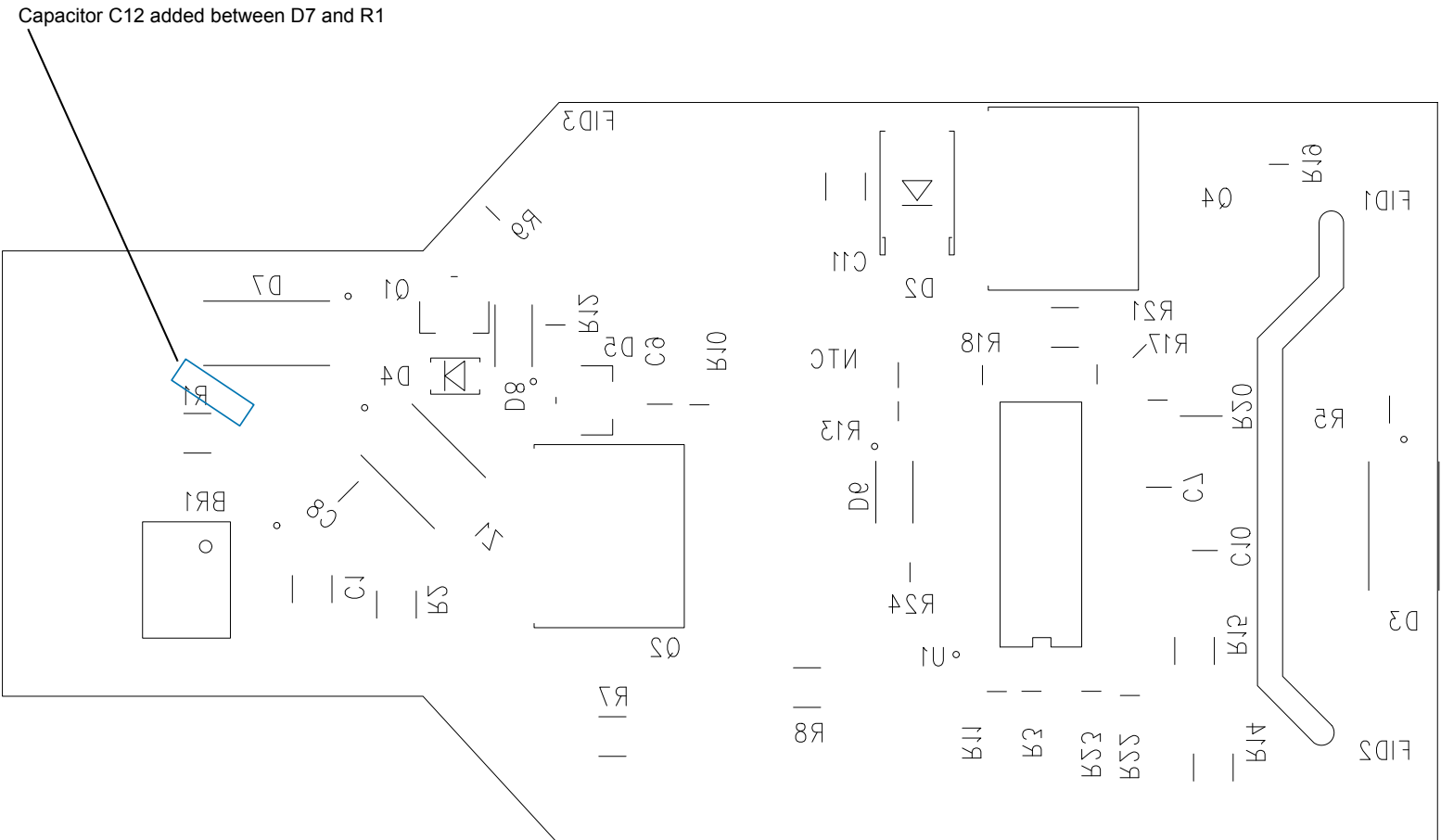


Figure 5. Bottom Silkscreen

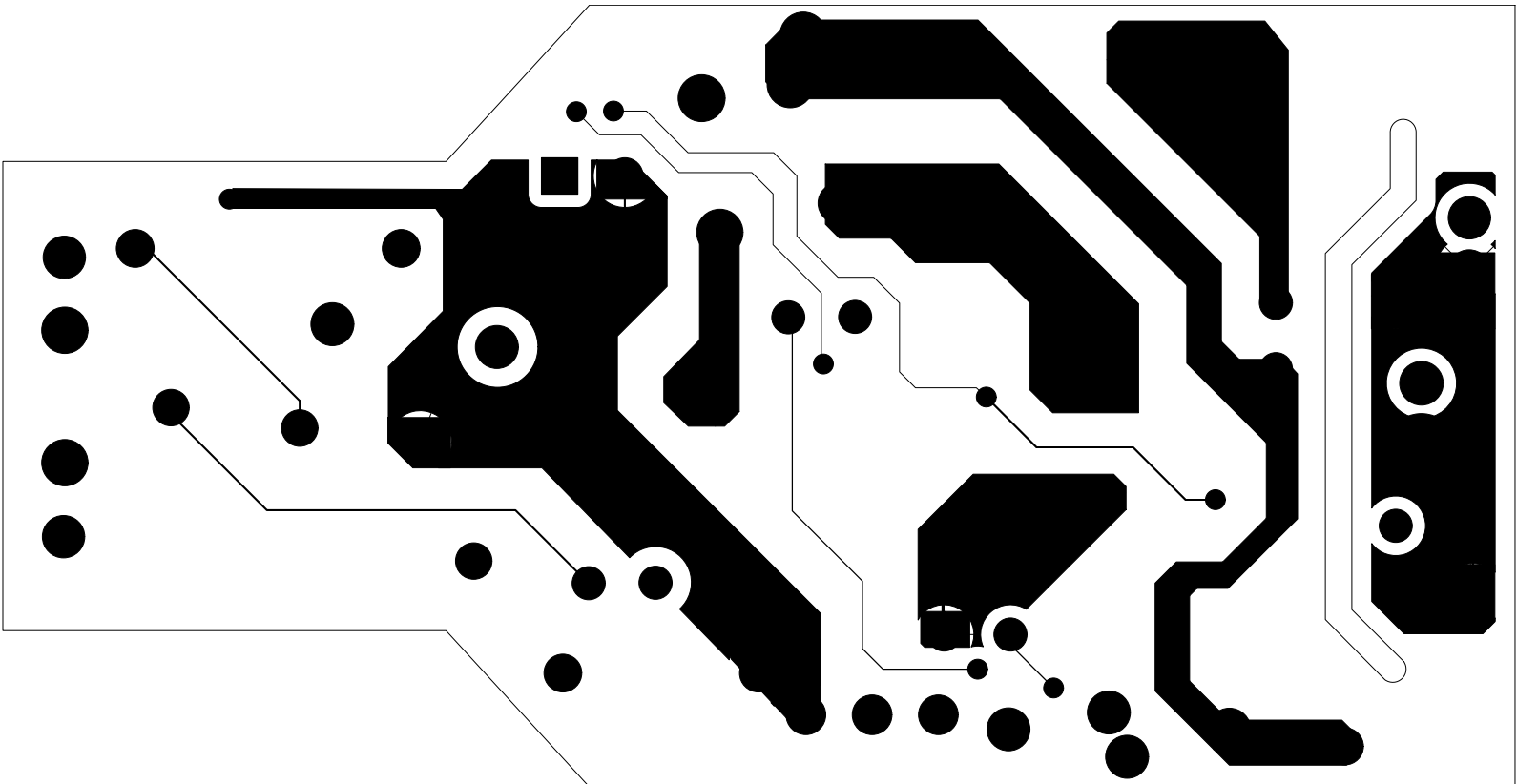


Figure 6. Top Routing

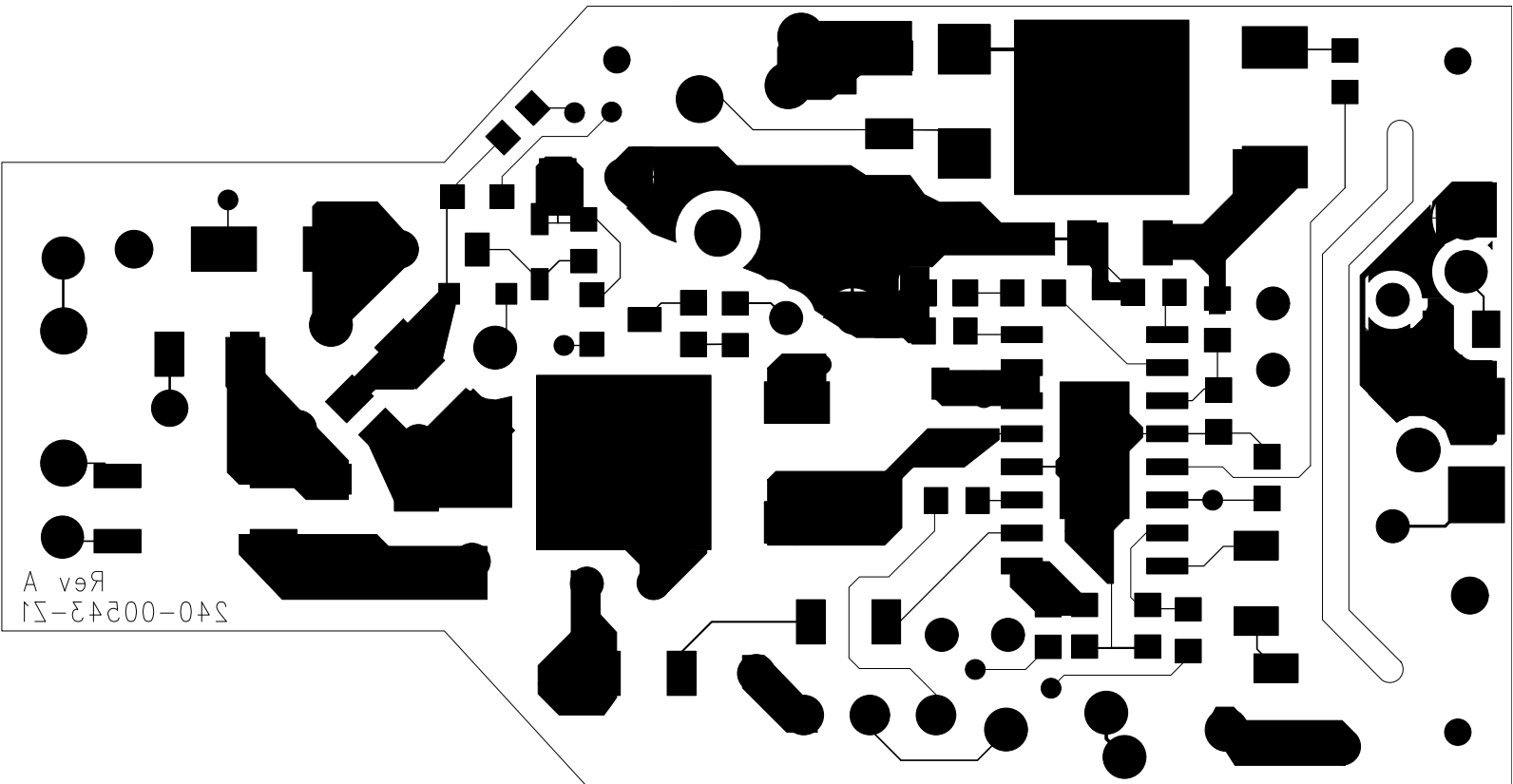


Figure 7. Bottom Routing

5. THERMAL IMAGING

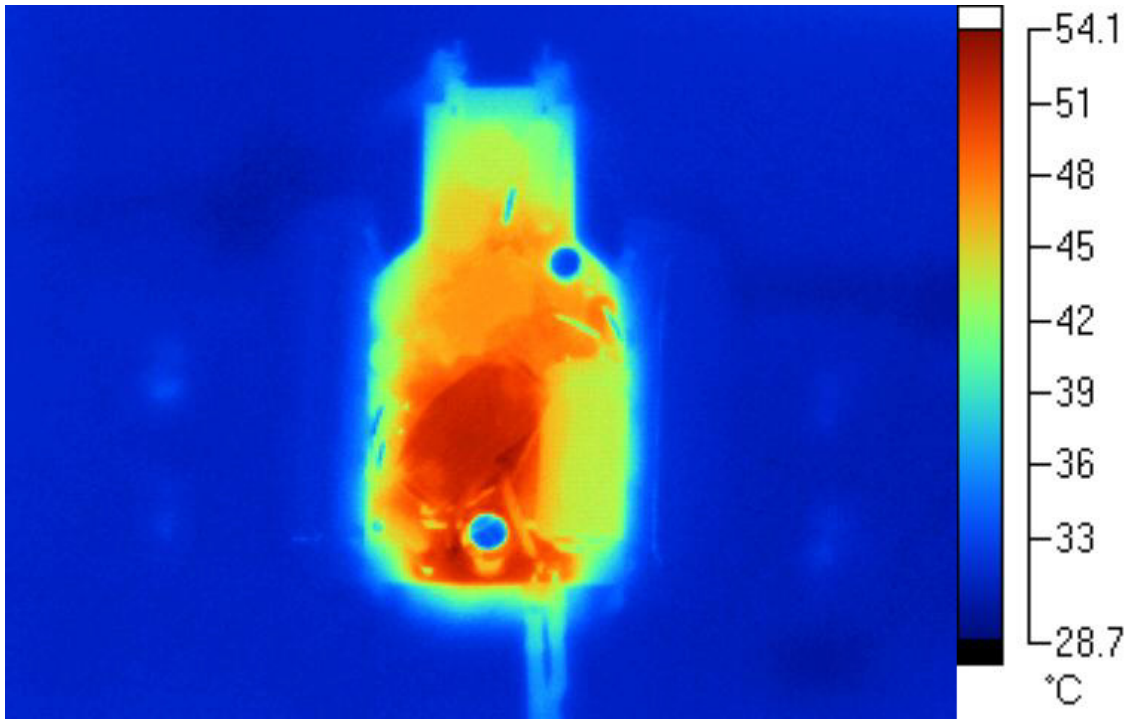


Figure 8. Top Thermal

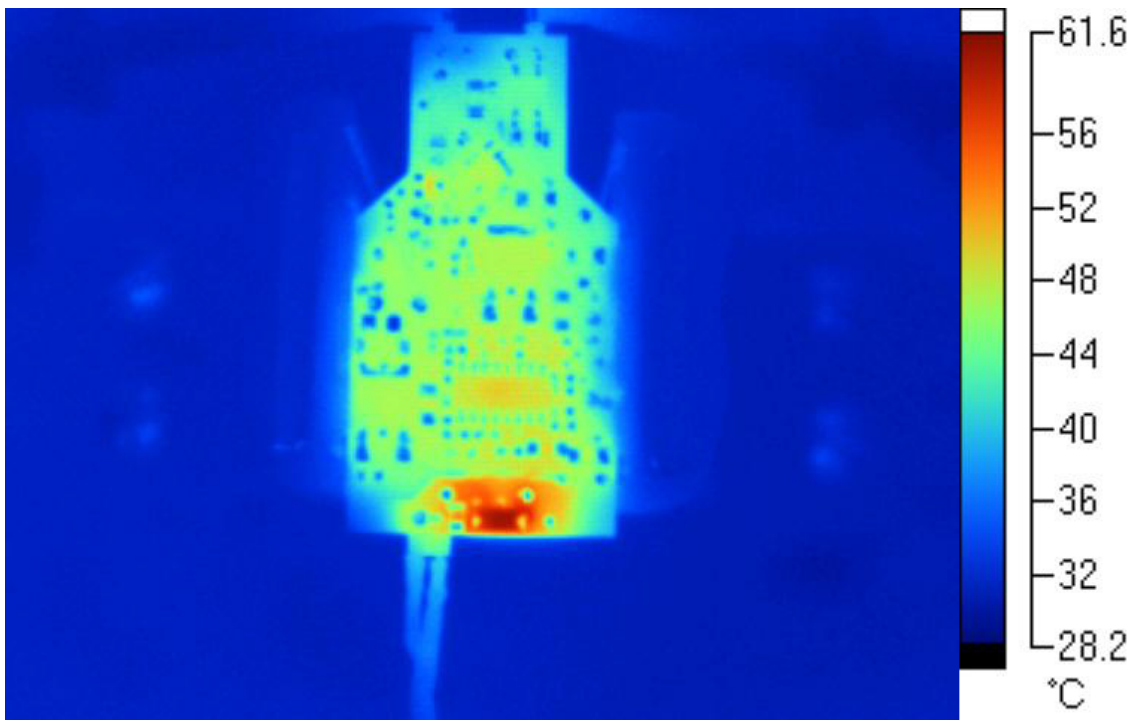


Figure 9. Bottom Thermal

6. DIMMER COMPATIBILITY - PAR 16 WITH CS1611 (220V - 240V)

Input Power	7.7W	Dimmer Compatibility	972/1008	Efficiency	82.9%
-------------	-------------	----------------------	-----------------	------------	--------------

Date	12/20/2011	Power Factor ^{1,6}	0.90
Vendor	Cirrus Logic	IEC-61000-3-2 Compliant (Y/N) ^{3,6}	Y
Input Voltage	230V	EN55015 Compliant (Y/N)	Y
Form Factor	PAR 16	Nominal Input Power (W) ^{1,6}	7.7
Model #	CRD1611-8W	Maximum Input Power (W) ^{2,6}	8.8
IC	CS1611	Output Voltage (V) ^{1,4}	11.8
Topology	Boost/Flyback	Output Current (mA) ^{1,4}	540
Isolation (Y/N)	Y	Output Current Ripple ≤ 120Hz (mA) ^{1,5}	0
Compatibility Spec.	1.0	Output Power (W) ^{1,6}	6.4
		Efficiency (%)	82.9

Dimmer Type	Flicker Free Steady-state			Monotonic Dimming			Max I _{out} (mA)			Min I _{out} (mA)			Total
	# of Lamps			# of Lamps			# of Lamps			# of Lamps			
	1	5	10	1	5	10	1	5	10	1	5	10	
Berker - Leading/Trailing Edge	Y	Y	N	Y	Y	N	478	479	476	10	9	220	17
Bticino - Trailing Edge	Y	Y	Y	Y	Y	Y	270	241	212	9	9	10	21
Bull - Leading Edge	Y	Y	Y	Y	Y	Y	476	477	477	9	9	9	24
Busch - Leading Edge	Y	Y	Y	Y	Y	Y	476	477	476	9	9	9	24
Busch - Leading Edge	Y	Y	Y	Y	Y	Y	476	477	476	9	9	9	24
Busch - Trailing Edge	Y	Y	Y	Y	Y	Y	478	479	478	9	9	9	24
Busch - Trailing Edge	Y	Y	Y	Y	Y	Y	478	479	478	9	9	9	24
Chint New - Leading Edge	Y	Y	Y	Y	Y	Y	476	476	477	9	9	9	24
Chisen - Leading Edge	Y	Y	Y	Y	Y	Y	476	476	477	9	9	9	24
Chisen - Leading Edge	Y	N	Y	Y	Y	Y	476	476	477	9	9	9	19
Clipsal - Trailing Edge	Y	Y	Y	Y	Y	Y	476	476	476	9	9	9	24
Clipsal - Trailing Edge	Y	Y	Y	Y	Y	Y	476	476	475	9	9	9	24
Clipsal - Leading Edge	Y	Y	Y	Y	Y	Y	476	476	477	9	9	9	24
CLSEN - Leading Edge	Y	Y	Y	Y	Y	Y	476	476	476	9	8	9	24
Cshyh - Leading Edge	Y	Y	Y	Y	Y	Y	476	475	476	9	9	9	24
Dbang - Leading Edge	Y	Y	Y	Y	Y	Y	476	476	476	15	32	31	21
Elro - Twilight Sensor	Y	Y	Y	Y	Y	Y	475	475	474	0	0	0	24
Elro - Motion Sensor	Y	Y	Y	Y	Y	Y	475	476	474	0	0	0	24
Elro - Twilight Sensor	Y	Y	Y	Y	Y	Y	475	474	474	0	0	0	24
Futina - Leading Edge	Y	Y	Y	Y	Y	Y	476	476	477	9	10	10	24
Gangben - Leading Edge	Y	Y	Y	Y	Y	Y	500	500	500	10	10	10	24
Gira - Leading Edge	Y	Y	Y	Y	Y	Y	477	477	476	11	11	12	24
Jung - Leading/Trailing Edge	Y	Y	Y	Y	Y	Y	478	479	476	9	9	20	23

Dimmer Type	Flicker Free Steady-state			Monotonic Dimming			Max I _{out} (mA)			Min I _{out} (mA)			Total
	# of Lamps			# of Lamps			# of Lamps			# of Lamps			
	1	5	10	1	5	10	1	5	10	1	5	10	
Legrand - Leading/Trailing Edge	Y	Y	Y	Y	Y	Y	476	477	477	9	9	9	24
Leiben - Leading Edge	Y	Y	Y	Y	Y	Y	476	475	476	9	12	12	24
Lonon - Leading Edge	Y	Y	Y	Y	Y	Y	475	475	476	9	9	9	24
Lutron - Leading Edge	Y	Y	Y	Y	Y	Y	476	477	476	9	9	9	24
Lutron - Leading Edge	Y	Y	Y	Y	Y	Y	421	423	420	9	9	9	21
Merten - Leading Edge	Y	Y	Y	Y	Y	Y	476	477	476	9	9	9	24
Merten - Trailing Edge	Y	Y	Y	Y	Y	Y	432	417	400	9	9	9	21
MK - Leading Edge	Y	Y	Y	Y	Y	Y	475	475	476	9	9	9	24
Opus - Leading Edge	Y	Y	Y	Y	Y	Y	476	477	475	27	25	27	21
Opus - Leading Edge	Y	Y	Y	Y	Y	Y	476	477	475	9	9	9	24
OVE - Trailing Edge	Y	Y	N	Y	Y	N	478	470	0	9	10	-	16
Siemens - Leading Edge	Y	Y	Y	Y	Y	Y	476	475	476	9	9	9	24
Songri - Leading Edge	Y	Y	Y	Y	Y	Y	476	475	476	9	12	10	24
T&J - Leading Edge	Y	Y	Y	Y	Y	Y	476	475	476	9	12	9	24
T&J - Leading Edge	Y	Y	Y	Y	Y	Y	475	475	476	10	9	9	24
TCL - Leading Edge	Y	Y	Y	Y	Y	Y	476	475	476	9	9	9	24
TNC - Leading Edge	Y	Y	Y	Y	Y	Y	475	475	476	9	9	9	24
Wuyun - Leading Edge	Y	Y	Y	Y	Y	Y	476	477	474	9	9	9	24
Wuyun - Trailing Edge	Y	Y	Y	Y	Y	Y	478	478	476	9	9	9	24

Overall Total 972

- Notes:
1. Tested at nominal input voltage, nominal input frequency and without a dimmer after soaking for 15 minutes
 2. Tested at nominal input voltage, nominal input frequency and with a dimmer after soaking for 15 minutes
 3. Compliant with IEC 61000-3-2 Class C < 25W
 4. Average
 5. Peak-to-peak
 6. Measured with Chroma 66202 Power Analyzer

7. INDUCTOR CONSTRUCTION

The CRD1611-8W includes a critical conduction mode (CRM) boost converter that provides power factor correction and dimmer compatibility with a constant output current, quasi-resonant flyback stage. The following sections describe the boost and flyback inductors installed on the CRD1611-8W.

7.1 Boost Inductor

The CS1611 uses an adaptive dimmer compatibility algorithm to control the boost inductor stage, which guarantees dimmer compatibility operation plus enables flicker-free operation with leading-edge, trailing-edge, and digital dimmers (dimmers with an integrated power supply). The boost auxiliary winding is used for zero-current detection (ZCD) and supplies power to the CS1611.

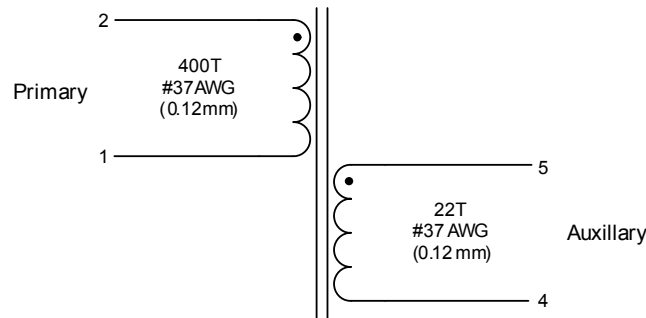


Figure 10. Boost Inductor Schematic

7.1.1 Electrical Specifications

Characteristics conditions:

- Operating temperature range: -25 °C to +120 °C (including coil heat)

Parameter	Condition	Symbol	Min	Typ	Max	Unit
Boost Inductor						
Primary Inductance (Note 7)	$f_{\text{resonant}} = 10\text{kHz}$, 0.3V at 20°C	L_p	6.12	6.8	7.48	mH
Primary DC Resistance (Note 7)	$t_{\text{DCR}} = 20^\circ\text{C}$		12	15	18	Ω
Auxiliary DC Resistance (Note 8)	$t_{\text{DCR}} = 20^\circ\text{C}$		0.84	1.05	1.26	Ω

- Notes:
7. Measured across pins 1 and 2.
 8. Measured across pins 5 and 4.

7.2 Flyback Transformer

The flyback transformer stage is a quasi-resonant peak current-regulated DC-DC converter capable of delivering the highest possible efficiency with constant current output while minimizing line frequency ripple. The auxiliary winding is used for zero-current detection and overvoltage protection.

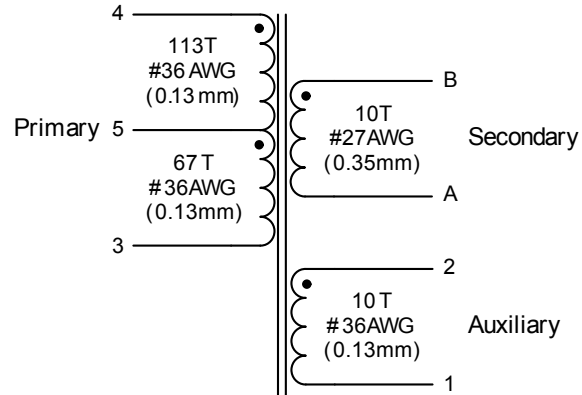


Figure 11. Flyback Transformer Schematic

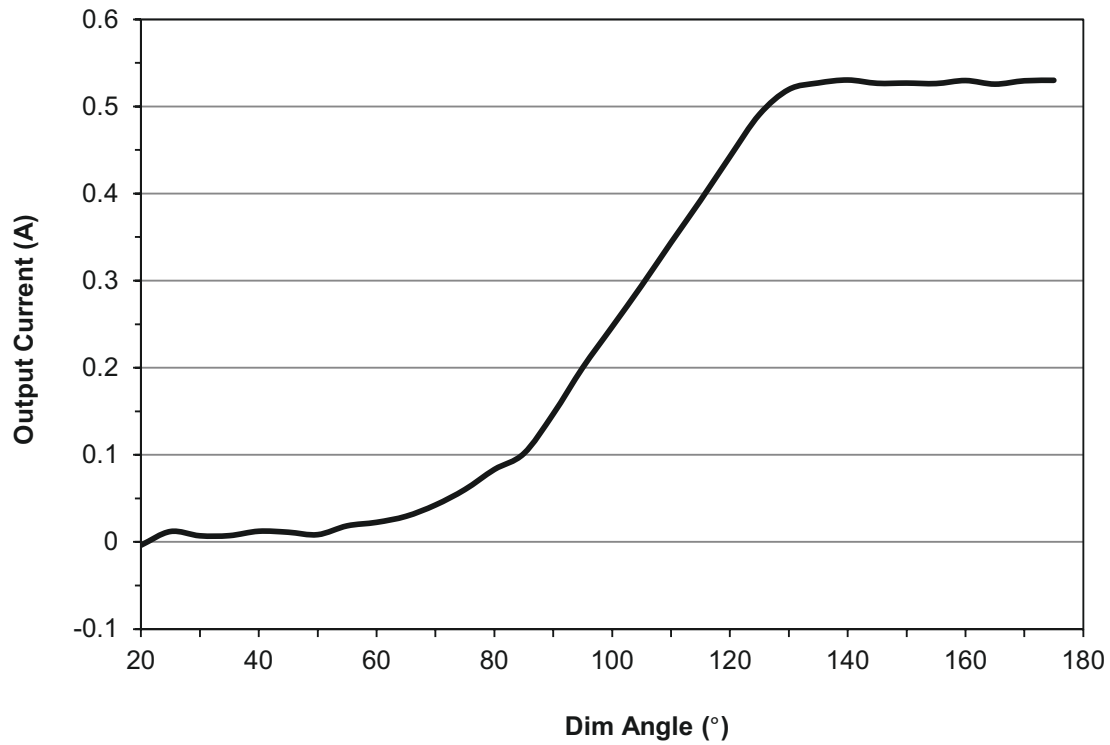
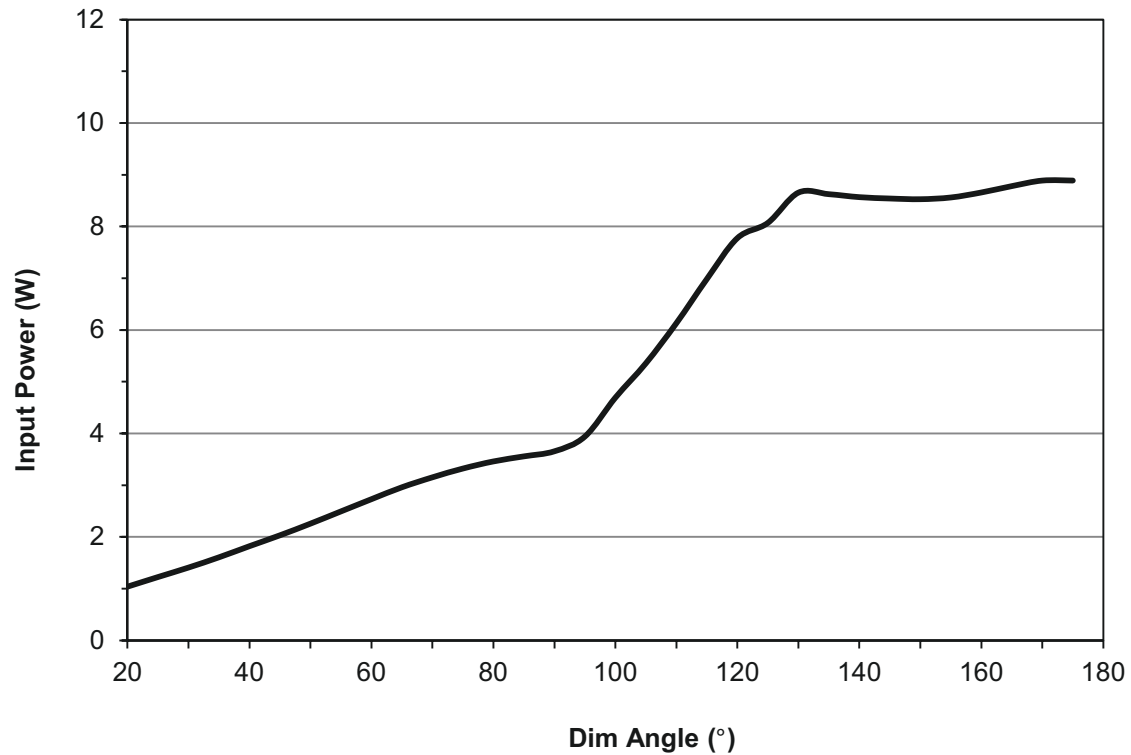
7.2.1 Electrical Specifications

Characteristics conditions:

- Operating temperature range: -25 °C to +120 °C (including coil heat)

Parameter	Condition	Symbol	Min	Typ	Max	Unit
Flyback Transformer						
Electrical Strength (Note 9)	$f_{\text{operate}}=50/60\text{Hz}$		-	4K	-	V_{RMS}
Primary Inductance (Note 10)	$f_{\text{resonant}}=10\text{kHz}$, 0.3V at 20°C	L_P	13.05	14.5	15.95	mH
Primary Leakage Inductance (Note 10)	$f_{\text{resonant}}=10\text{kHz}$, 0.3V at 20°C	L_K	-	106	-	μH
Primary DC Resistance (Note 10)	$t_{\text{DCR}}=20^\circ\text{C}$		5.25	7.0	8.75	Ω
Secondary DC Resistance (Note 11)	$t_{\text{DCR}}=20^\circ\text{C}$		-	120	-	m Ω
Auxiliary DC Resistance (Note 12)	$t_{\text{DCR}}=20^\circ\text{C}$		-	400	-	m Ω

- Notes:
9. Time = 2sec.
 10. Measured across pins 3 and 4.
 11. Measured across pins B and A.
 12. Measured across pins 2 and 1.

8. PERFORMANCE PLOTS

Figure 12. Typical Output Current vs. Dim Angle

Figure 13. Typical Input Power vs. Dim Angle

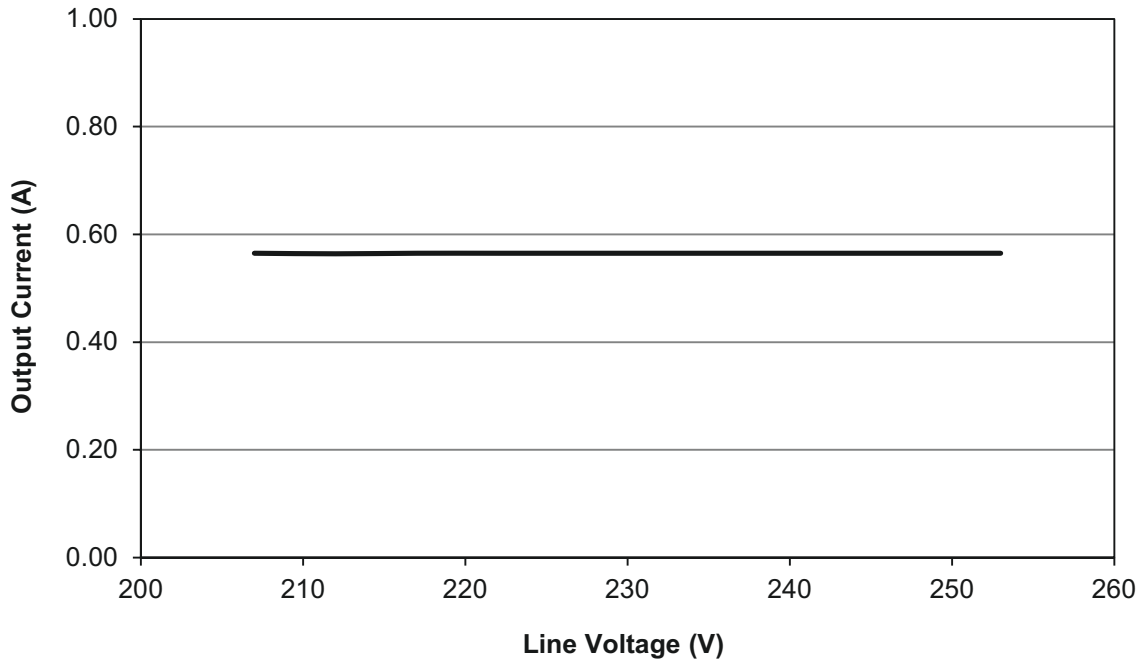


Figure 14. Output Current vs. Line Voltage

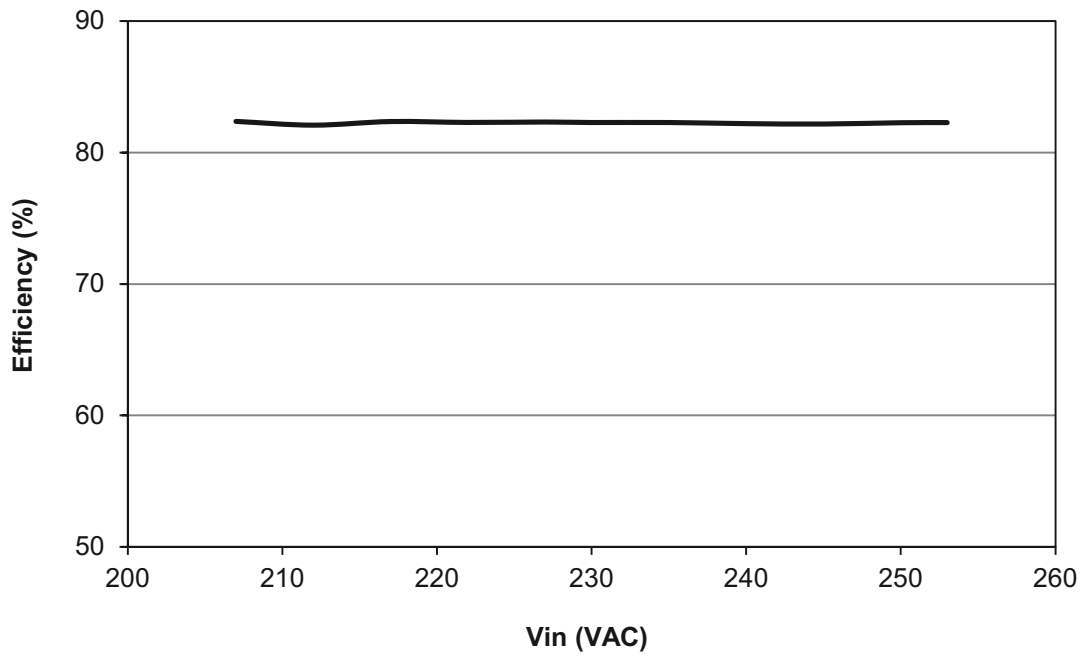


Figure 15. Typical Efficiency vs. Line Voltage

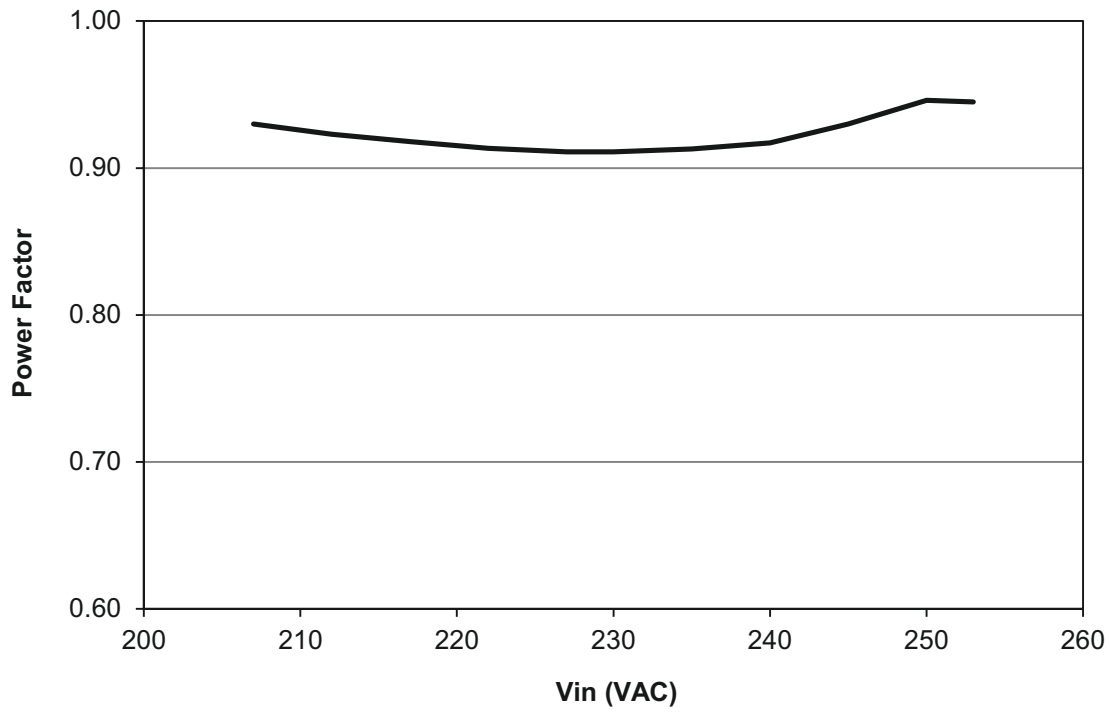
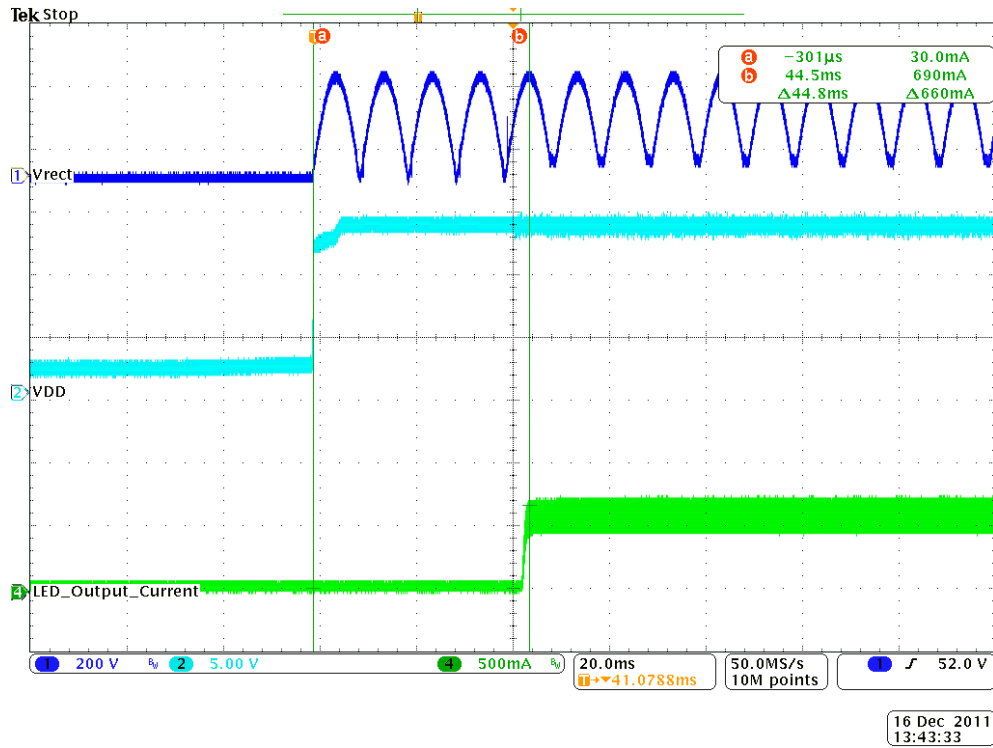
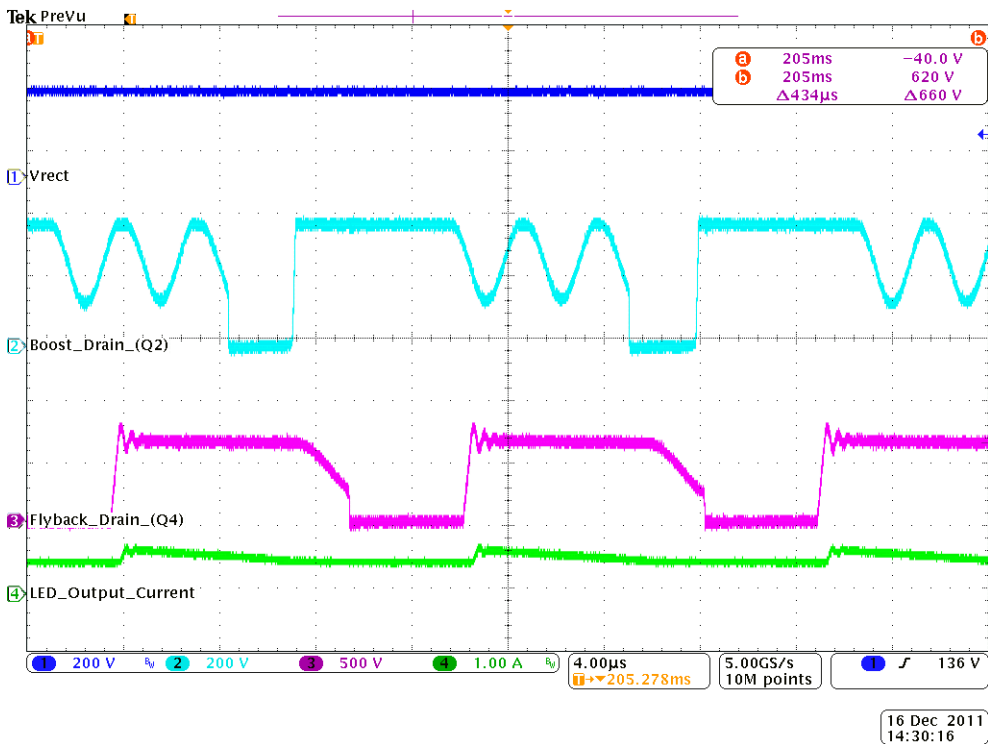


Figure 16. Power Factor vs. Line Voltage, 207VAC to 253VAC


Figure 17. No-dimmer Mode, Startup 230VAC

Figure 18. No-dimmer Mode, Steady-state, 230VAC

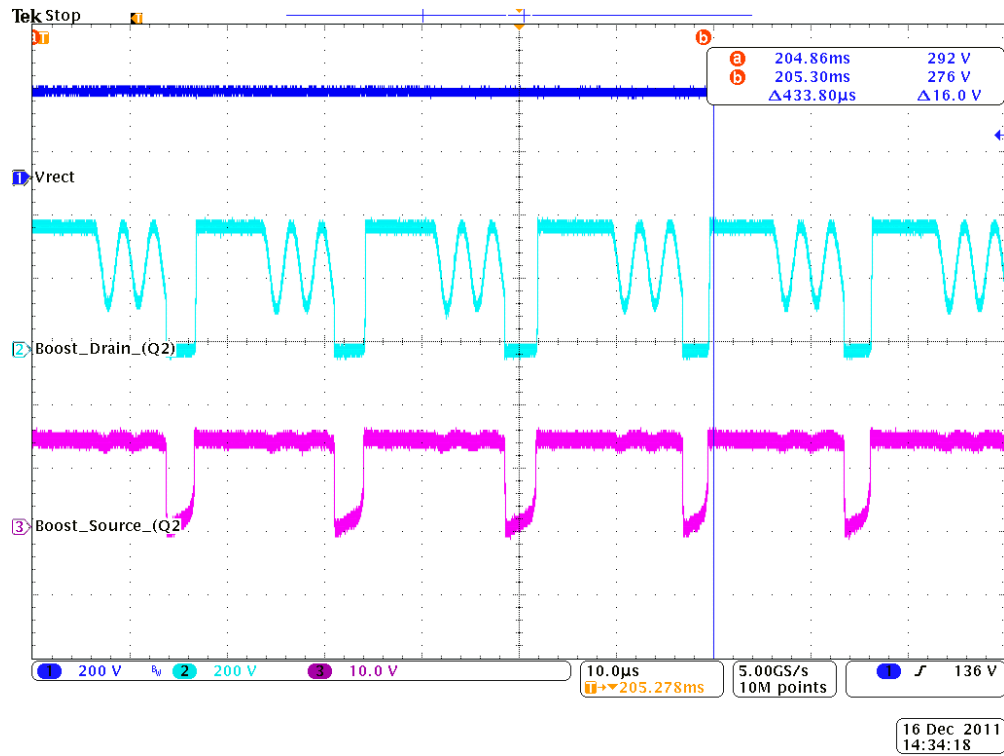


Figure 19. Boost FET, Q2, Waveform

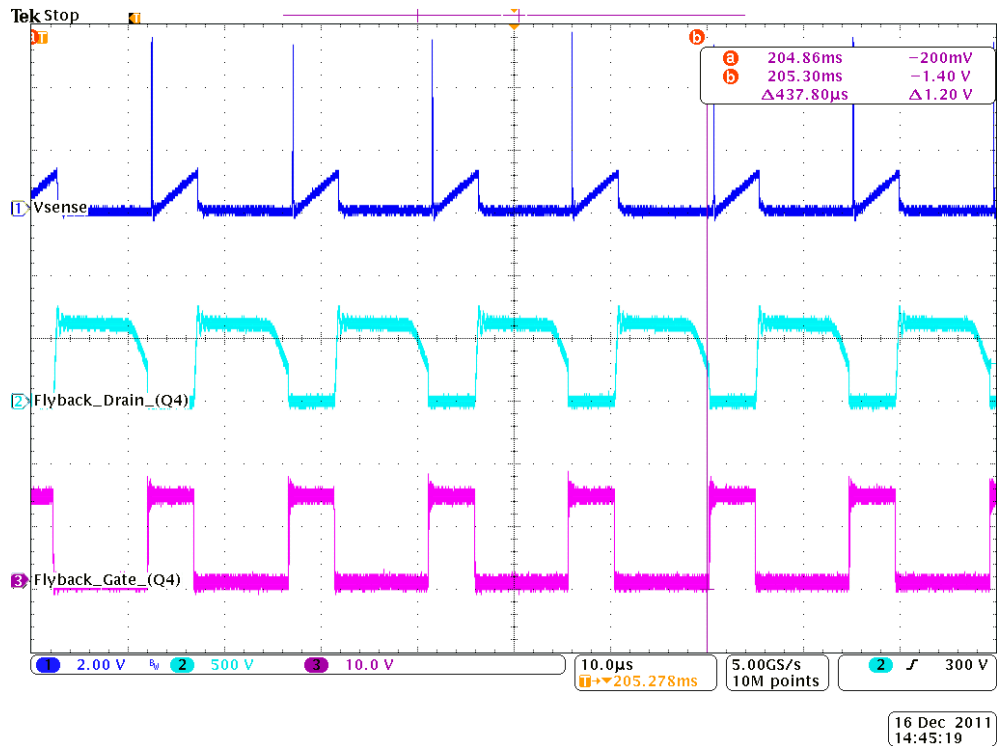


Figure 20. Flyback FET, Q4, Waveform

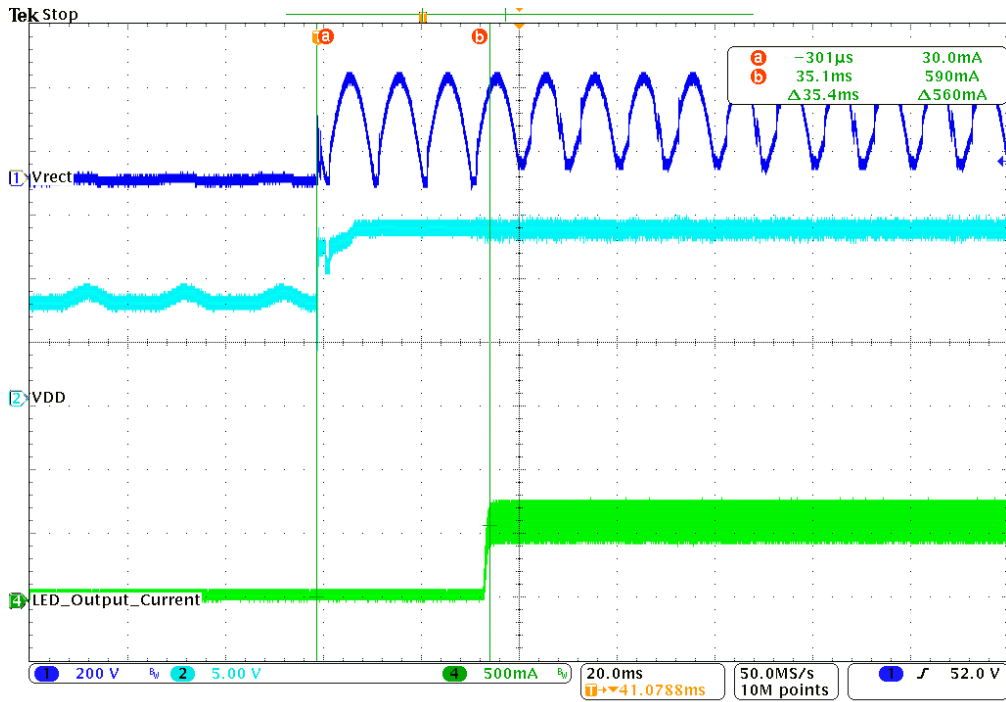

 16 Dec 2011
 13:49:45

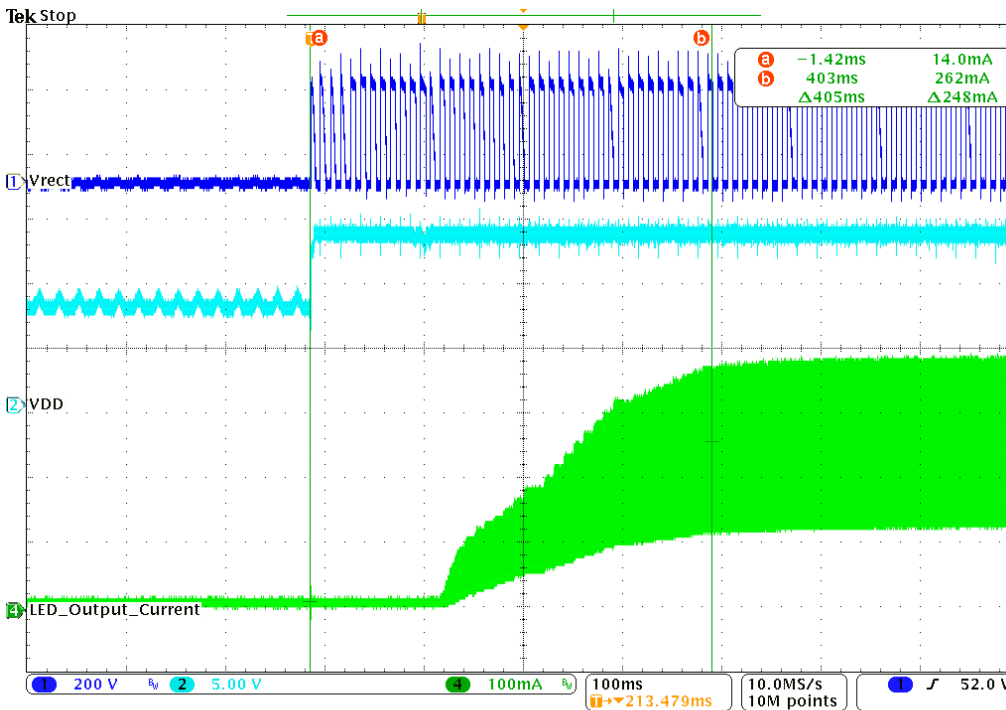
Figure 21. ILED at Maximum Dim Angle, Turn-on Waveforms

 16 Dec 2011
 13:54:22

Figure 22. ILED at Medium Dim Angle, Turn-on Waveforms

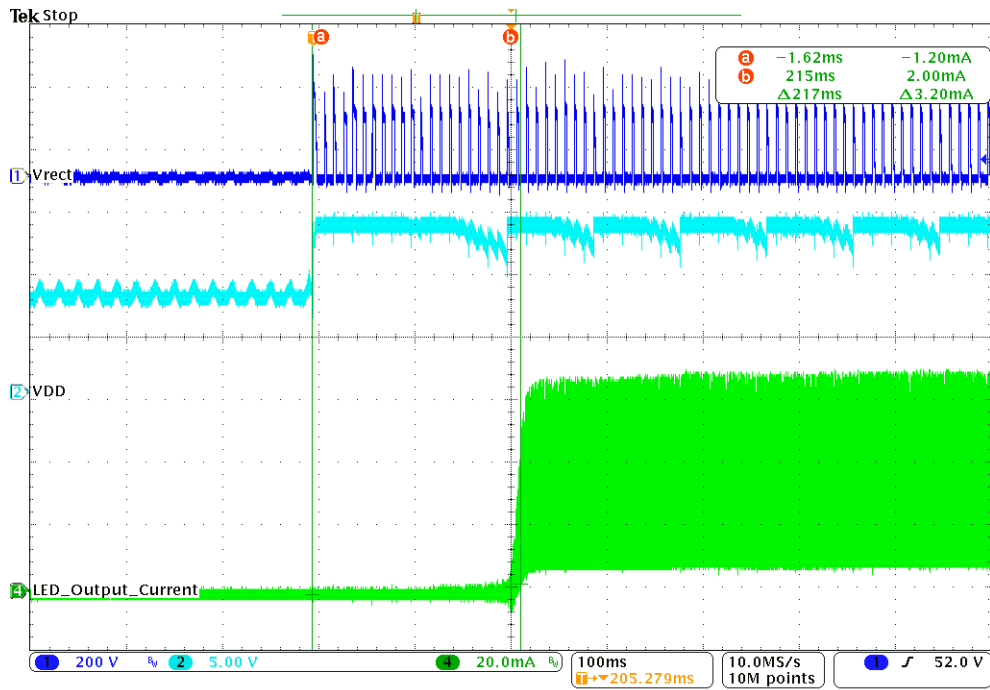


Figure 23. ILED at Minimum Dim Angle, Turn-on Waveforms

9. CONDUCTED EMI
Device Under Test: CRD1611-8W-Z

Operating Conditions: NOMNIAL

Test Specification: IEC 61000-3-2

Operator Name: JDW & JCM

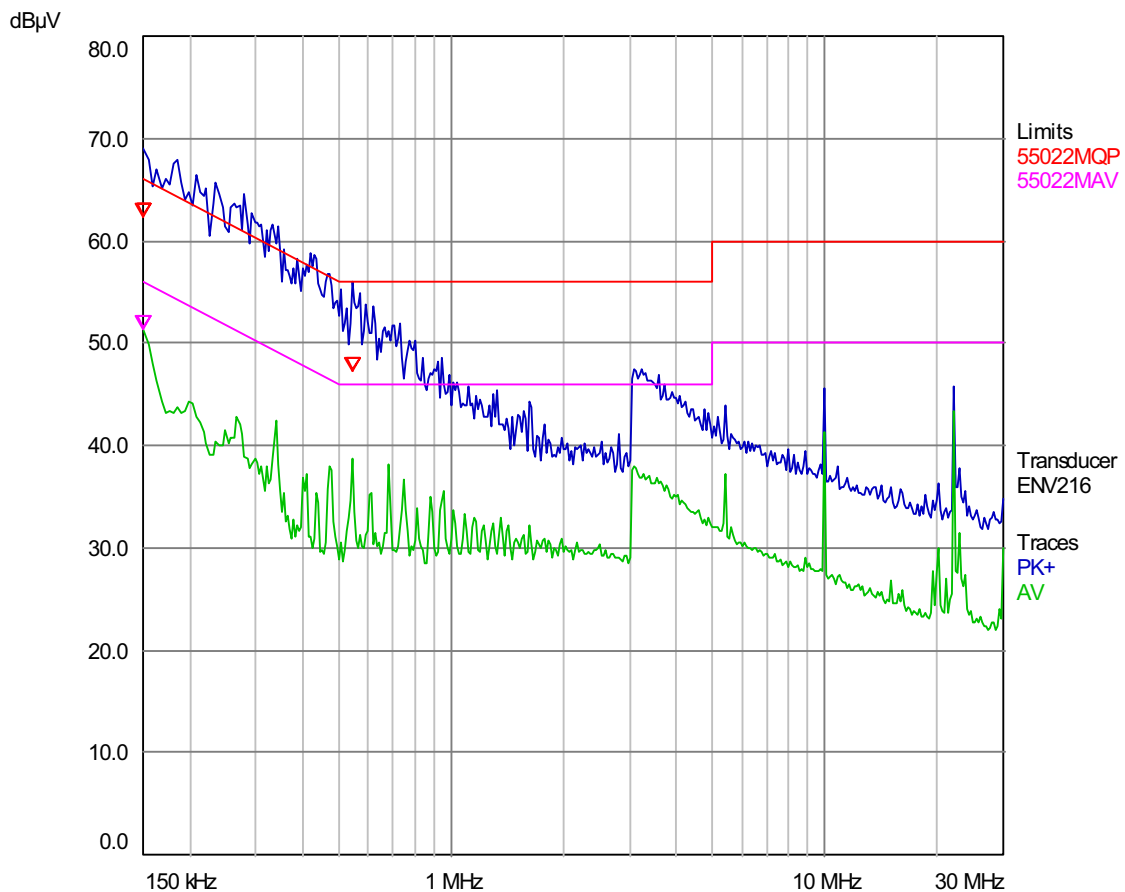
Scan Settings (1 Range)

Frequencies			Receiver Settings			
Start	Stop	Step	Res BW	M-Time	Atten	Preamp
150kHz	30MHz	4.5kHz	9kHz (6dB)	10ms	Auto	Off

Final Measurement
Detectors: QP, AV

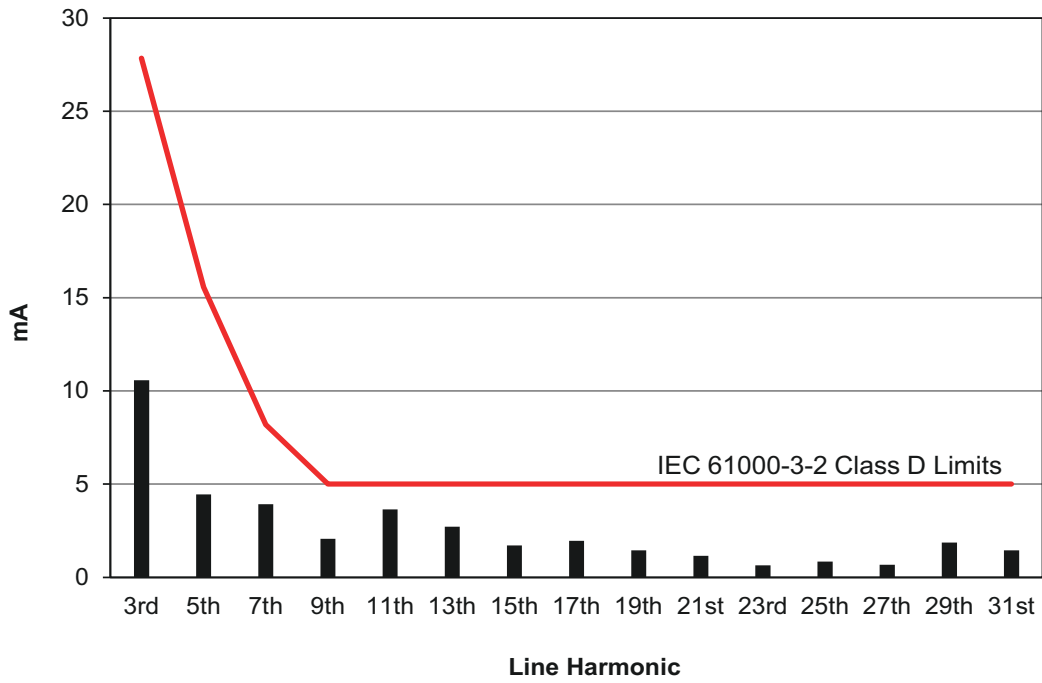
Peaks: 25

Meas Time: 1s

Acc. Margin: 6dB

Figure 24. Conducted EMI
Final Measurement Results

Trace	Frequency (MHz)	Level (dBµV)	Limit (dBµV)	Delta Limit (dB)	Delta Ref (dB)	Comment
1QP	0.15	62.42	66.00	-3.58		N/on
2AV	0.15	51.27	56.00	-4.73		N/on
1QP	0.546	47.18	56.00	-8.82		N/on

* = Limit Exceeded

10. HARMONIC CONTENT

Figure 25. Harmonic Content

11. REVISION HISTORY

Revision	Date	Changes
RD1	DEC 2011	Initial release
RD2	JAN 2012	Content change to BOM, schematic, and bottom silkscreen
RD3	FEB 2012	Content change to features
RD4	MAY 2012	Corrected a typographical error
RD5	FEB 2013	Corrected typographical errors