

CRD1610-8W

8 Watt Reference Design

Features

- Quasi-resonant Flyback with Constant-current Output
- Flicker-free Dimming
- Line Voltage 120VAC, $\pm 10\%$
- Rated Input Power: 8.1W
- Rated Output Power: 6.7W
- Output Voltage: 14.0V to 15.8V
- Efficiency: 84% at 460mA, for 5×LEDs in Series
- Low Component Count
- Supports Cirrus Logic Product CS1610

General Description

The CRD1610-8W reference design demonstrates the performance of the CS1610 resonant mode AC/DC dimmable LED driver IC with a 460mA output driving 5×LEDs in series. It offers best-in-class dimmer compatibility with leading-edge, trailing-edge, and digital dimmers. The form factor is targeted to fit into many LED bulb applications (A19, PAR).

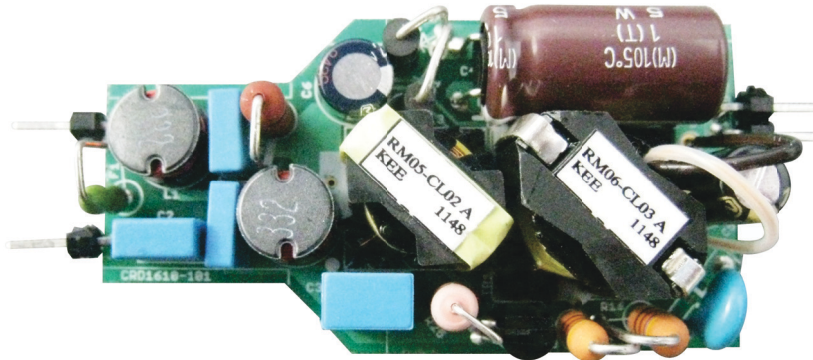
DIMENSIONS (OVERALL)

Length	Width	Height
2.284" (58mm)	× 1.181" (29.9mm)	× 0.59" (15mm)

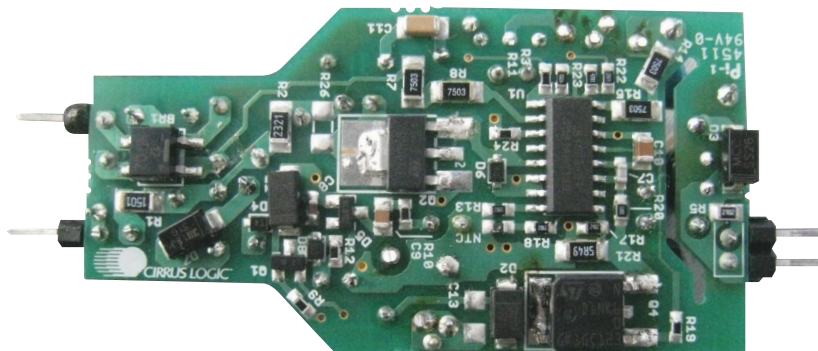
For more information, see Figure 3.

ORDERING INFORMATION

CRD1610-8W-Z 8 Watt Reference Design
Supports CS1610



Top



Bottom



IMPORTANT SAFETY INSTRUCTIONS

Read and follow all safety instructions prior to using this demonstration board.

This Engineering Evaluation Unit or Demonstration Board must only be used for assessing IC performance in a laboratory setting. This product is not intended for any other use or incorporation into products for sale.

This product must only be used by qualified technicians or professionals who are trained in the safety procedures associated with the use of demonstration boards.

⚠ DANGER Risk of Electric Shock

- The direct connection to the AC power line and the open and unprotected boards present a serious risk of electric shock and can cause serious injury or death. Extreme caution needs to be exercised while handling this board.
- Avoid contact with the exposed conductor or terminals of components on the board. High voltage is present on exposed conductor and it may be present on terminals of any components directly or indirectly connected to the AC line.
- Dangerous voltages and/or currents may be internally generated and accessible at various points across the board.
- Charged capacitors store high voltage, even after the circuit has been disconnected from the AC line.
- Make sure that the power source is off before wiring any connection. Make sure that all connectors are well connected before the power source is on.
- Follow all laboratory safety procedures established by your employer and relevant safety regulations and guidelines, such as the ones listed under, OSHA General Industry Regulations - Subpart S and NFPA 70E.

⚠ WARNING Suitable eye protection must be worn when working with or around demonstration boards. Always comply with your employer's policies regarding the use of personal protective equipment.

⚠ WARNING All components and metallic parts may be extremely hot to touch when electrically active.

Contacting Cirrus Logic Support

For all product questions and inquiries contact a Cirrus Logic Sales Representative. To find the one nearest to you go to www.cirrus.com

IMPORTANT NOTICE

Cirrus Logic, Inc. and its subsidiaries ("Cirrus") believe that the information contained in this document is accurate and reliable. However, the information is subject to change without notice and is provided "AS IS" without warranty of any kind (express or implied). Customers are advised to obtain the latest version of relevant information to verify, before placing orders, that information being relied on is current and complete. All products are sold subject to the terms and conditions of sale supplied at the time of order acknowledgment, including those pertaining to warranty, indemnification, and limitation of liability. No responsibility is assumed by Cirrus for the use of this information, including use of this information as the basis for manufacture or sale of any items, or for infringement of patents or other rights of third parties. This document is the property of Cirrus and by furnishing this information, Cirrus grants no license, express or implied under any patents, mask work rights, copyrights, trademarks, trade secrets or other intellectual property rights. Cirrus owns the copyrights associated with the information contained herein and gives consent for copies to be made of the information only for use within your organization with respect to Cirrus integrated circuits or other products of Cirrus. This consent does not extend to other copying such as copying for general distribution, advertising or promotional purposes, or for creating any work for resale.

CERTAIN APPLICATIONS USING SEMICONDUCTOR PRODUCTS MAY INVOLVE POTENTIAL RISKS OF DEATH, PERSONAL INJURY, OR SEVERE PROPERTY OR ENVIRONMENTAL DAMAGE ("CRITICAL APPLICATIONS"). CIRRUS PRODUCTS ARE NOT DESIGNED, AUTHORIZED OR WARRANTED FOR USE IN PRODUCTS SURGICALLY IMPLANTED INTO THE BODY, AUTOMOTIVE SAFETY OR SECURITY DEVICES, LIFE SUPPORT PRODUCTS OR OTHER CRITICAL APPLICATIONS. INCLUSION OF CIRRUS PRODUCTS IN SUCH APPLICATIONS IS UNDERSTOOD TO BE FULLY AT THE CUSTOMER'S RISK AND CIRRUS DISCLAIMS AND MAKES NO WARRANTY, EXPRESS, STATUTORY OR IMPLIED, INCLUDING THE IMPLIED WARRANTIES OF MERCHANTABILITY AND FITNESS FOR PARTICULAR PURPOSE, WITH REGARD TO ANY CIRRUS PRODUCT THAT IS USED IN SUCH A MANNER. IF THE CUSTOMER OR CUSTOMER'S CUSTOMER USES OR PERMITS THE USE OF CIRRUS PRODUCTS IN CRITICAL APPLICATIONS, CUSTOMER AGREES, BY SUCH USE, TO FULLY INDEMNIFY CIRRUS, ITS OFFICERS, DIRECTORS, EMPLOYEES, DISTRIBUTORS AND OTHER AGENTS FROM ANY AND ALL LIABILITY, INCLUDING ATTORNEYS' FEES AND COSTS, THAT MAY RESULT FROM OR ARISE IN CONNECTION WITH THESE USES.

Cirrus Logic, Cirrus, the Cirrus Logic logo designs, EXL Core, the EXL Core logo design, TruDim, and the TruDim logo design are trademarks of Cirrus Logic, Inc. All other brand and product names in this document may be trademarks or service marks of their respective owners.

1. INTRODUCTION

The CS1610 is a 120VAC quasi-resonant flyback mode dimmable LED controller IC. The CS1610 uses a digital control algorithm that is optimized for high efficiency and ≥ 0.90 power factor over a wide input voltage range (108VAC to 132VAC). The CS1610 integrates a critical conduction mode (CRM) boost converter that provides power factor correction and dimmer compatibility with a constant output current, quasi-resonant flyback stage. An adaptive dimmer compatibility algorithm controls the boost stage and dimmer compatibility operation mode to enable flicker-free operation to $< 2\%$ output current with leading-edge, trailing-edge, and digital dimmers.

The CRD1610-8W board is optimized to deliver low system cost in a high-efficiency, flicker-free, phase-dimmable, solid-state lighting (SSL) solution for incandescent lamp replacement applications. The feedback loop is closed through an integrated digital control system within the IC. The variation in switching frequency also provides a spread-frequency spectrum, thus minimizing the conducted EMI filtering requirements. Protection algorithms such as output open/short, current-sense resistor open/short, and overtemperature thermistors protect the system during abnormal conditions. Details of these features are provided in the CS1610 data sheet.

The CRD1610-8W board demonstrates the performance of the CS1610. This reference board has been designed for an output load of $5 \times$ LEDs in series at 460mA (14.6V typical).

This document provides the schematic for the board. It includes oscilloscope screen shots that indicate various operating waveforms. Graphs are also provided that document the performance of the board in terms of Efficiency vs. Line Voltage, Output Current vs. Line Voltage, and Output Current vs. Dim Angle for the CS1610 dimmable LED controller IC. Extreme caution needs to be exercised while handling this board. This board is to be used by trained professionals only.

2. SCHEMATIC

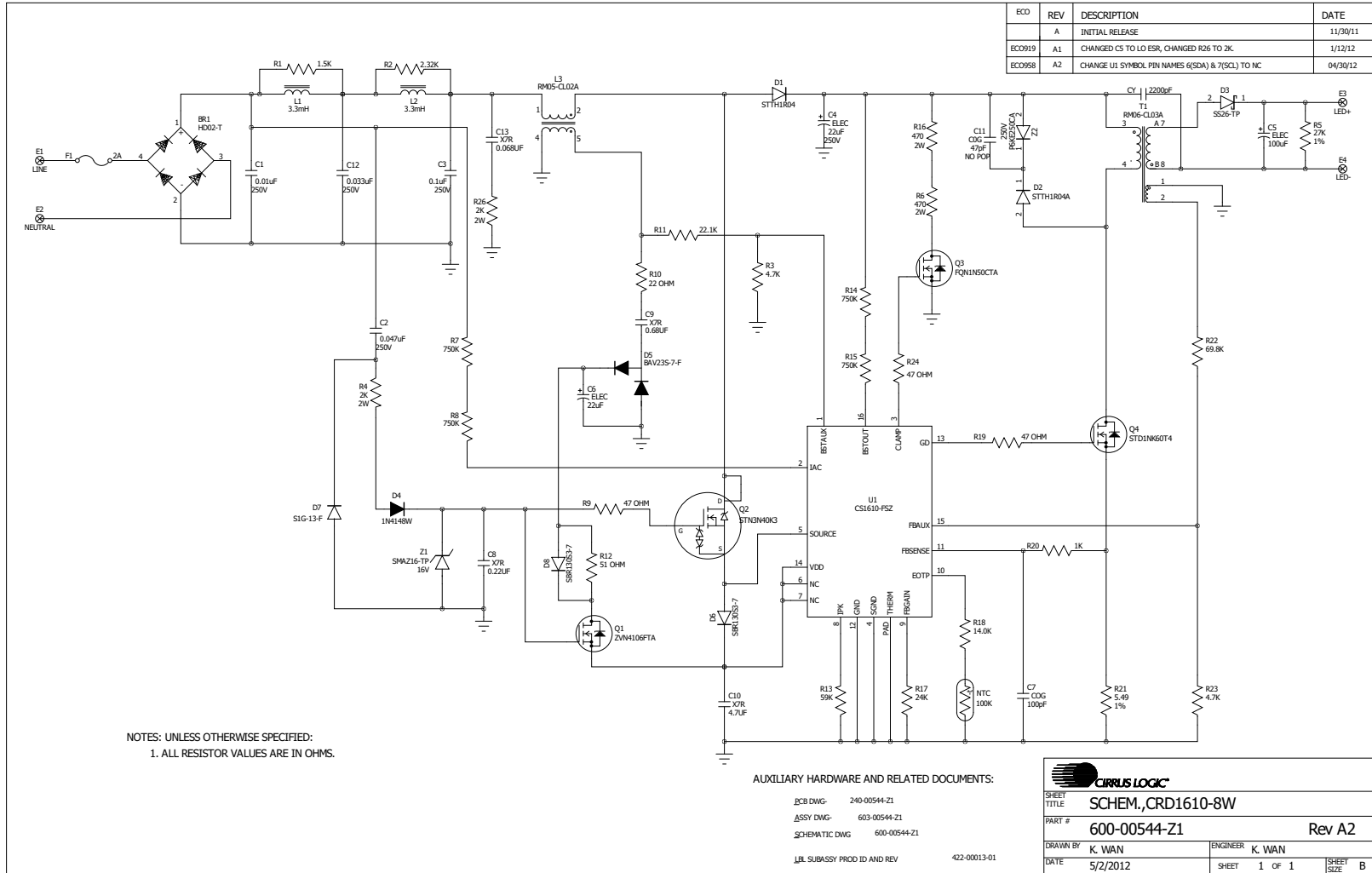


Figure 1. Schematic

3. BILL OF MATERIALS
CIRRUS LOGIC
CRD1610-8W_Rev_A.bom
BILL OF MATERIAL

Item	Rev	Description	Qty	Reference Designator	MFG	MFG P/N
1	A	DIODE RECT 200V 0.8A NPb MINIDIP	1	BR1	DIODES INC	HD02-T
2	A	CAP 0.01uF ±10% 250V POLY NPb RAD	1	C1	EPCOS	B32529C3103K
3	A	CAP 0.047uF ±5% 250V POLY NPb RAD	1	C2	EPCOS	B32529C3473J
4	A	CAP 0.1uF ±10% 250V POLY NPb RAD	1	C3	EPCOS	B32529C3104K
5	A	CAP 22uF ±20% 250V ELEC NPb RAD	1	C4	NICHICON	UVY2E220MPD
6	A	CAP 100uF ±20% 25V EL LO ESR NPb RD	1	C5	PANASONIC	EEUFM1E101
7	A	CAP 22uF ±20% 35V ELEC NPb RAD	1	C6	PANASONIC	EEA-GA1V220H
8	A	CAP 100pF ±5% 50V COG NPb 0603	1	C7	KEMET	C0603C101J5GAC
9	A	CAP 0.22uF ±10% 25V X7R NPb 0603	1	C8	TDK	C1608X7R1E224K
10	A	CAP 0.68uF ±10% 50V X7R NPb 0805	1	C9	KEMET	C0805C684K5RAC
11	A	CAP 4.7uF ±10% 25V X7R NPb 0805	1	C10	TDK	C2012X7R1E475K
12	A	CAP 47pF ±5% 1000V COG NPb 1206	0	C11	JOHANSON DIELECTRICS	102R18N470JV4E
13	A	CAP 0.033uF ±10% 250V POLY NPb RAD	1	C12	EPCOS	B32529C3333K
14	A	CAP 0.068uF ±10% 250V X7R NPb 1206	1	C13	KEMET	C1206C683KARAC
15	A	CAP 2200PF +80/-20% 2KV CER NPb RAD	1	CY	MURATA	DEBE33D222ZA2B
16	A	DIODE FAST 400V 1A NPb DO-41	1	D1	ST MICROELECTRONICS	STTH1R04
17	A	DIODE FAST 400V 1A NPb SMA	1	D2	ST MICROELECTRONICS	STTH1R04A
18	A	DIODE SKY RECT 60V 2A NPb DO-214AC	1	D3	MICRO COMMERCIAL(MCC)	SS26-TP
19	A	DIODE FAST SW 75V 350mW NPb SOD123	1	D4	DIODES INC	1N4148W-7-F
20	A	DIODE SWT 250V 0.4A NPb SOT-23	1	D5	DIODES INC	BAV23S-7-F
21	A	DIODE RECT 30V 1A NPb SOD-323	2	D6 D8	DIODES INC	SBR130S3-7
22	A	DIODE RECT 400V 1A NPb SMA	1	D7	DIODES INC	S1G-13-F
23	A	FUSE 2A 125V VFA NPb AXL	1	F1	LITTELFUSE	0251002.MXL
24	A	IND 3.3mH ±10% 11.8OHM DCR NPb TH	2	L1 L2	COILCRAFT	RFB0807-332L
25	A	XFMR 1.45mH 10% NPb TH	1	L3	KUNSHAN EAGERNESS	RM05-CLO2A
26	A	THERM 100K OHM ±5% 0.10mA NPb 0603	1	NTC	MURATA	NCP18WF104J03R8
27	A	TRAN MOSFET nCH 60V.2A NPb SOT23-3	1	Q1	DIODES INC	ZVN4106FTA
28	A	TRAN MOSFT nCH 1.8A 400V NPb SOT223	1	Q2	ST MICROELECTRONICS	STN3N40K3
29	A	TRAN MOSFET nCH 0.38A 500V NPb TO92	1	Q3	FAIRCHILD	FQN1N50CTA
30	A	TRAN MOSFET nCH 1.0A 600V NPb DPAK	1	Q4	ST MICROELECTRONICS	STD1NK60T4
31	A	RES 1.5k OHM 1/4W ±1% NPb 1206	1	R1	DALE	CRCW12061K50FKFA
32	A	RES 2.32k OHM 1/4W ±1% 1206 FILM	1	R2	DALE	CRCW12062K32FKFA
33	A	RES 4.70k OHM 1/10W ±1% NPb 0603	2	R3 R23	PANASONIC	ERJ3EKF4701V
34	A	RES PWR 2.0K OHM 2W ±5% NPb AXL	1	R4	VISHAY	PRO2000202001JR500
35	A	RES 27K OHM 1/8W ±1% NPb 0805	1	R5	PANASONIC	ERJ6ENF2702V
36	A	RES 470 OHM 2W ±5% MTL FLM NPb AXL	2	R6 R16	VISHAY	PRO2000204700JR500
37	A	RES 750k OHM 1/4W ±1% NPb 1206 FILM	4	R7 R8 R14 R15	DALE	CRCW1206750KFKEA
38	A	RES 47 OHM 1/10W ±1% NPb 0603	3	R9 R19 R24	PANASONIC	ERJ3EKF47R0V
39	A	RES 22.0 OHM 1/10W ±1% NPb 0603	1	R10	PANASONIC	ERJ3EKF22R0V
40	A	RES 22.1k OHM 1/10W ±1% NPb 0603	1	R11	DALE	CRCW060322K1FKFA
41	A	RES 51.0 OHM 1/10W ±1% NPb 0603	1	R12	PANASONIC	ERJ3EKF51R0V
42	A	RES 59k OHM 1/10W ±1% NPb 0603 FILM	1	R13	DALE	CRCW060359K0FKFA
43	A	RES 24k OHM 1/10W ±1% NPb 0603 FILM	1	R17	DALE	CRCW060324K0FKFA
44	A	RES 14k OHM 1/10W ±1% NPb 0603 FILM	1	R18	DALE	CRCW060314K0FKFA
45	A	RES 1k OHM 1/10W ±1% NPb 0603 FILM	1	R20	DALE	CRCW06031K00FKFA
46	A	RES 5.49 OHM 1/4W ±1% NPb 1206 FLM	1	R21	DALE	CRCW12065R49FKFA
47	A	RES 69.8k OHM 1/10W ±1% NPb 0603	1	R22	DALE	CRCW060369K8FKFA
48	A	RES PWR 2.0K OHM 2W ±5% NPb AXL	1	R26	VISHAY	PRO2000202001JR500
49	A	XFMR 3.1mH 10% NPb TH	1	T1	KUNSHAN EAGERNESS	RM06-CLO3A
50	B1	IC CRUS DIMMER LED DRVR NPb SOIC16	1	U1	Cirrus Logic	CS1610-FSZ/B1
51	A	DIODE ZENER 16V 1W NPb DO-214AC	1	Z1	MICRO COMMERCIAL	SMAZ16-TP
52	A	DIODE TVS 250V 600W BID NPb AXL	1	Z2	ST MICROELECTRONICS	P6KE250CA

Figure 2. Bill of Materials

4. BOARD LAYOUT

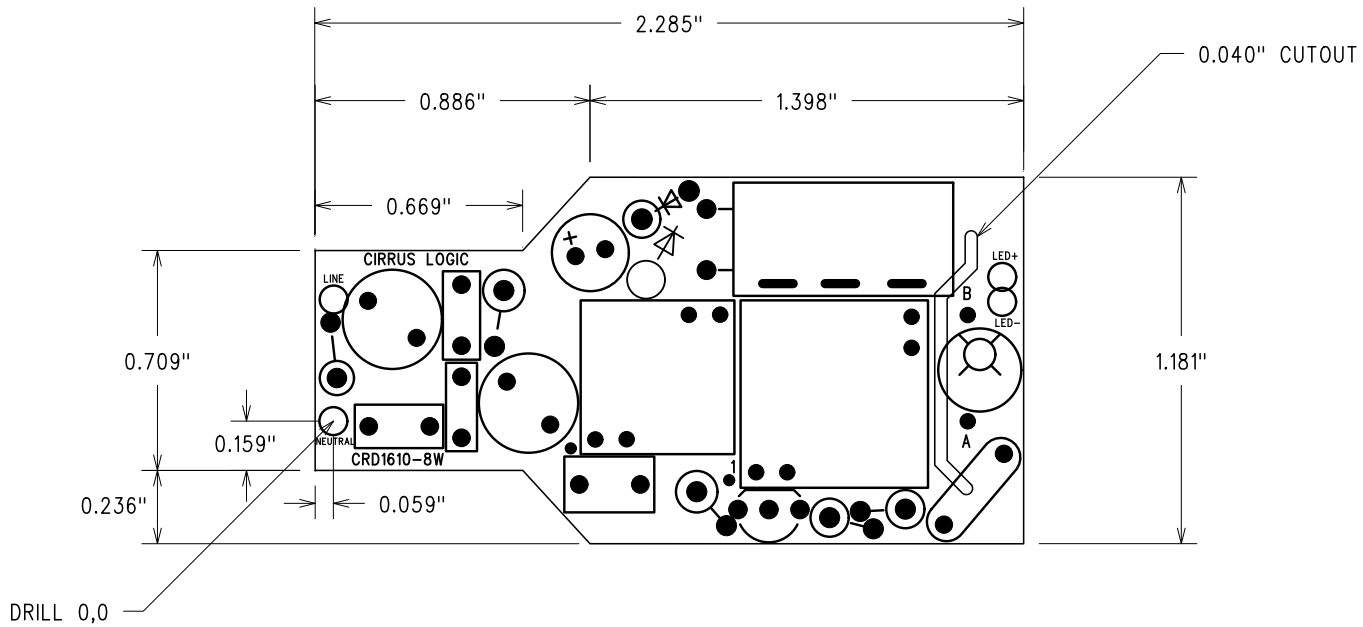


Figure 3. PCB Dimensions

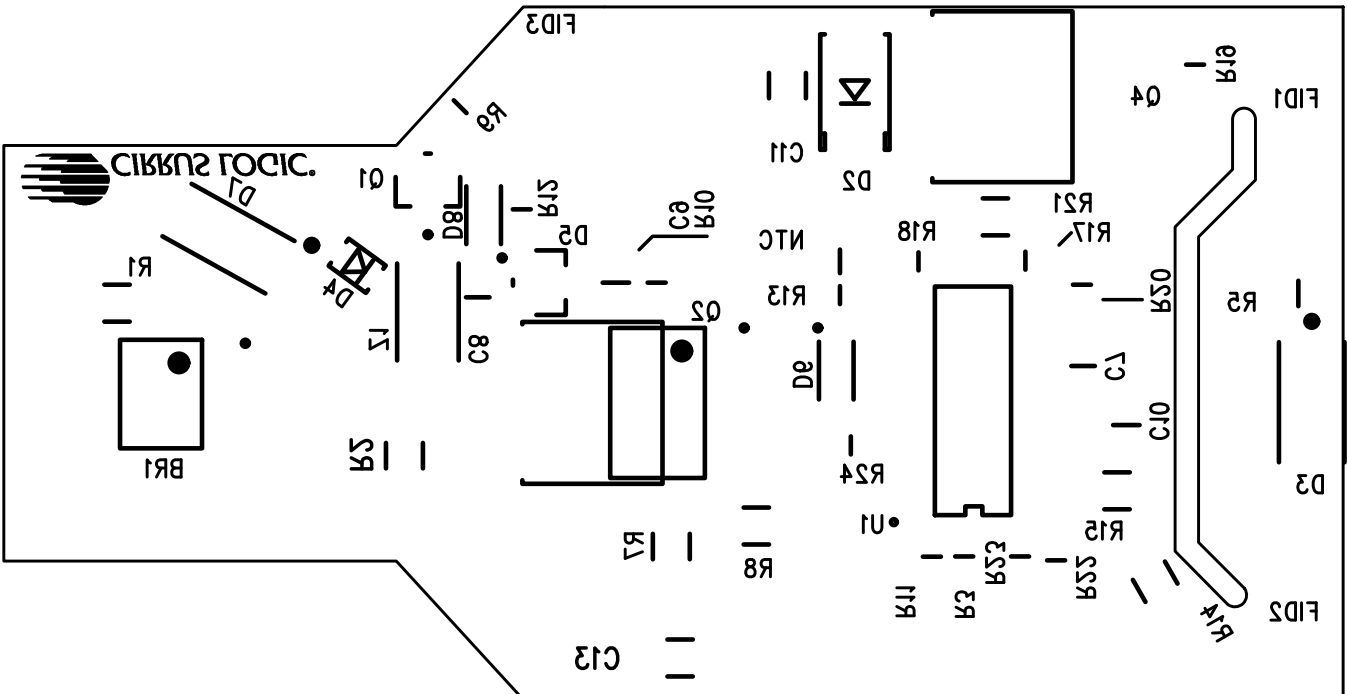


Figure 5. Bottom Silkscreen

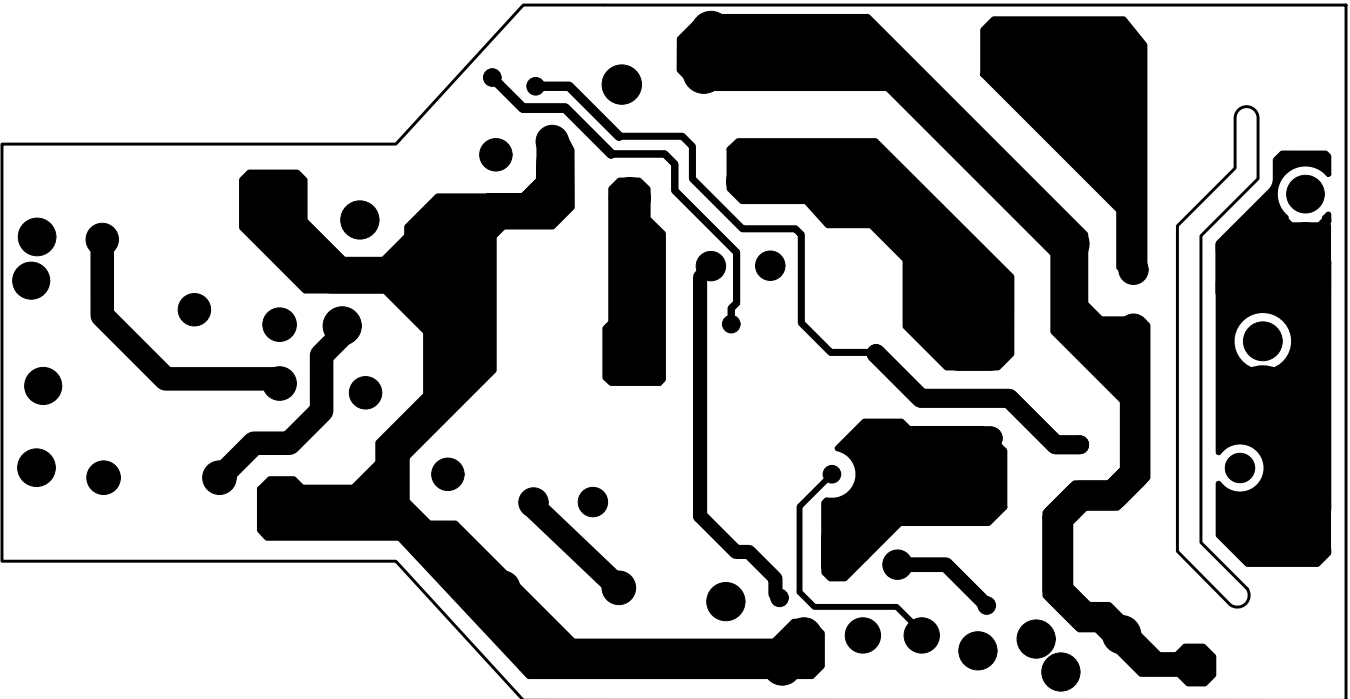


Figure 6. Top Routing

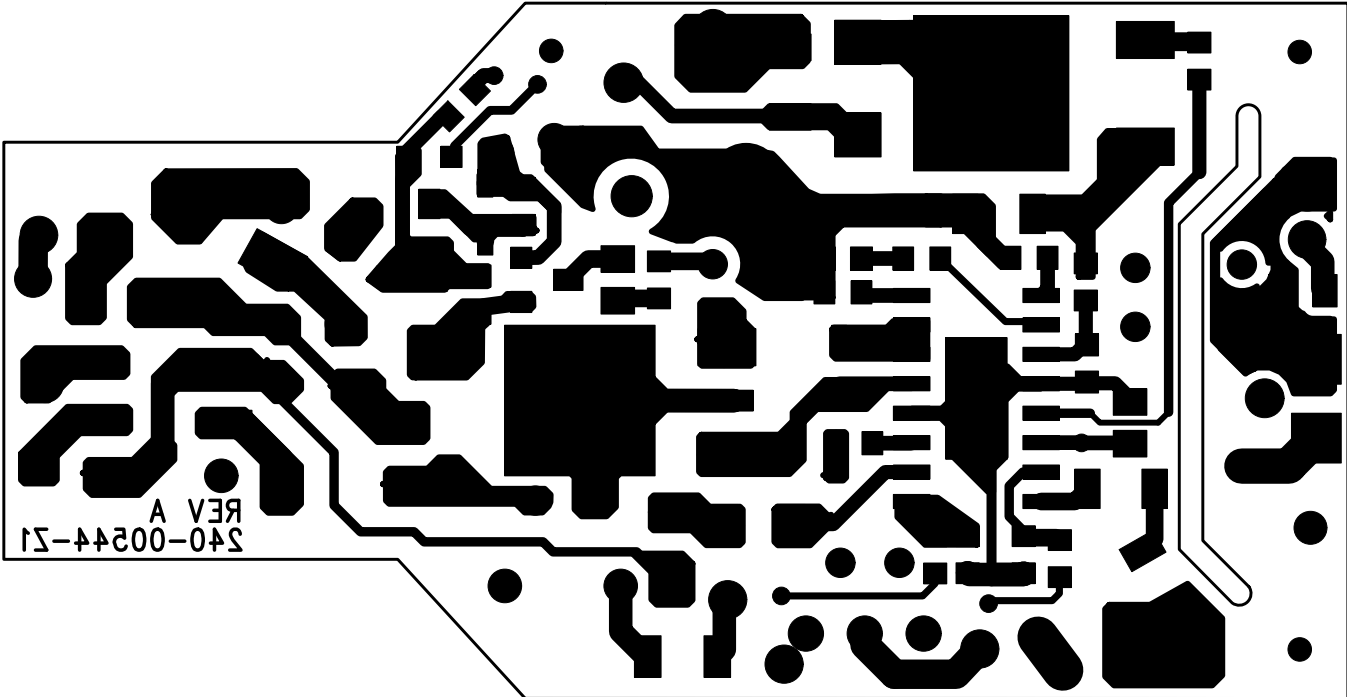


Figure 7. Bottom Routing

5. THERMAL IMAGING

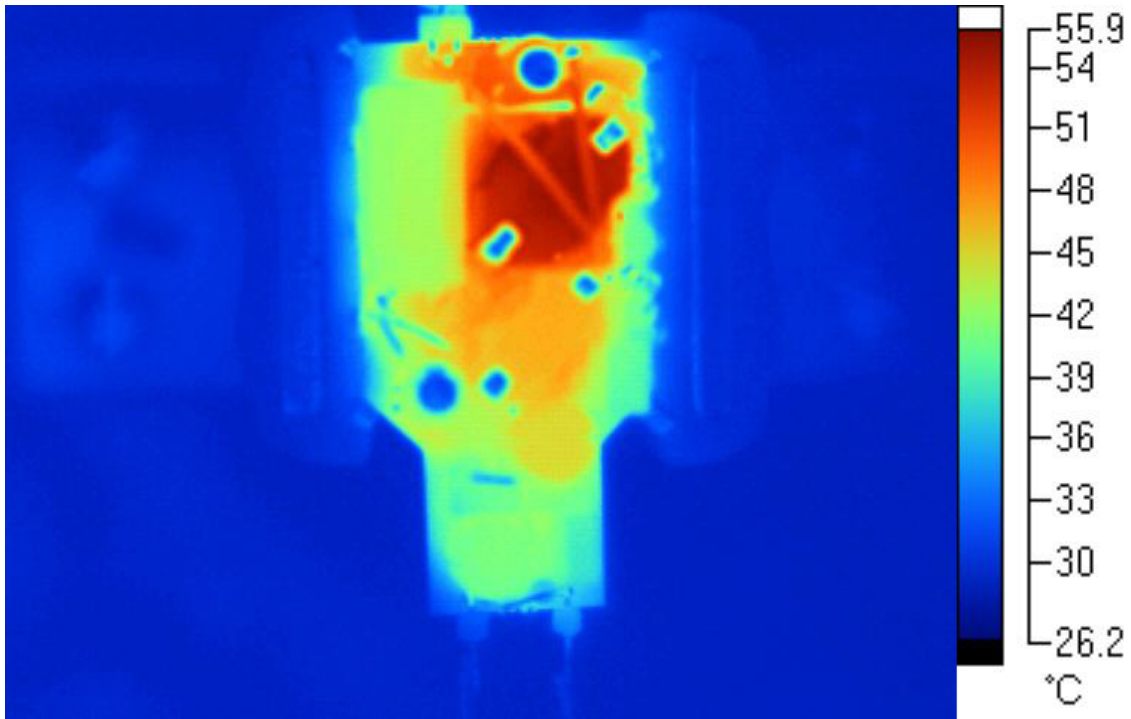


Figure 8. Top Thermal

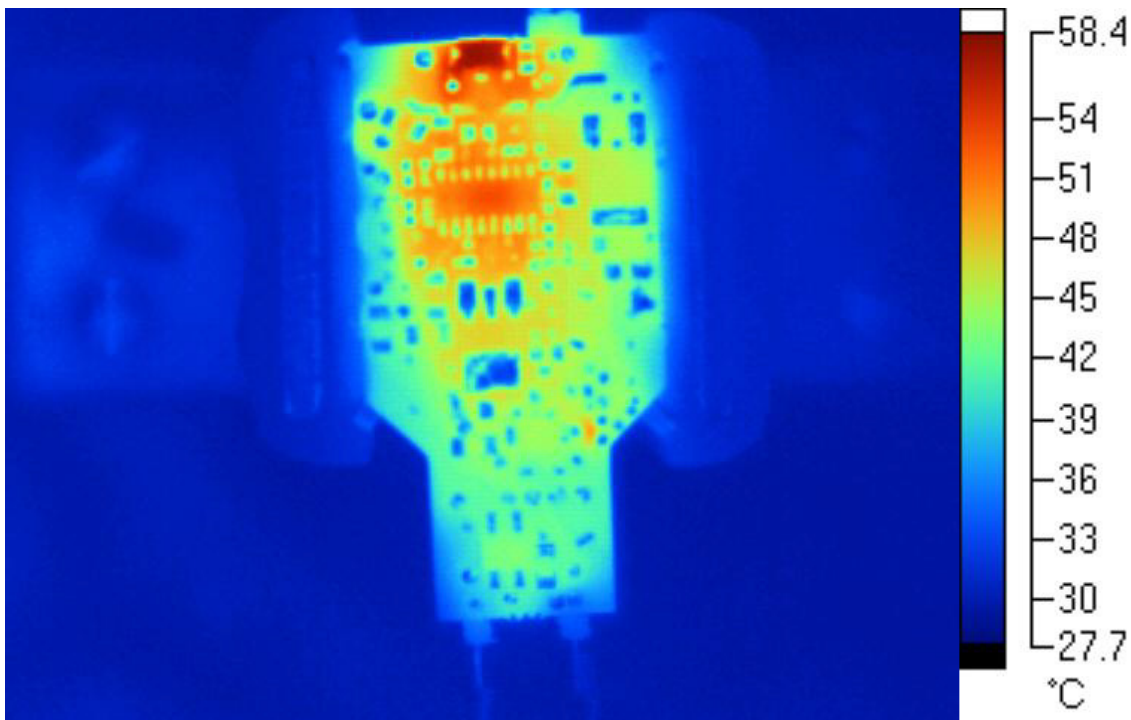


Figure 9. Bottom Thermal

6. DIMMER COMPATIBILITY - PAR 16 WITH CS1610 (108V - 132V)

Input Power	8.3W	Dimmer Compatibility	836/888	Efficiency	84.3%
-------------	-------------	----------------------	----------------	------------	--------------

Date	12/19/2011	Power Factor ^{1,5}	0.91
Vendor	Cirrus Logic	EN55015 Compliant (Y/N)	Y
Input Voltage	120V	Nominal Input Power (W) ^{1,5}	8.3
Form Factor	PAR 16	Maximum Input Power (W) ^{2,5}	8.5
Model #	CRD1610-8W	Output Voltage (V) ^{1,3}	14.8
IC	CS1610	Output Current (mA) ^{1,3}	470
Topology	Boost/Flyback	Output Current Ripple ≤ 120Hz (mA) ^{1,4}	0
Isolation (Y/N)	Y	Output Power (W) ^{1,5}	7.0
Compatibility Spec.	1.0	Efficiency (%)	84.3

Dimmer Type	Flicker Free Steady-state			Monotonic Dimming			Max I _{out} (mA)			Min I _{out} (mA)			Total
	# of Lamps			# of Lamps			# of Lamps			# of Lamps			
	1	5	10	1	5	10	1	5	10	1	5	10	
Cooper - Leading Edge	Y	Y	Y	Y	Y	Y	470	470	469	14	14	22	23
Cooper - Leading Edge	Y	Y	Y	Y	Y	Y	470	470	470	9	9	9	24
GE - Leading Edge	Y	Y	Y	Y	Y	Y	470	469	470	9	9	9	24
Leviton - Leading Edge	Y	Y	N	Y	Y	Y	469	469	470	10	11	11	19
Leviton - Leading Edge	Y	Y	Y	Y	Y	Y	469	468	469	9	9	9	24
Leviton - Trailing Edge	Y	Y	Y	Y	Y	Y	469	469	469	11	10	9	24
Leviton - Trailing Edge	Y	Y	N	Y	Y	Y	469	469	470	63	60	56	16
Leviton - Leading Edge	Y	Y	Y	Y	Y	Y	469	469	469	9	9	9	24
Leviton - Leading Edge	Y	Y	N	Y	Y	Y	469	469	469	9	9	9	19
Leviton - Leading Edge	Y	Y	Y	Y	Y	Y	470	469	471	9	9	9	24
Leviton - Leading Edge	Y	Y	Y	Y	Y	Y	470	469	470	9	9	9	24
Leviton - Trailing Edge	Y	Y	Y	Y	Y	Y	469	469	470	9	9	9	24
Leviton - Leading Edge	Y	Y	Y	Y	Y	Y	469	470	469	9	9	9	24
Leviton - Leading Edge	Y	Y	Y	Y	Y	Y	469	469	469	56	54	51	21
Leviton - Leading Edge	Y	Y	Y	Y	Y	Y	470	470	469	9	9	9	24
Leviton - Leading Edge	Y	Y	Y	Y	Y	Y	470	469	470	12	13	11	24
Leviton - Occupancy Sensor	Y	Y	Y	Y	Y	Y	470	470	470	0	0	0	24
Leviton - Leading Edge	Y	Y	Y	Y	Y	Y	470	469	470	9	9	9	24
Lutron - Leading Edge	Y	Y	Y	Y	Y	Y	469	470	469	9	9	9	24
Lutron - Leading Edge	Y	Y	Y	Y	Y	Y	470	469	470	9	9	9	24
Lutron - Leading Edge	Y	Y	Y	Y	Y	Y	470	470	469	14	13	11	24

Dimmer Type	Flicker Free Steady-state			Monotonic Dimming			Max I _{out} (mA)			Min I _{out} (mA)			Total
	# of Lamps			# of Lamps			# of Lamps			# of Lamps			
	1	5	10	1	5	10	1	5	10	1	5	10	
Lutron - Trailing Edge	Y	Y	Y	Y	Y	Y	445	440	435	9	9	9	21
Lutron - Leading Edge	Y	Y	Y	Y	Y	Y	470	469	470	9	9	9	24
Lutron - Leading Edge	Y	Y	Y	Y	Y	Y	469	470	469	9	9	9	24
Lutron - Motion Sensor	Y	Y	Y	Y	Y	Y	470	469	470	0	0	0	24
Lutron - Leading Edge	Y	Y	Y	Y	Y	Y	470	470	470	9	9	9	24
Lutron - Leading Edge	Y	Y	Y	Y	Y	Y	433	427	421	9	9	9	21
Lutron - Leading Edge	Y	Y	Y	Y	Y	Y	470	469	470	9	9	9	24
Lutron - Leading Edge	Y	Y	Y	Y	Y	Y	469	469	469	9	9	9	24
Lutron - Leading Edge	Y	Y	Y	Y	Y	Y	469	469	470	9	9	9	24
Lutron - Trailing Edge	Y	Y	Y	Y	Y	Y	440	435	433	9	9	9	21
Lutron - Leading Edge	Y	Y	Y	Y	Y	Y	469	469	470	9	9	9	24
Lutron - Leading Edge	Y	Y	Y	Y	Y	Y	470	470	469	9	9	9	24
Lutron - Leading Edge	Y	Y	N	Y	N	N	469	470	0	9	9	0	16
Lutron - Leading Edge	Y	N	N	Y	Y	N	469	470	0	9	9	0	12
Lutron - Leading Edge	Y	Y	Y	Y	Y	Y	469	469	470	15	12	11	23
Pass & Seymour - Occupancy Sensor	Y	Y	Y	Y	Y	Y	469	469	470	0	0	0	24
Overall Total												836	

- Notes:
1. Tested at nominal input voltage, nominal input frequency and without a dimmer after soaking for 15 minutes
 2. Tested at nominal input voltage, nominal input frequency and with a dimmer after soaking for 15 minutes
 3. Average
 4. Peak-to-peak
 5. Measured with Chroma 66202 Power Analyzer

7. INDUCTOR CONSTRUCTION

The CRD1610-8W includes a critical conduction mode (CRM) boost converter that provides power factor correction and dimmer compatibility with a constant output current, quasi-resonant flyback stage. The following sections describe the boost and flyback inductors installed on the CRD1610-8W.

7.1 Boost Inductor

The CS1610 uses an adaptive dimmer compatibility algorithm to control the boost inductor stage, which guarantees dimmer compatibility operation plus enables flicker-free operation with leading-edge, trailing-edge, and digital dimmers. The boost auxiliary winding is used for zero-current detection (ZCD) and supplies power to the CS1610.

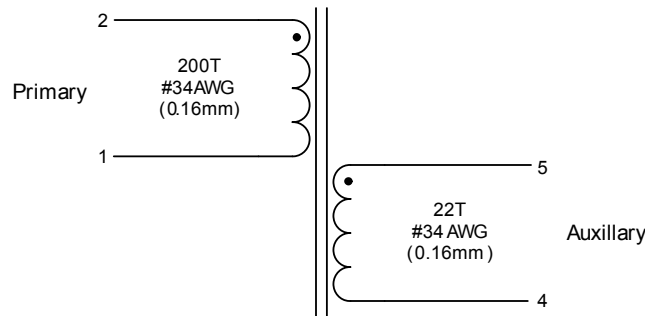


Figure 10. Boost Inductor Schematic

7.1.1 Electrical Specifications

Characteristics conditions:

- Operating temperature range: -25 °C to +120 °C (including coil heat)

Parameter	Condition	Symbol	Min	Typ	Max	Unit
Boost Inductor						
Primary Inductance (Note 6)	$f_{\text{resonant}} = 10\text{kHz}$, 0.3V at 20°C	L_p	1.305	1.45	1.595	mH
Primary DC Resistance (Note 6)	$t_{\text{DCR}} = 20^\circ\text{C}$		3.28	4.1	4.92	Ω
Auxiliary DC Resistance (Note 7)	$t_{\text{DCR}} = 20^\circ\text{C}$		0.456	0.57	0.684	Ω

Notes: 6. Measured across pins 1 and 2.
7. Measured across pins 5 and 4.

7.2 Flyback Transformer

The flyback transformer stage is a quasi-resonant current-regulated DC-DC Converter capable of delivering the highest possible efficiency at a constant current while minimizing line frequency ripple. The auxiliary winding is used for zero-current detection and overvoltage protection.

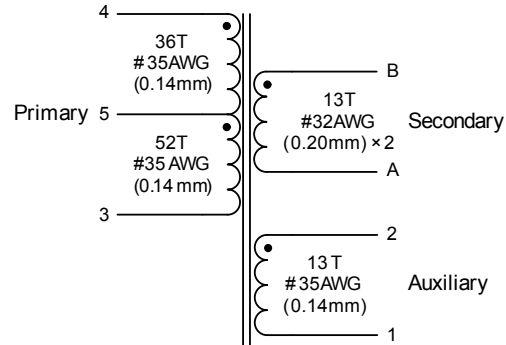


Figure 11. Flyback Transformer Schematic

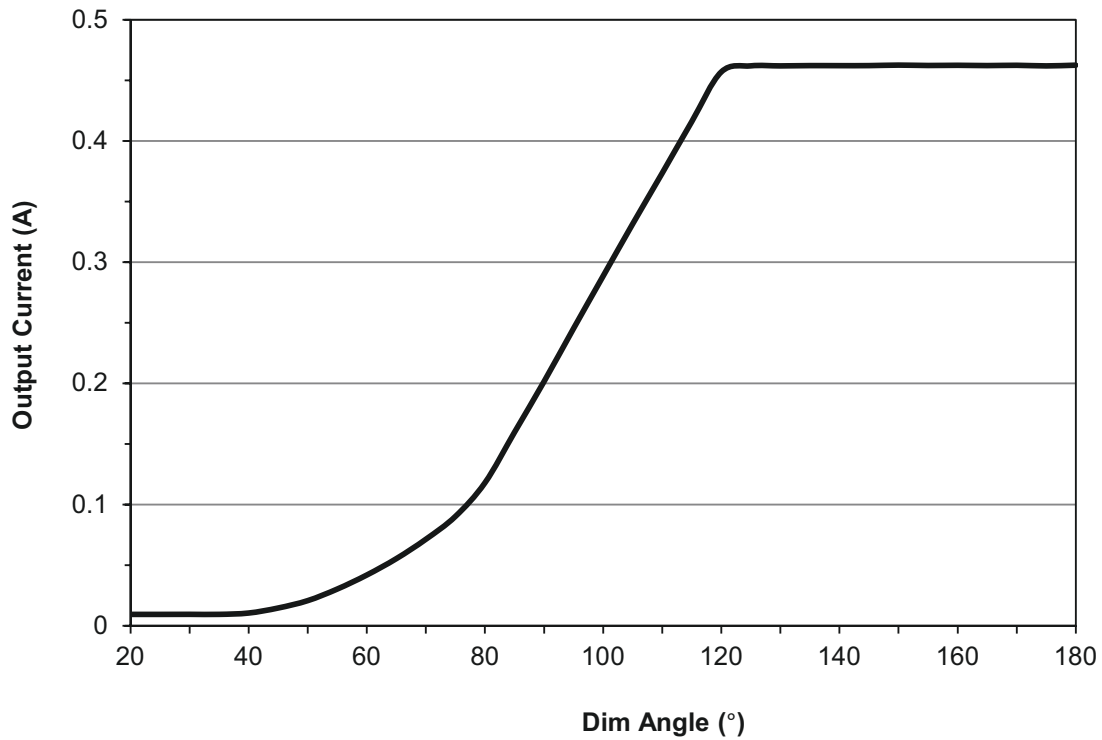
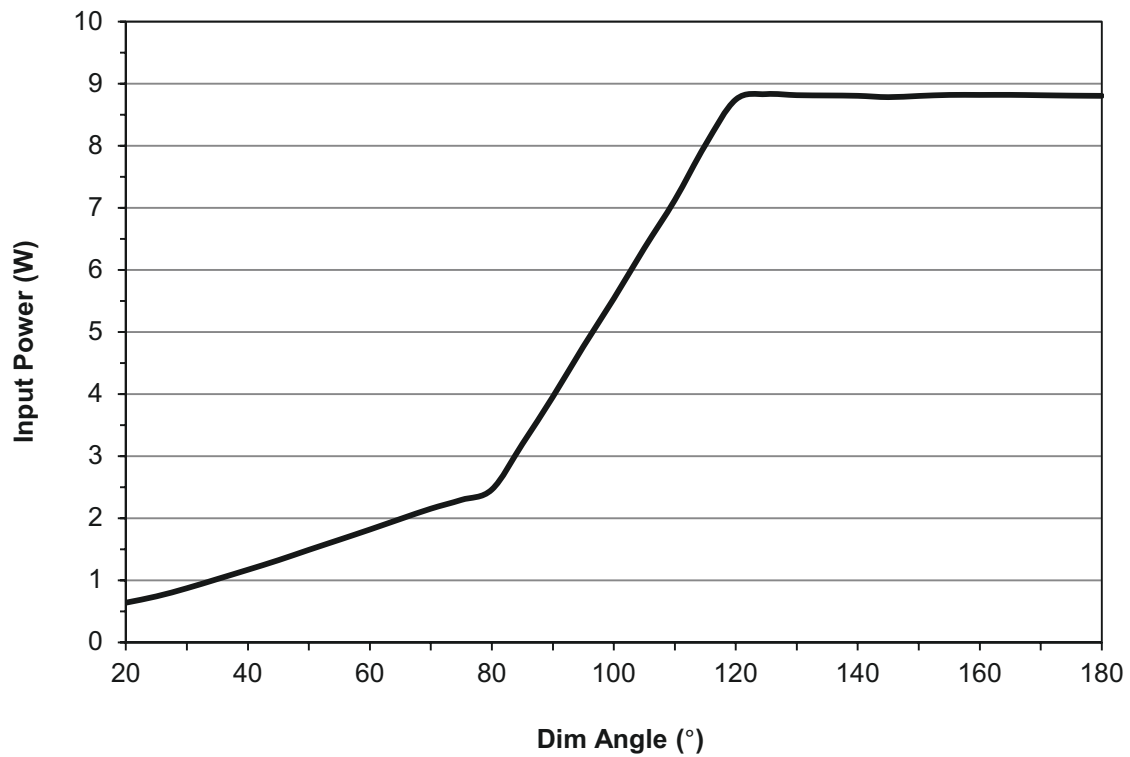
7.2.1 Electrical Specifications

Characteristics conditions:

- Operating temperature range: -25 °C to +120 °C (including coil heat)

Parameter	Condition	Sym	Min	Typ	Max	Unit
Flyback Transformer						
Electrical Strength	(Note 8) $f_{\text{operate}}=50/60\text{Hz}$		-	4K	-	V_{RMS}
Primary Inductance	(Note 9) $f_{\text{resonant}}=10\text{kHz}, 0.3\text{V at } 20^{\circ}\text{C}$	L_{P}	2.79	3.1	3.41	mH
Primary Leakage Inductance	(Note 9) $f_{\text{resonant}}=10\text{kHz}, 0.3\text{V at } 20^{\circ}\text{C}$	L_{K}	-	-	15	μH
Primary DC Resistance	(Note 9) $t_{\text{DCR}}=20^{\circ}\text{C}$		2.175	2.90	3.625	Ω
Secondary DC Resistance	(Note 10) $t_{\text{DCR}}=20^{\circ}\text{C}$		-	-	0.22	Ω
Auxiliary DC Resistance	(Note 11) $t_{\text{DCR}}=20^{\circ}\text{C}$		0.3975	0.53	0.6625	Ω

- Notes:
8. Time = 2sec.
 9. Measured across pins 3 and 4.
 10. Measured across pins B and A.
 11. Measured across pins 2 and 1.

8. PERFORMANCE PLOTS

Figure 12. Typical Output Current vs. Dim Angle

Figure 13. Typical Input Power vs. Dim Angle

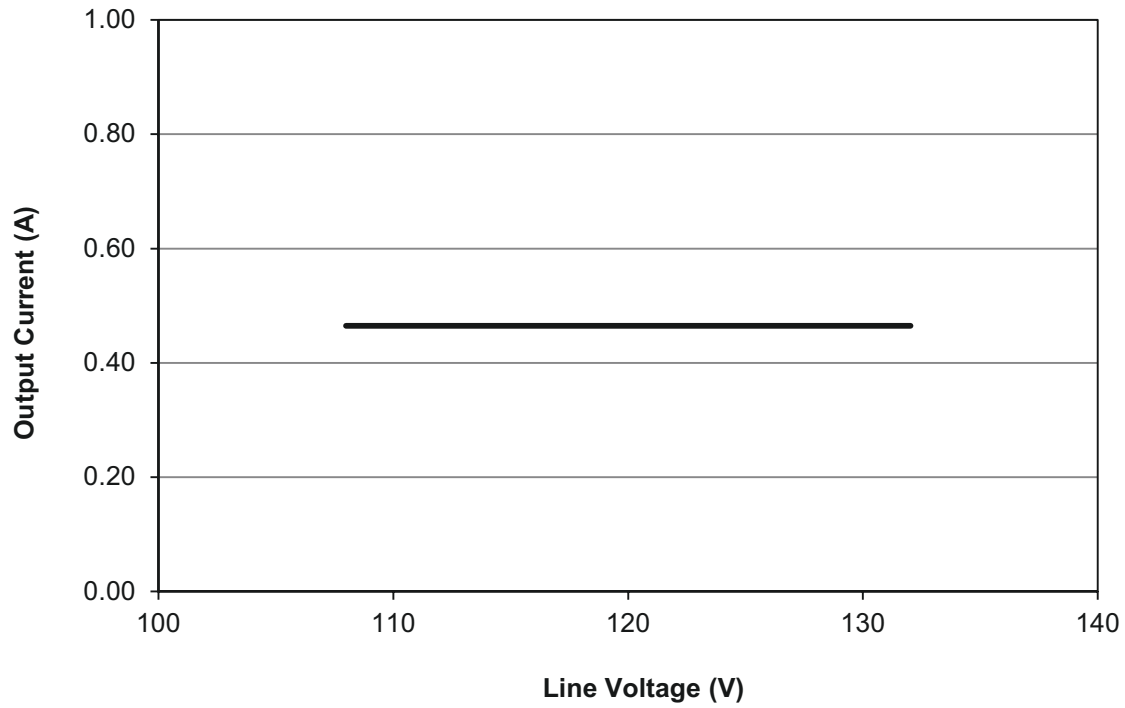


Figure 14. Output Current vs. Line Voltage, 108VAC to 132VAC

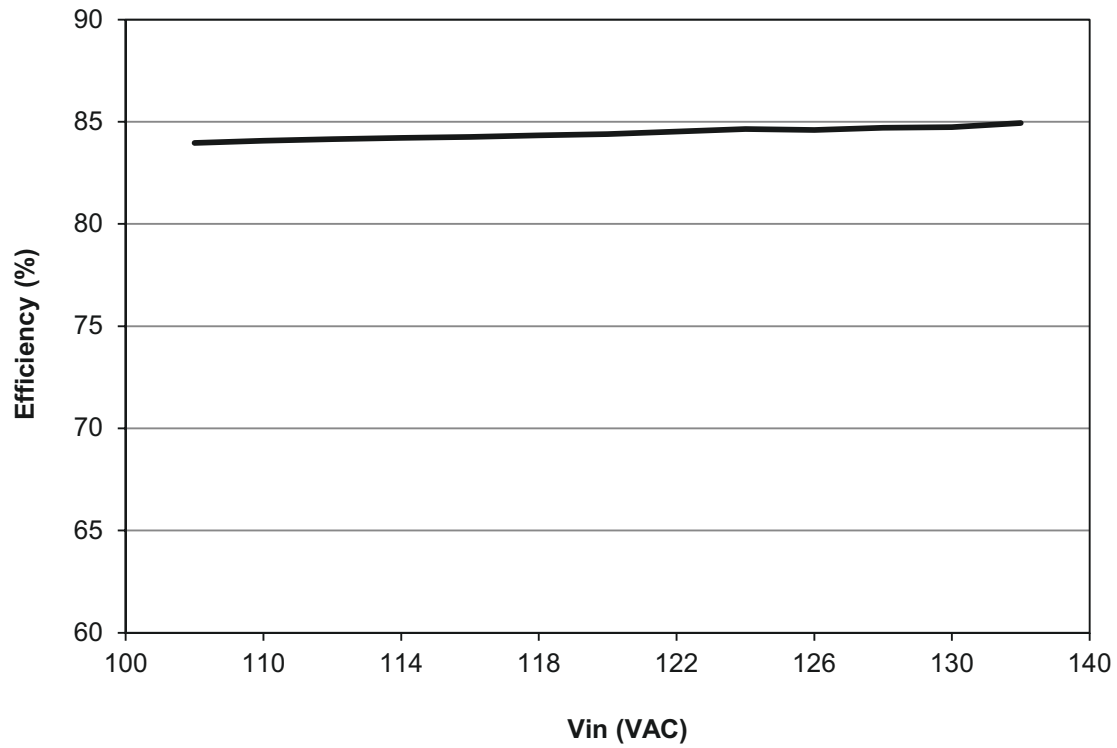


Figure 15. Typical Efficiency vs. Line Voltage, 108VAC to 132VAC

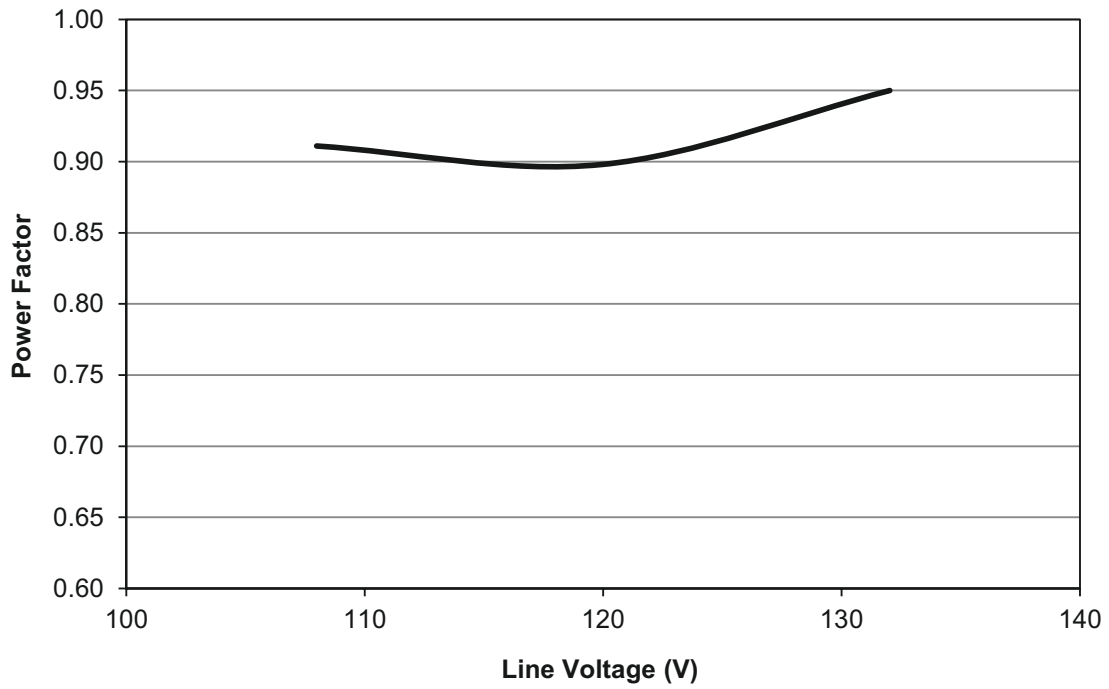


Figure 16. Power Factor vs. Line Voltage, 108VAC to 132VAC

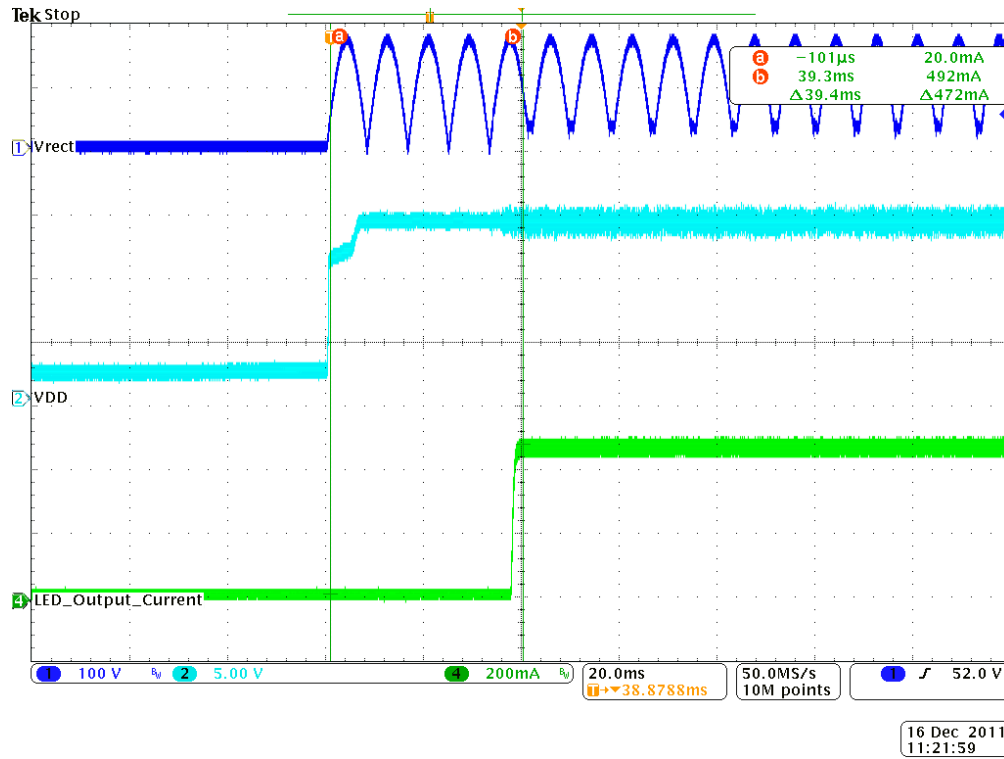


Figure 17. No-dimmer Mode, Startup 120 VAC

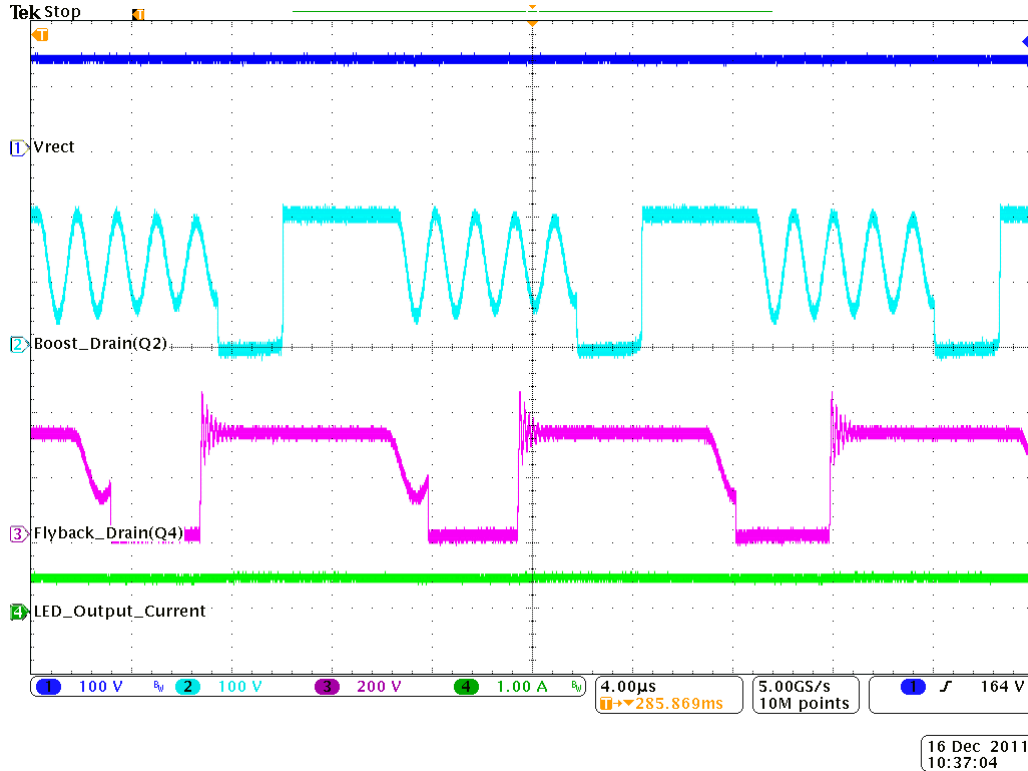
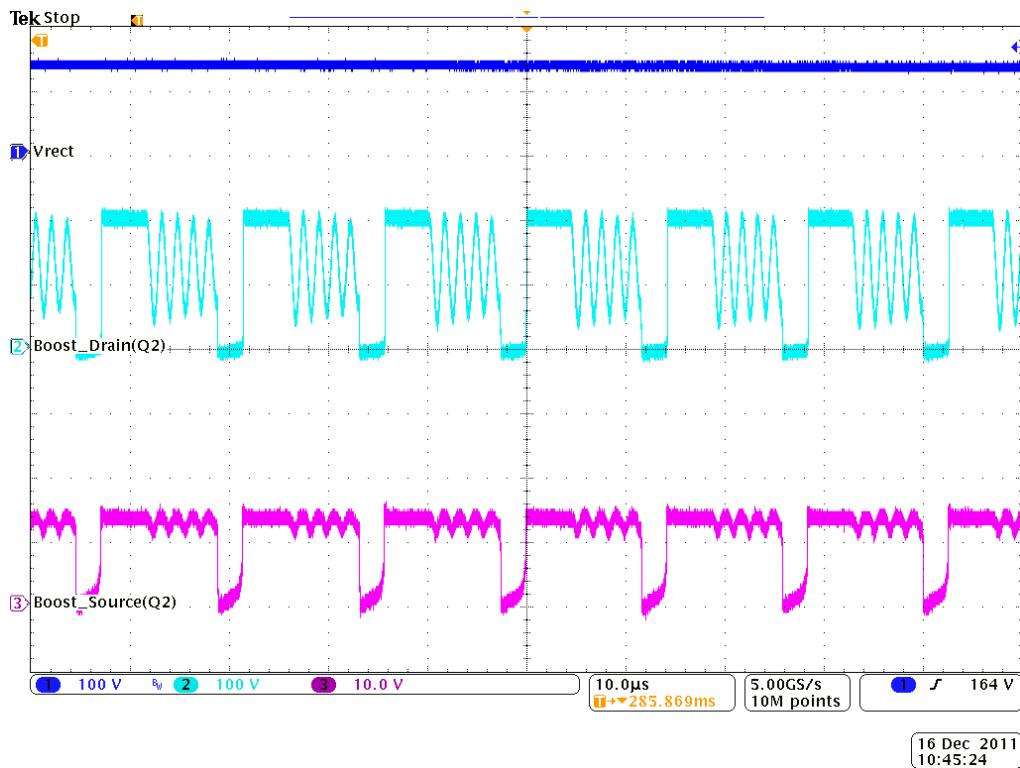
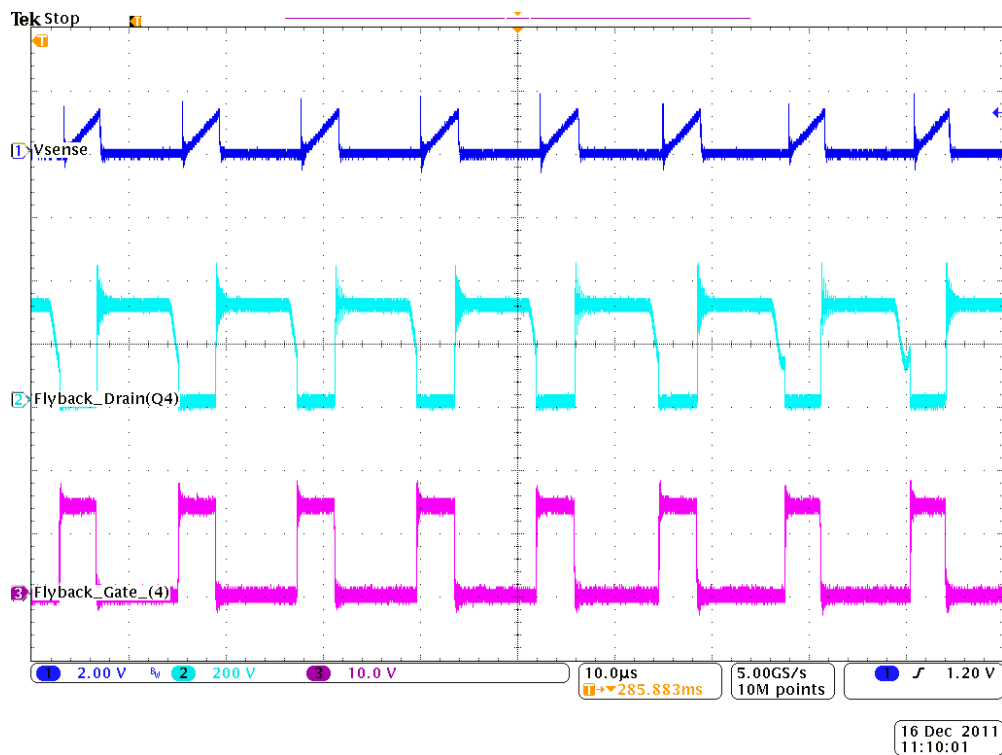


Figure 18. No-dimmer Mode, Steady-state, 120VAC


Figure 19. Boost FET, Q2, Waveform

Figure 20. Flyback FET, Q4, Waveform

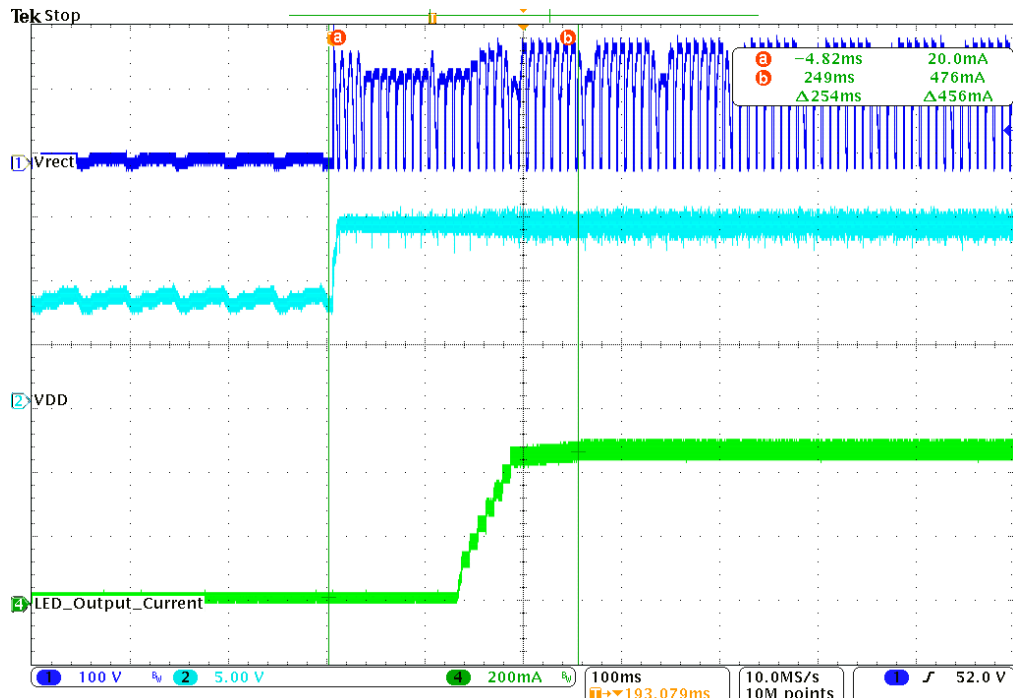

 16 Dec 2011
 11:37:34

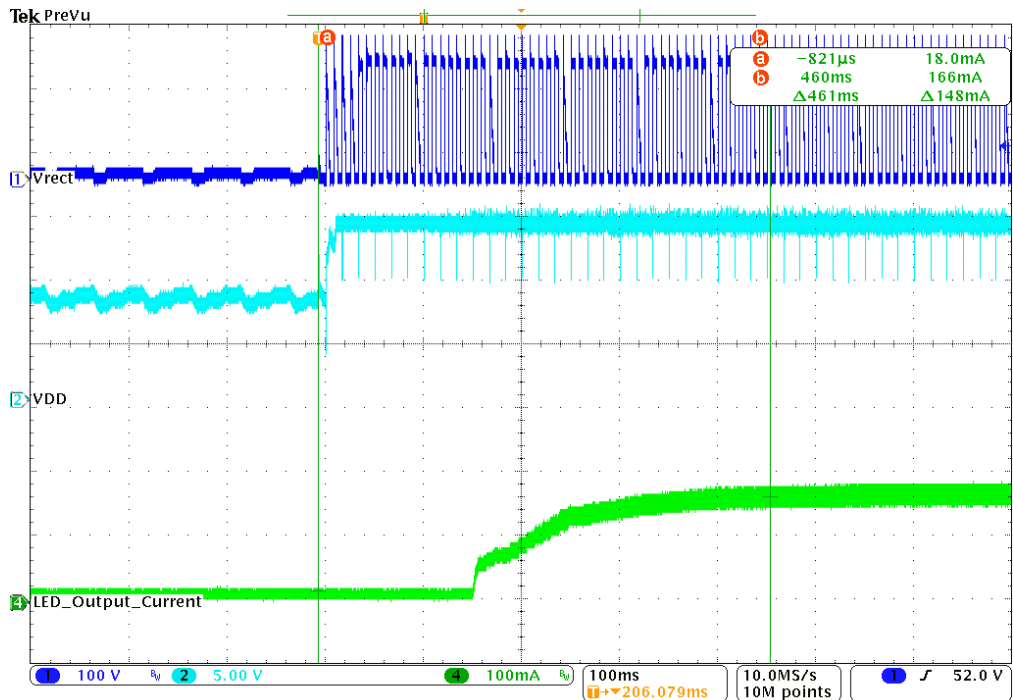
Figure 21. ILED at Maximum Dim Angle, Turn-on Waveforms

 16 Dec 2011
 11:39:41

Figure 22. ILED at Medium Dim Angle, Turn-on Waveforms

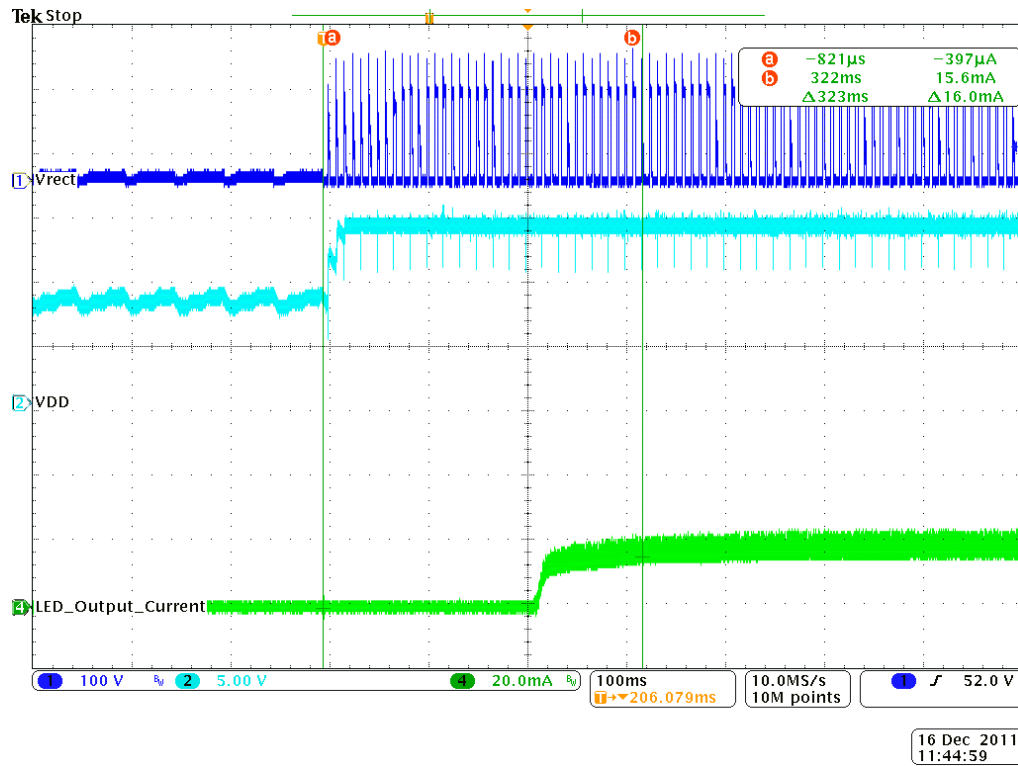


Figure 23. ILED at Minimum Dim Angle, Turn-on Waveforms

9. CONDUCTED EMI
Device Under Test: CRD1610-8W-Z

Operating Conditions: NOMNIAL

Test Specification: IEC 55022 Class B

Operator Name: JCM

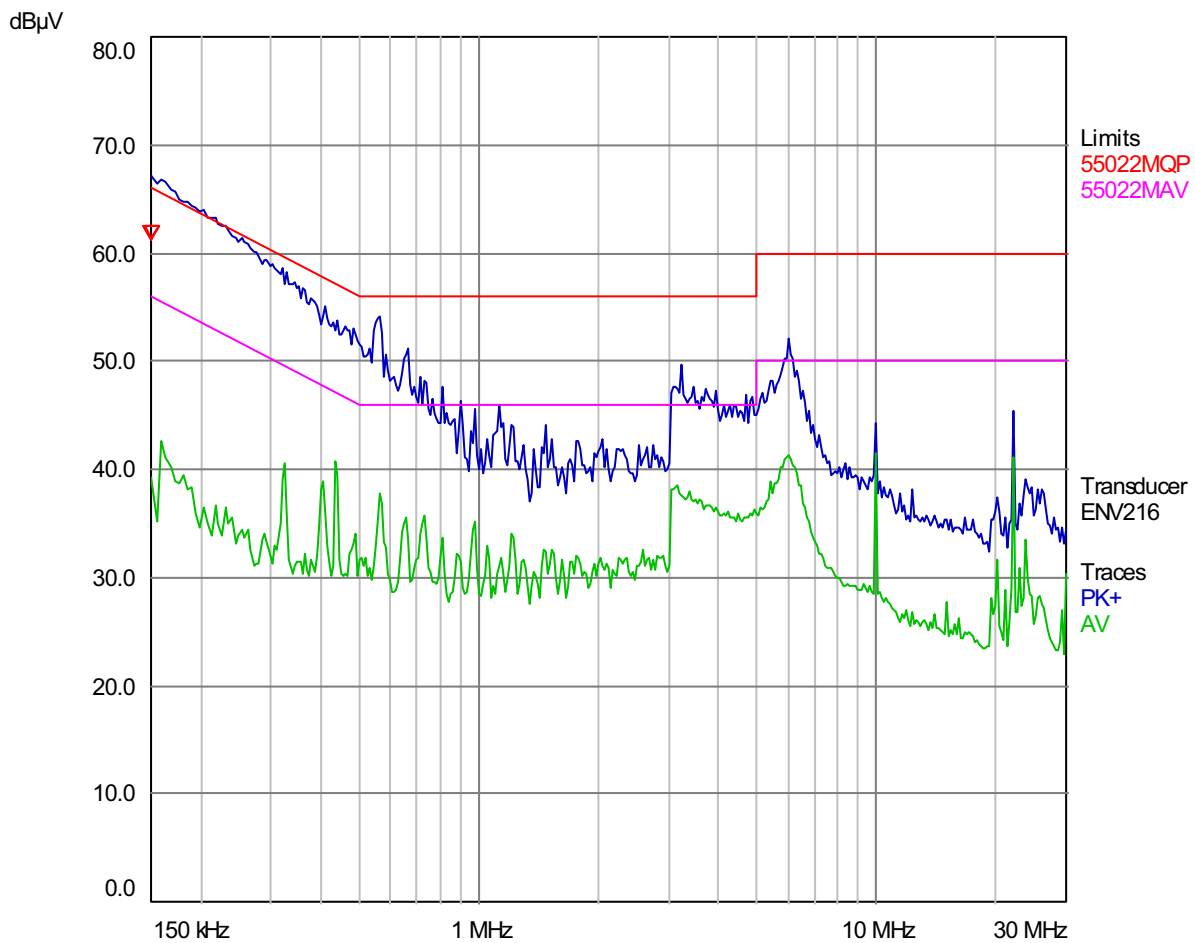
Scan Settings (1 Range)

Frequencies			Receiver Settings			
Start	Stop	Step	Res BW	M-Time	Atten	Preamp
150kHz	30MHz	4.5kHz	9kHz (6dB)	10ms	Auto	Off

Final Measurement
Detectors: QP, AV

Peaks: 25

Meas Time: 1s

Acc. Margin: 6dB

Figure 24. Conducted EMI
Final Measurement Results

Trace	Frequency (MHz)	Level (dBµV)	Limit (dBµV)	Delta Limit (dB)	Delta Ref (dB)	Comment
1QP	0.15	61.18	66.00	-4.82	Auto	L1/on

* = Limit Exceeded

10. REVISION HISTORY

Revision	Date	Changes
RD1	DEC 2011	Initial release.
RD2	JAN 2012	Content change to BOM and schematic.
RD3	FEB 2012	Content change to features.
RD4	JUL 2012	Corrected a typographical error.
RD5	FEB 2013	Corrected typographical errors.