

PVB

Low Profile SMT Push Switches



Features/Benefits

- Compact design
- Adapted for medium power applications
- SMD soldering process
- Tape & reel packaging
- RoHS compliant and compatible

Typical Applications

- Automotive (air conditioning, lighting)
- Industrial
- Control panels

Construction

FUNCTION: Momentary, Push-Push
 CONTACT ARRANGEMENT: SPDT (PVB4); DPDT (PVB6)
 SWITCHING MODE: Non-shorting
 TERMINALS: G termination
 PC Pins for THT version

Mechanical

TOTAL TRAVEL / LATCHING TRAVEL:
 OA: 2,3 mm
 EE: 2,3 / 1,5 mm
 OPERATING FORCE: 3N

Process

SOLDERING:
 Compatible with lead free soldering process

Packaging

PVB4 - 150 pieces
 PVB6 - 200 pieces per reel for SMT version
 PVB6 - 600 pieces per box for THT version

Electrical

SWITCHING POWER MAX.: PVB4: 1,4 W DC ; PVB6: 2,8 W DC
 SWITCHING VOLTAGE MAX.: 14 V DC
 SWITCHING CURRENT MAX.: PVB4: 100 mA DC; PVB6: 200 mA DC
 DIELECTRIC STRENGTH (50 Hz / 1 min): 500 V between open contacts
 OPERATING LIFE:
 PVB4 / PVB6

OA (momentary): ≥ 100,000 cycles
 EE (push-push): ≥ 100,000 cycles

CONTACT RESISTANCE: Initial ≤ 150 mΩ
 INSULATION RESISTANCE: ≥ 10⁸ Ω(100 VDC - 60s)

Environmental

OPERATING TEMPERATURE: -40°C to 80°C



How To Order

Our easy build-a-switch concept allows you to mix and match options to create the switch you need. To order, select desired option from each category and place it in the appropriate box. **Some of the configurations may not be available or could require some development.**

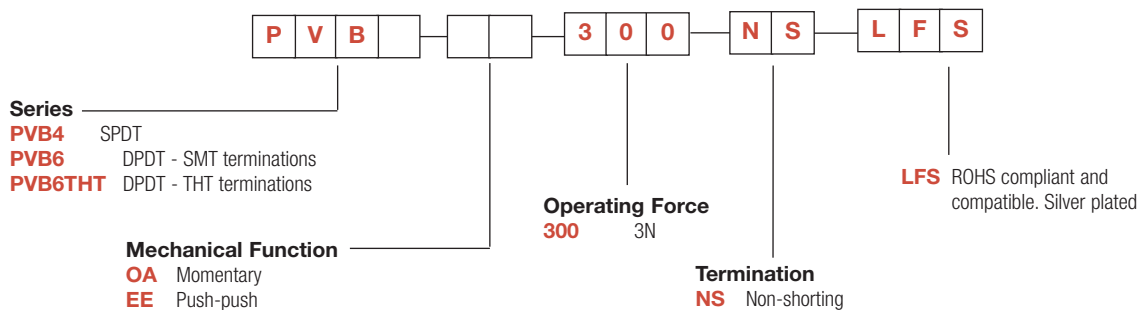

PVB Low Profile SMT Push Switches

PVB4 OA MOMENTARY

ELECTRICAL SCHEMATIC

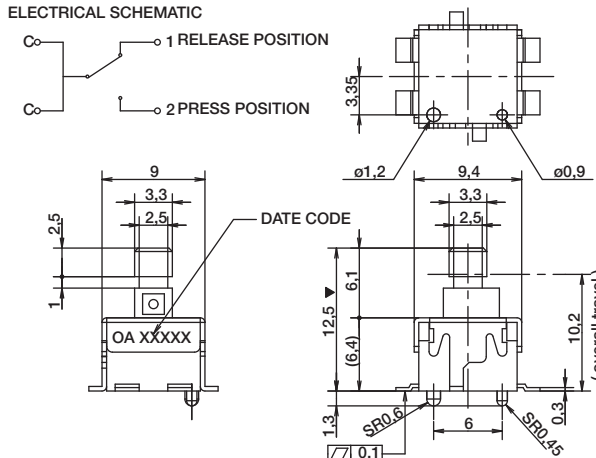
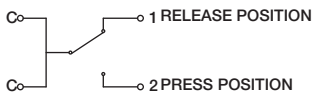

Year
Week
Day for the week

X X X X X For example 12022 indicates 2012 YEAR - 02 WEEK - 2 TUESDAY

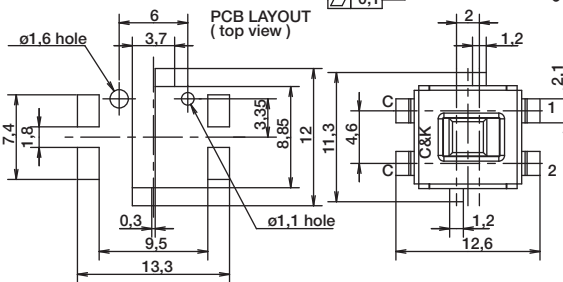
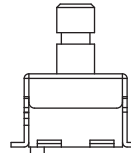

PVB4 EE PUSH PUSH

ELECTRICAL SCHEMATIC

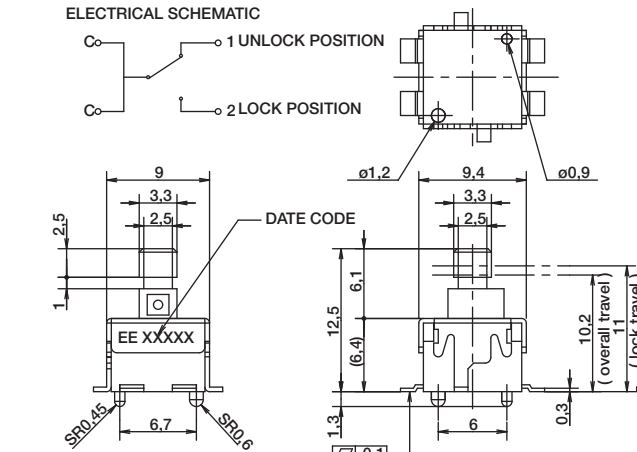
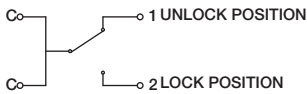

Year
Week
Day for the week

X X X X X For example 12022 indicates 2012 YEAR - 02 WEEK - 2 TUESDAY

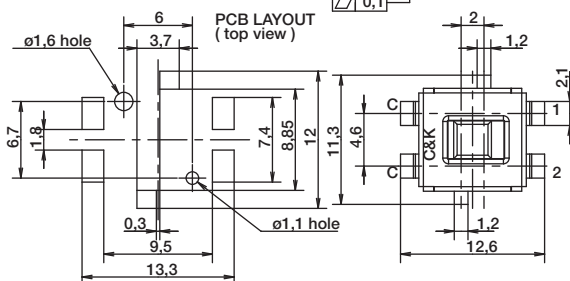
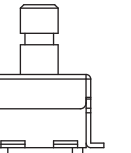

PVB Low Profile SMT Push Switches

PVB6 OA MOMENTARY

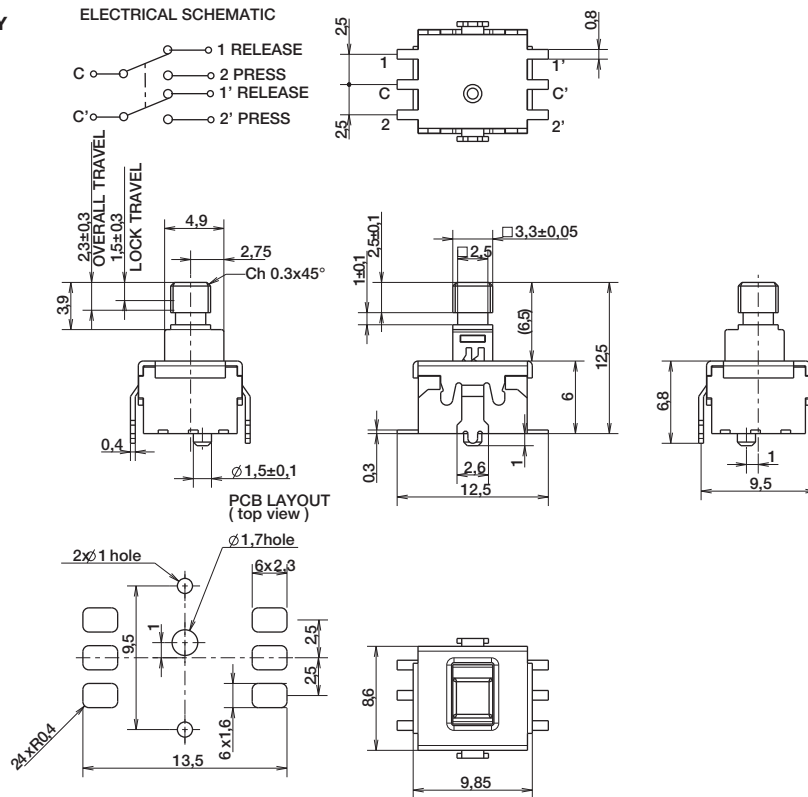

PVB6 EE PUSH PUSH

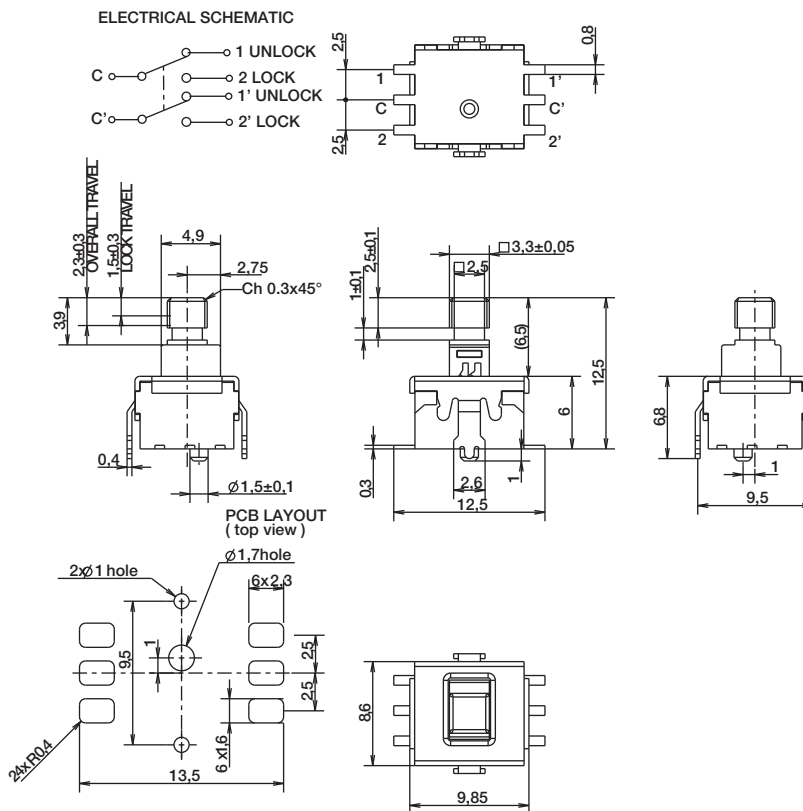

D

Key Switches

PVB Low Profile Push Switches

PVB6 THT OA MOMENTARY

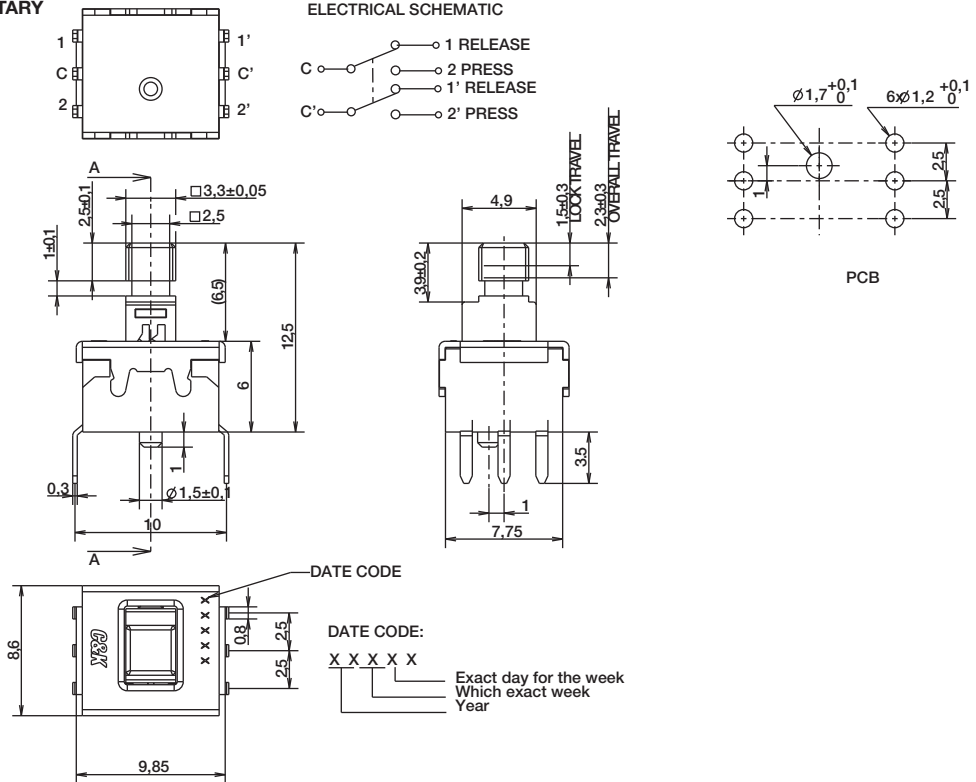

PVB6 THT EE PUSH PUSH

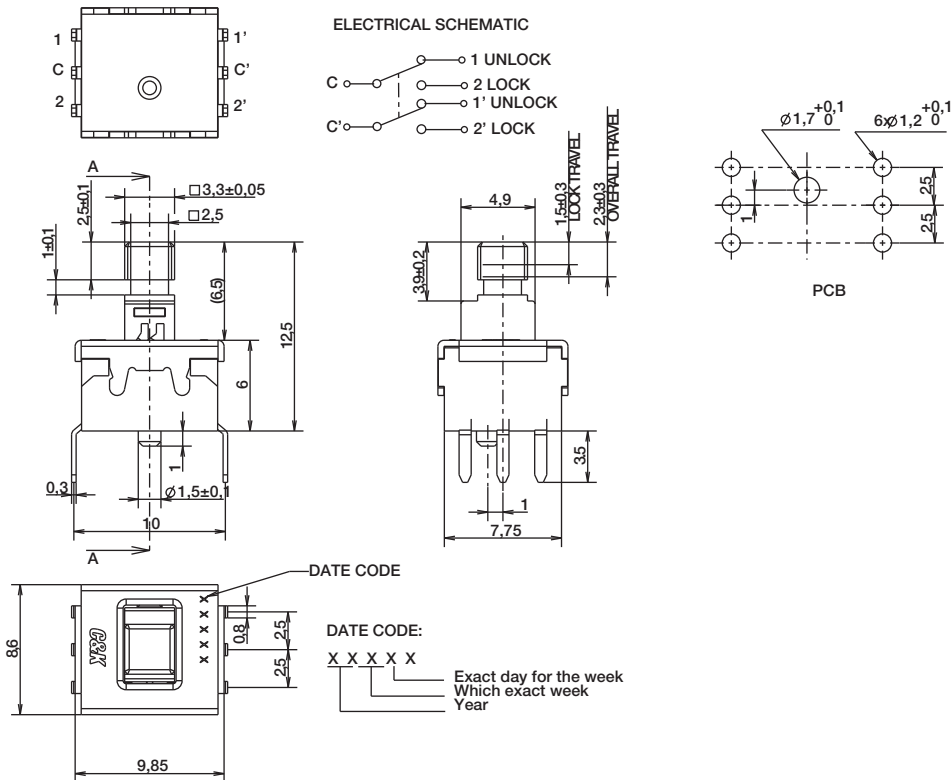

PVB Low Profile Push Switches

TAPE & REEL

PVB4

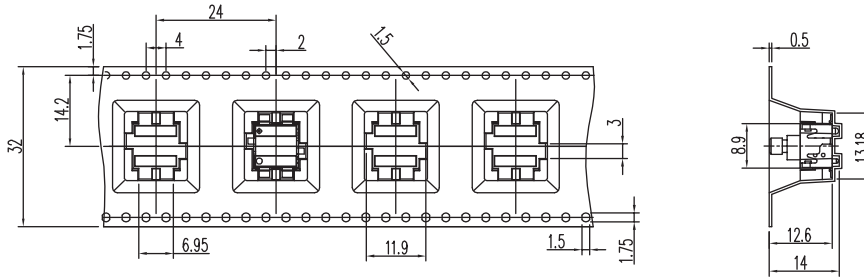

PVB6

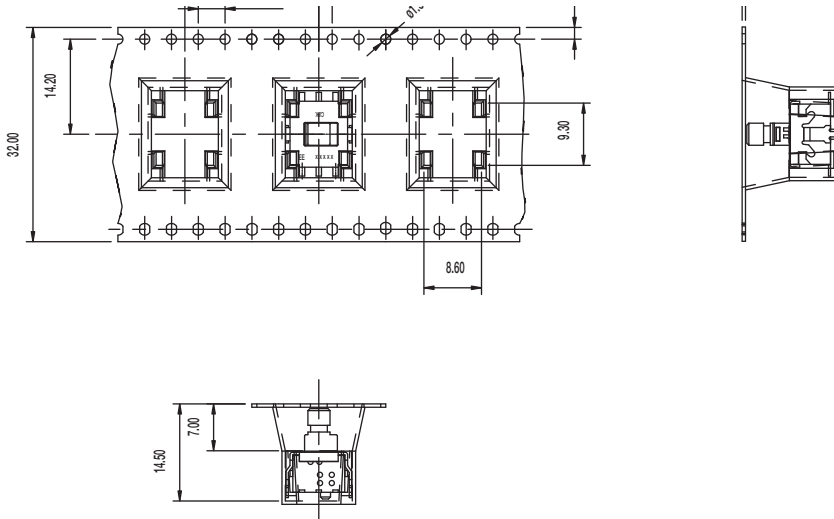

D

Key Switches