

MSA-0986

Cascadable Silicon Bipolar MMIC Amplifier



Data Sheet

Description

The MSA-0986 is a high performance silicon bipolar Monolithic Microwave Integrated Circuit (MMIC) housed in a low cost, surface mount plastic package. This MMIC is designed for very wide bandwidth industrial and commercial applications that require flat gain and low VSWR.

The MSA-series is fabricated using Avago's 10 GHz f_T , 25 GHz f_{MAX} , silicon bipolar MMIC process which uses nitride self-alignment, ion implantation, and gold metallization to achieve excellent performance, uniformity and reliability. The use of an external bias resistor for temperature and current stability also allows bias flexibility.

Features

- Broadband, Minimum Ripple Cascadable 50Ω Gain Block
- 7.2 ± 0.5 dB Typical Gain Flatness from 0.1 to 3.0 GHz
- 3 dB Bandwidth: 0.1 to 5.5 GHz
- 10.5 dBm Typical P_{1dB} at 2.0 GHz
- Surface Mount Plastic Package
- Tape-and-Reel Packaging Option Available
- Lead-free Option Available

86 Plastic Package

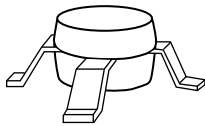

Typical Biasing Configuration

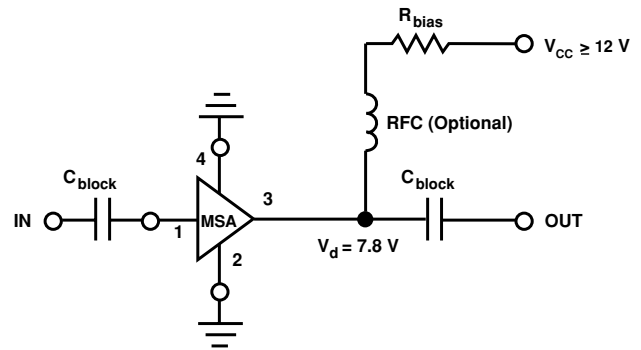

MSA-0986 Absolute Maximum Ratings

Parameter	Absolute Maximum ^[1]
Device Current	65 mA
Power Dissipation ^[2,3]	500 mW
RF Input Power	+13 dBm
Junction Temperature	150°C
Storage Temperature	-65 to +150°C

Thermal Resistance^{[2]:}

$$\theta_{jc} = 140^{\circ}\text{C/W}$$

Notes:

1. Permanent damage may occur if any of these limits are exceeded.
2. $T_{\text{CASE}} = 25^{\circ}\text{C}$.
3. Derate at $7.1 \text{ mW}/^{\circ}\text{C}$ for $T_{\text{C}} > 80^{\circ}\text{C}$.

Electrical Specifications^[1], $T_{\text{A}} = 25^{\circ}\text{C}$

Symbol	Parameters and Test Conditions: $I_{\text{d}} = 35 \text{ mA}$, $Z_{\text{o}} = 50 \Omega$	Units	Min.	Typ.	Max.
G_{P}	Power Gain ($ S_{21} ^2$) $f = 2.0 \text{ GHz}$	dB	6.0	7.2	
ΔG_{P}	Gain Flatness $f = 0.1 \text{ to } 3.0 \text{ GHz}$	dB		± 0.5	
$f_{3 \text{ dB}}$	3 dB Bandwidth ^[2]	GHz		5.5	
VSWR	Input VSWR $f = 1.0 \text{ to } 3.0 \text{ GHz}$			1.6:1	
	Output VSWR $f = 1.0 \text{ to } 3.0 \text{ GHz}$			1.8:1	
NF	50 Ω Noise Figure $f = 2.0 \text{ GHz}$	dB		6.2	
$P_{1 \text{ dB}}$	Output Power at 1 dB Gain Compression $f = 2.0 \text{ GHz}$	dBm		10.5	
IP_3	Third Order Intercept Point $f = 2.0 \text{ GHz}$	dBm		23.0	
t_{D}	Group Delay $f = 2.0 \text{ GHz}$	psec		95	
V_{d}	Device Voltage	V	6.2	7.8	9.4
dV/dT	Device Voltage Temperature Coefficient	$\text{mV}/^{\circ}\text{C}$		-16.0	

Notes:

1. The recommended operating current range for this device is 25 to 45 mA. Typical performance as a function of current is on the following page.
2. Referenced from 0.1 GHz gain (G_{P}).

Ordering Information

Part Numbers	No. of Devices	Comments
MSA-0986-BLK	100	Bulk
MSA-0986-BLKG	100	Bulk
MSA-0986-TR1	1000	7" Reel
MSA-0986-TR1G	1000	7" Reel
MSA-0986-TR2	4000	13" Reel
MSA-0986-TR2G	4000	13" Reel

Note: Order part number with a "G" suffix if lead-free option is desired.

MSA-0986 Typical Scattering Parameters ($Z_0 = 50 \Omega$, $T_A = 25^\circ\text{C}$, $I_d = 35 \text{ mA}$)

Freq. GHz	S ₁₁		S ₂₁			S ₁₂			S ₂₂		k
	Mag	Ang	dB	Mag	Ang	dB	Mag	Ang	Mag	Ang	
0.02	.36	-105	11.4	3.72	145	-14.1	.198	18	.38	-102	0.73
0.05	.24	-145	8.5	2.65	156	-13.7	.205	5	.25	-143	1.08
0.1	.22	-164	7.7	2.43	166	-13.5	.211	4	.22	-158	1.17
0.2	.21	-179	7.5	2.37	167	-13.5	.212	1	.22	-172	1.20
0.4	.21	165	7.4	2.34	162	-13.4	.214	-1	.22	179	1.20
0.6	.22	155	7.4	2.33	156	-13.5	.212	-2	.22	175	1.21
0.8	.22	145	7.3	2.33	149	-13.4	.213	-2	.23	171	1.21
1.0	.23	136	7.3	2.32	142	-13.4	.214	-4	.24	167	1.20
1.5	.24	118	7.2	2.30	125	-13.3	.217	-6	.26	157	1.19
2.0	.25	106	7.2	2.28	109	-13.0	.224	-10	.28	148	1.16
2.5	.26	100	7.2	2.29	94	-13.0	.224	-12	.33	139	1.15
3.0	.26	94	7.1	2.26	77	-13.0	.224	-15	.34	128	1.15
3.5	.26	95	7.0	2.23	60	-12.8	.229	-21	.36	116	1.14
4.0	.28	96	6.7	2.17	43	-13.1	.221	-25	.35	104	1.18
4.5	.31	100	6.5	2.10	26	-13.6	.210	-31	.32	94	1.23
5.0	.37	101	6.0	2.00	9	-14.2	.196	-35	.26	86	1.30
5.5	.44	97	5.4	1.86	-7	-14.9	.181	-38	.19	88	1.38
6.0	.51	94	4.6	1.69	-22	-15.8	.162	-37	.14	107	1.47

Typical Performance, $T_A = 25^\circ\text{C}$

(unless otherwise noted)

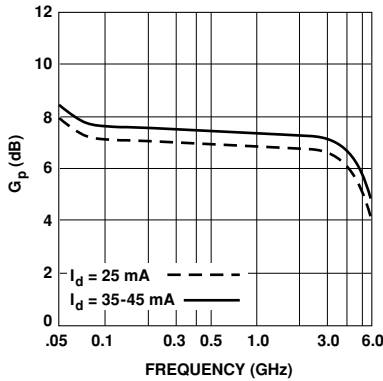

Figure 1. Typical Power Gain vs. Frequency.

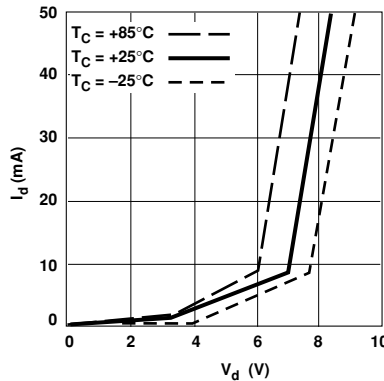

Figure 2. Device Current vs. Voltage.

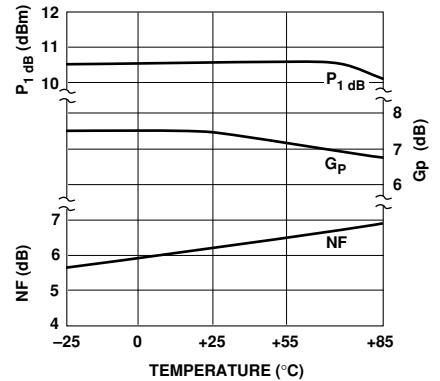

Figure 3. Output Power at 1 dB Gain Compression, Noise Figure and Power Gain vs. Case Temperature, $f = 2.0 \text{ GHz}$, $I_d = 35 \text{ mA}$.

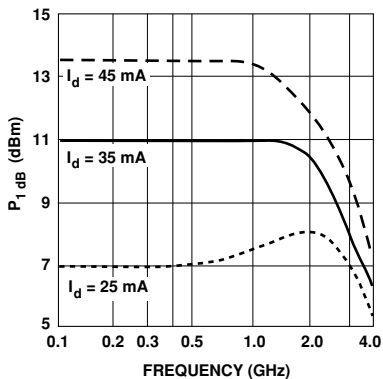

Figure 4. Output Power at 1 dB Gain Compression vs. Frequency.

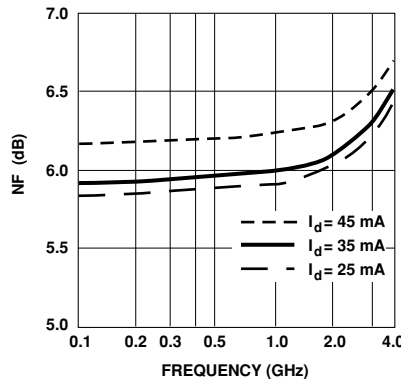
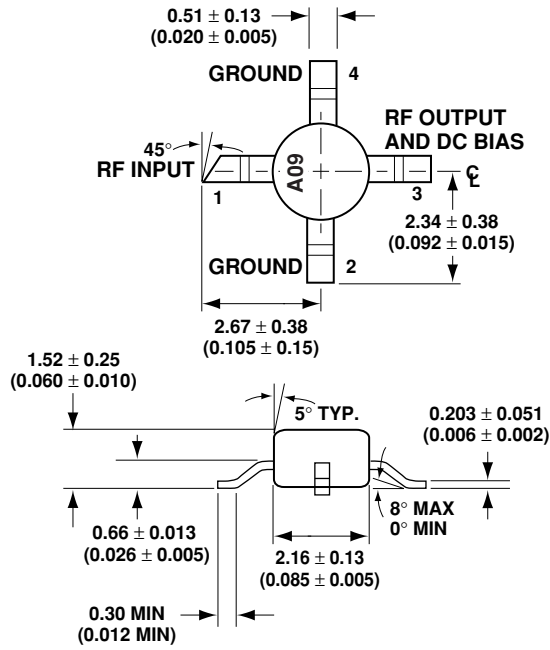

Figure 5. Noise Figure vs. Frequency.

86 Plastic Package Dimensions



DIMENSIONS ARE IN MILLIMETERS (INCHES)

For product information and a complete list of distributors, please go to our web site:
www.avagotech.com

Avago, Avago Technologies, and the A logo are trademarks of Avago Technologies, Limited in the United States and other countries.
 Data subject to change. Copyright © 2006 Avago Technologies, Limited. All rights reserved.
 Obsoletes 5965-9552EN
 5989-2745EN September 16, 2006

AVAGO
 TECHNOLOGIES