

Data Sheet

Description

The MSA-0870 is a high performance silicon bipolar Monolithic Microwave Integrated Circuit (MMIC) housed in a hermetic, high reliability package. This MMIC is designed for use as a general purpose 50Ω gain block above 0.5 GHz and can be used as a high gain transistor below this frequency. Typical applications include narrow and moderate band IF and RF amplifiers in industrial and military applications.

The MSA-series is fabricated using Avago's 10 GHz f_T , 25 GHz f_{MAX} , silicon bipolar MMIC process which uses nitride self-alignment, ion implantation, and gold metallization to achieve excellent performance, uniformity and reliability. The use of an external bias resistor for temperature and current stability also allows bias flexibility.

Features

- Usable Gain to 6.0 GHz
- High Gain:
32.5 dB Typical at 0.1 GHz
23.5 dB Typical at 1.0 GHz
- Low Noise Figure:
3.0 dB Typical at 1.0 GHz
- Hermetic Gold-ceramic Microstrip Package

70 mil Package

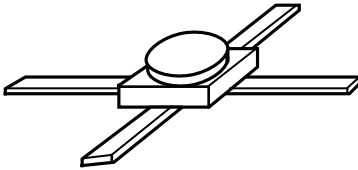

Typical Biasing Configuration

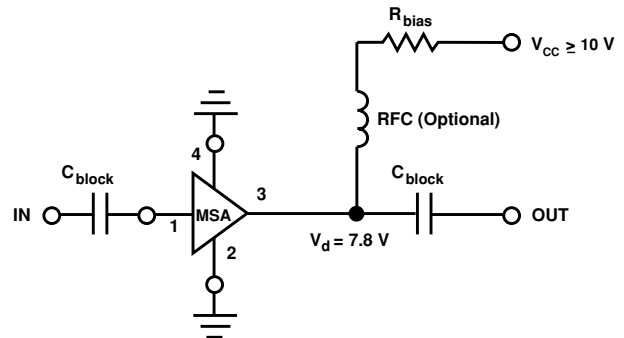

MSA-0870 Absolute Maximum Ratings

Parameter	Absolute Maximum ^[1]
Device Current	80 mA
Power Dissipation ^[2,3]	750 mW
RF Input Power	+13 dBm
Junction Temperature	200°C
Storage Temperature	-65°C to 200°C

Thermal Resistance^[2,4]:

$$\theta_{jc} = 150^{\circ}\text{C/W}$$

Notes:

1. Permanent damage may occur if any of these limits are exceeded.
2. $T_{\text{CASE}} = 25^{\circ}\text{C}$.
3. Derate at 6.7 mW/°C for $T_{\text{C}} > 88^{\circ}\text{C}$.
4. The small spot size of this technique results in a higher, though more accurate determination of θ_{jc} than do alternate methods.

Electrical Specifications^[1], $T_{\text{A}} = 25^{\circ}\text{C}$

Symbol	Parameters and Test Conditions: $I_{\text{d}} = 36 \text{ mA}$, $Z_0 = 50 \Omega$	Units	Min.	Typ.	Max.	
G_{p}	Power Gain ($ S_{21} ^2$)	$f = 0.1 \text{ GHz}$			32.5	
		$f = 1.0 \text{ GHz}$		22.0	23.5	
		$f = 4.0 \text{ GHz}$			11.0	12.0
VSWR	Input VSWR	$f = 1.0 \text{ to } 3.0 \text{ GHz}$			2.0:1	
	Output VSWR	$f = 1.0 \text{ to } 3.0 \text{ GHz}$			1.9:1	
NF	50 Ω Noise Figure	$f = 1.0 \text{ GHz}$			3.0	
$P_{1 \text{ dB}}$	Output Power at 1 dB Gain Compression	$f = 1.0 \text{ GHz}$			12.5	
IP_3	Third Order Intercept Point	$f = 1.0 \text{ GHz}$			27.0	
t_{D}	Group Delay	$f = 1.0 \text{ GHz}$			125	
V_{d}	Device Voltage		V	7.0	7.8	8.4
dV/dT	Device Voltage Temperature Coefficient		mV/°C		-17.0	

Note:

1. The recommended operating current range for this device is 20 to 40 mA.
Typical performance as a function of current is on the following page.

MSA-0870 Typical Scattering Parameters^[1] ($Z_0 = 50 \Omega$, $T_A = 25^\circ\text{C}$, $I_d = 36 \text{ mA}$)

Freq. GHz	S_{11}			S_{21}			S_{12}		S_{22}		k
	Mag	Ang	dB	Mag	Ang	dB	Mag	Ang	Mag	Ang	
0.1	.65	-19	32.5	42.04	161	-36.3	.015	40	.64	-22	0.78
0.2	.60	-35	31.5	37.54	145	-33.7	.021	47	.58	-43	0.66
0.4	.48	-60	29.1	28.49	122	-30.5	.030	51	.47	-74	0.64
0.6	.40	-76	26.8	21.90	108	-28.0	.040	50	.38	-97	0.72
0.8	.35	-88	24.9	17.48	97	-26.2	.049	50	.33	-113	0.78
1.0	.32	-102	23.4	14.85	87	-24.9	.057	51	.28	-128	0.83
1.5	.29	-118	20.1	10.14	70	-23.0	.071	47	.22	-151	0.91
2.0	.30	-133	17.6	7.55	56	-21.9	.081	45	.16	-167	0.98
2.5	.31	-139	15.6	6.01	49	-20.0	.100	46	.12	-172	1.02
3.0	.32	-149	13.8	4.87	39	-19.5	.106	41	.07	-170	1.11
3.5	.34	-159	12.2	4.09	28	-18.4	.121	35	.07	-143	1.12
4.0	.34	-168	10.8	3.48	17	-17.7	.131	31	.12	-112	1.16
5.0	.33	161	8.4	2.63	-3	-16.6	.147	21	.19	-103	1.26
6.0	.39	128	6.2	2.04	-22	-16.2	.155	10	.21	-115	1.36

Typical Performance, $T_A = 25^\circ\text{C}$

(unless otherwise noted)

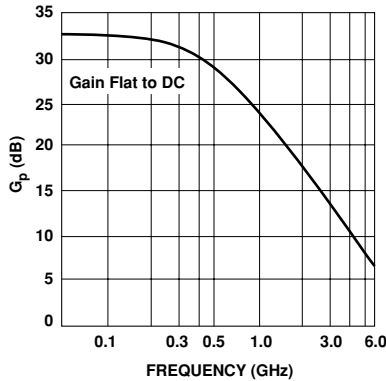

Figure 1. Typical Power Gain vs. Frequency, $I_d = 36 \text{ mA}$.

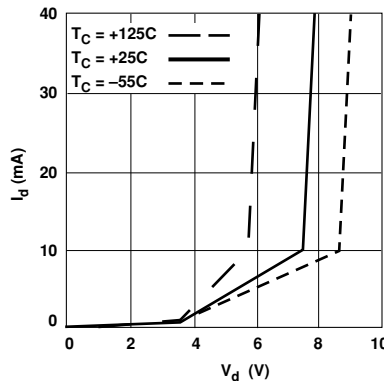

Figure 2. Device Current vs. Voltage.

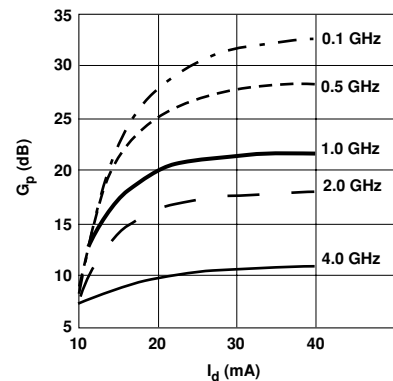

Figure 3. Power Gain vs. Current.

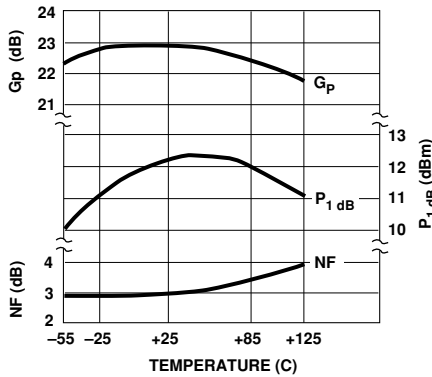

Figure 4. Output Power at 1 dB Gain Compression, NF and Power Gain vs. Case Temperature, $f = 1.0 \text{ GHz}$, $I_d = 36 \text{ mA}$.

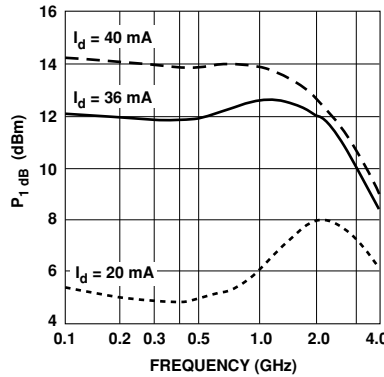

Figure 5. Output Power at 1 dB Gain Compression vs. Frequency.

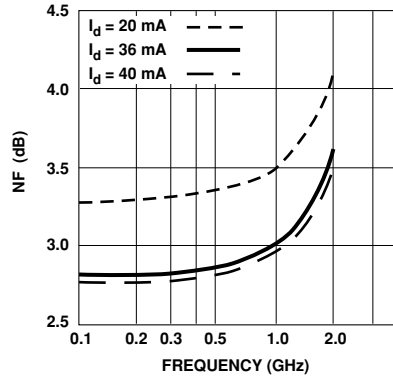
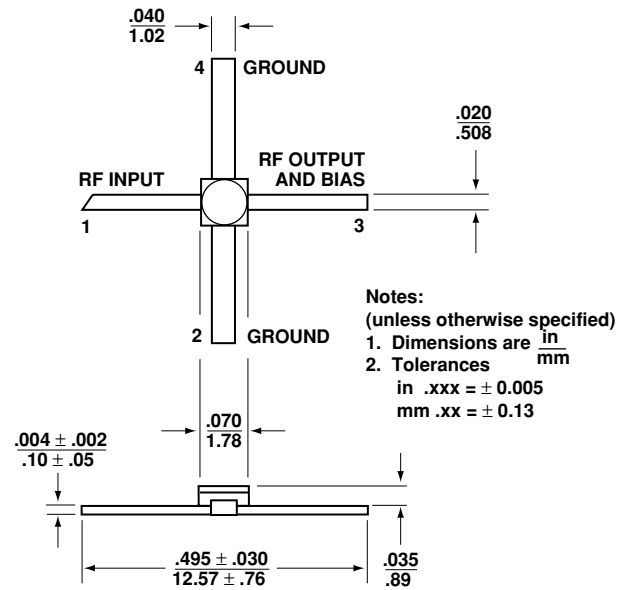

Figure 6. Noise Figure vs. Frequency.

Ordering Information

Part Numbers	No. of Devices	Comments
MSA-0870	100	Bulk

70 mil Package Dimensions



For product information and a complete list of distributors, please go to our web site: www.avagotech.com

Avago, Avago Technologies, and the A logo are trademarks of Avago Technologies, Limited in the United States and other countries. Data subject to change. Copyright © 2008 Avago Technologies, Limited. All rights reserved. Obsoletes 5989-2768EN AV02-1231EN - May 15, 2008

AVAGO
TECHNOLOGIES