

Agilent MSA-0611 Cascadable Silicon Bipolar MMIC Amplifier

Data Sheet

Description

The MSA-0611 is a low cost silicon bipolar Monolithic Microwave Integrated Circuit (MMIC) housed in the surface mount plastic SOT-143 package. This MMIC is designed for use as a general purpose 50 Ω gain block. Typical applications include narrow and broad band IF and RF amplifiers in commercial and industrial applications.

The MSA-series is fabricated using Agilent's 10 GHz f_T , 25 GHz f_{MAX} , silicon bipolar MMIC process which uses nitride self-alignment, ion implantation, and gold metallization to achieve excellent performance, uniformity and reliability. The use of an external bias resistor for temperature and current stability also allows bias flexibility.

SOT-143 Package

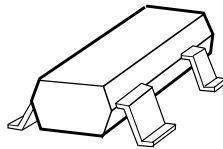

Features

- **Cascadable 50 Ω Gain Block**
- **3 dB Bandwidth:**
DC to 0.7 GHz
- **High Gain:**
18.0 dB Typical at 0.5 GHz
- **Low Noise Figure:**
3.0 dB Typical at 0.5 GHz
- **Low Cost Surface Mount Plastic Package**
- **Tape-and-Reel Packaging Option Available**
- **Lead-free Option Available**

Typical Biasing Configuration

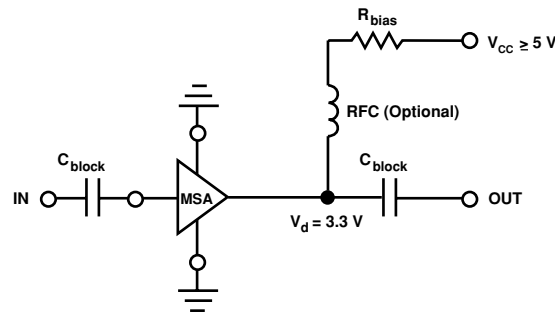

MSA-0611 Absolute Maximum Ratings

Parameter	Absolute Maximum ^[1]
Device Current	40 mA
Power Dissipation ^[2,3]	125 mW
RF Input Power	+13 dBm
Junction Temperature	150°C
Storage Temperature	-65 to 150°C

Thermal Resistance^[2]:

$$\theta_{jc} = 505^{\circ}\text{C}/\text{W}$$

Notes:

1. Permanent damage may occur if any of these limits are exceeded.
2. $T_{\text{CASE}} = 25^{\circ}\text{C}$.
3. Derate at 2.0 mW/°C for $T_{\text{C}} > 87^{\circ}\text{C}$.

Electrical Specifications^[1], $T_{\text{A}} = 25^{\circ}\text{C}$

Symbol	Parameters and Test Conditions: $I_{\text{d}} = 16 \text{ mA}$, $Z_{\text{o}} = 50 \Omega$	Units	Min.	Typ.	Max.
G_{P}	Power Gain ($ S_{21} ^2$) f = 0.1 GHz f = 0.5 GHz	dB	16.0	19.5 18.0	
ΔG_{P}	Gain Flatness f = 0.1 to 0.5 GHz	dB		± 0.8	
$f_{3 \text{ dB}}$	3 dB Bandwidth	GHz		0.7	
VSWR	Input VSWR f = 0.1 to 1.5 GHz			1.6:1	
	Output VSWR f = 0.1 to 1.5 GHz			1.5:1	
NF	50 Ω Noise Figure f = 0.5 GHz	dB		3.0	
$P_{1 \text{ dB}}$	Output Power at 1 dB Gain Compression f = 0.5 GHz	dBm		2.0	
IP_3	Third Order Intercept Point f = 0.5 GHz	dBm		14.0	
t_{D}	Group Delay f = 0.5 GHz	psec		225	
V_{d}	Device Voltage $T_{\text{C}} = 25^{\circ}\text{C}$	V	2.6	3.3	4.0
dV/dT	Device Voltage Temperature Coefficient	mV/°C		-8.0	

Note:

1. The recommended operating current range for this device is 12 to 20 mA. Typical gain performance as a function of current is on the following page.

Ordering Information

Part Numbers	No. of Devices	Comments
MSA-0611-BLK	100	Bulk
MSA-0611-BLKG	100	Bulk
MSA-0611-TR1	3000	7" Reel
MSA-0611-TR1G	3000	7" Reel
MSA-0611-TR2	10000	13" Reel
MSA-0611-TR2G	10000	13" Reel

Note: Order part number with a "G" suffix if lead-free option is desired.

MSA-0611 Typical Scattering Parameters ($Z_0 = 50 \Omega$, $T_A = 25^\circ\text{C}$, $I_d = 16 \text{ mA}$)

Freq. GHz	S_{11}		S_{21}			S_{12}			S_{22}		k
	Mag	Ang	dB	Mag	Ang	dB	Mag	Ang	Mag	Ang	
0.1	.04	-176	19.6	9.53	170	-23.0	.071	6	.04	-57	1.07
0.2	.03	-163	19.3	9.25	160	-22.7	.073	10	.07	-82	1.07
0.3	.03	-149	18.9	8.79	150	-22.8	.072	14	.09	-97	1.10
0.4	.04	-132	18.5	8.38	141	-21.9	.080	17	.11	-111	1.07
0.5	.05	-127	18.0	7.96	133	-21.6	.083	21	.13	-122	1.07
0.6	.07	-123	17.3	7.33	125	-21.2	.087	23	.15	-131	1.07
0.8	.10	-129	16.2	6.46	111	-19.7	.103	25	.17	-147	1.04
1.0	.13	-139	15.0	5.64	98	-19.0	.112	28	.18	-160	1.06
1.5	.22	-164	12.5	4.22	73	-17.1	.139	25	.19	175	1.07
2.0	.31	171	10.1	3.20	53	-16.1	.157	21	.19	160	1.13
2.5	.39	158	8.1	2.55	42	-15.4	.169	22	.20	153	1.19
3.0	.45	144	6.3	2.07	28	-15.0	.178	18	.19	150	1.26
3.5	.50	132	4.7	1.72	16	-14.6	.185	15	.16	152	1.33
4.0	.52	121	3.4	1.48	4	-14.1	.197	11	.14	166	1.37

Typical Performance, $T_A = 25^\circ\text{C}$

(unless otherwise noted)

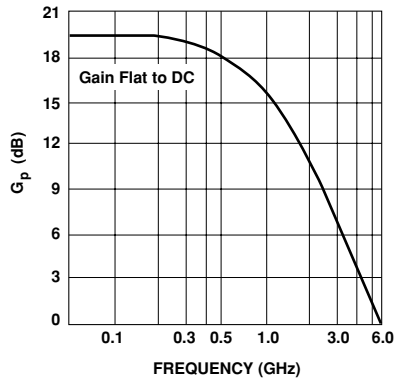
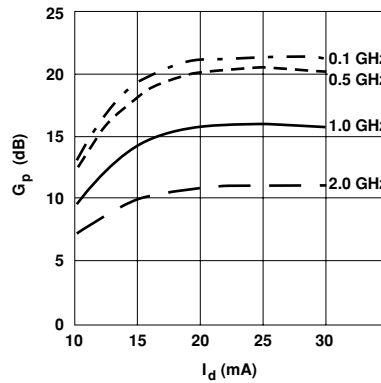
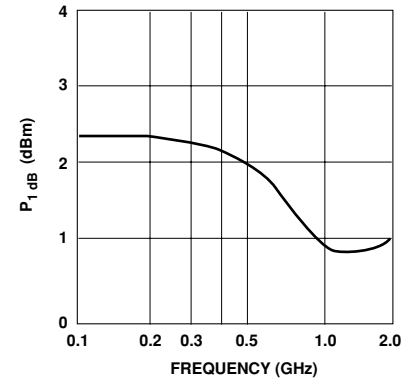
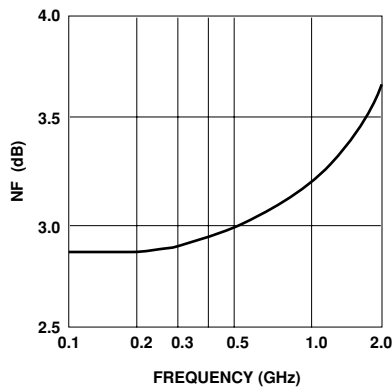
Figure 1. Power Gain vs. Frequency,
 $T_A = 25^\circ\text{C}$, $I_d = 16 \text{ mA}$.

Figure 2. Power Gain vs. Current.

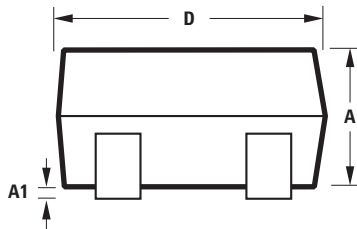
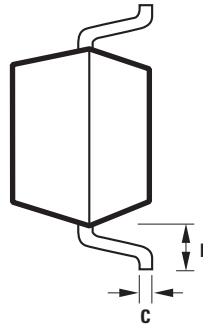
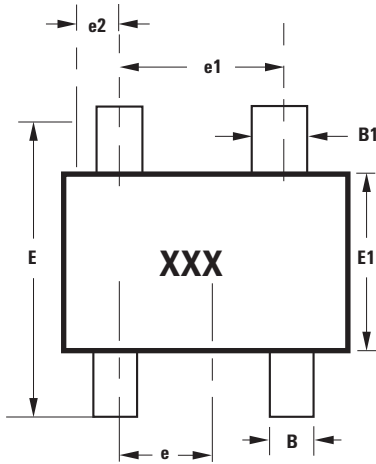
Figure 3. Output Power @ 1 dB Gain Compression vs. Frequency,
 $I_d = 16 \text{ mA}$.

Figure 4. Noise Figure vs. Frequency,
 $I_d = 16 \text{ mA}$.

SOT-143 Package Dimensions



SYMBOL	DIMENSIONS (mm)	
	MIN.	MAX.
A	0.79	1.097
A1	0.013	0.10
B	0.36	0.54
B1	0.76	0.92
C	0.086	0.152
D	2.80	3.06
E1	1.20	1.40
e	0.89	1.02
e1	1.78	2.04
e2	0.45	0.60
E	2.10	2.65
L	0.45	0.69

Notes:

XXX-package marking
 Drawings are not to scale

www.agilent.com/semiconductors

For product information and a complete list of distributors, please go to our web site.

For technical assistance call:

Americas/Canada: +1 (800) 235-0312 or (916) 788-6763

Europe: +49 (0) 6441 92460

China: 10800 650 0017

Hong Kong: (65) 6756 2394

India, Australia, New Zealand: (65) 6755 1939

Japan: (+81 3) 3335-8152(Domestic/International), or 0120-61-1280(Domestic Only)

Korea: (65) 6755 1989

Singapore, Malaysia, Vietnam, Thailand, Philippines, Indonesia: (65) 6755 2044

Taiwan: (65) 6755 1843

Data subject to change.

Copyright © 2005 Agilent Technologies, Inc.

Obsoletes 5985-9584E

April 4, 2005

5989-2756EN



Agilent Technologies