

MSA-0436

Cascadable Silicon Bipolar MMIC Amplifiers



Data Sheet

Description

The MSA-0436 is a high performance silicon bipolar Monolithic Microwave Integrated Circuit (MMIC) housed in a cost effective, microstrip package. This MMIC is designed for use as a general purpose 50Ω gain block. Typical applications include narrow and broad band IF and RF amplifiers in industrial and military applications.

The MSA-series is fabricated using Avago's 10 GHz f_T , 25 GHz f_{MAX} , silicon bipolar MMIC process which uses nitride self-alignment, ion implantation, and gold metallization to achieve excellent performance, uniformity and reliability. The use of an external bias resistor for temperature and current stability also allows bias flexibility.

Features

- Cascadable 50Ω Gain Block
- 3 dB Bandwidth: DC to 3.8 GHz
- 12.5 dBm Typical P_{1dB} at 1.0 GHz
- 8.5 dB Typical Gain at 1.0 GHz
- Unconditionally Stable ($k > 1$)
- Cost Effective Ceramic Microstrip Package

36 micro-X Package

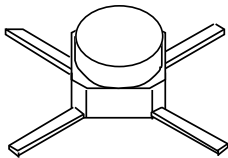

Typical Biasing Configuration

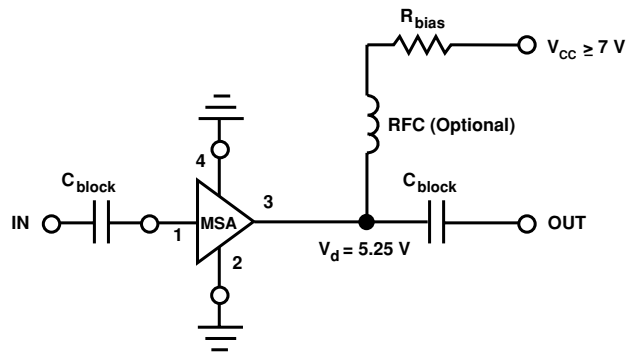

MSA-0436 Absolute Maximum Ratings

Parameter	Absolute Maximum ^[1]
Device Current	100 mA
Power Dissipation ^[2,3]	650 mW
RF Input Power	+13 dBm
Junction Temperature	150°C
Storage Temperature ^[4]	-65 to 150°C

Thermal Resistance^{[2,5]:}

$$\theta_{jc} = 140^{\circ}\text{C}/\text{W}$$

Notes:

1. Permanent damage may occur if any of these limits are exceeded.
2. $T_{\text{CASE}} = 25^{\circ}\text{C}$.
3. Derate at $7.1 \text{ mW}/^{\circ}\text{C}$ for $T_{\text{C}} > 109^{\circ}\text{C}$.
4. Storage above $+150^{\circ}\text{C}$ may tarnish the leads of this package making it difficult to solder into a circuit.
5. The small spot size of this technique results in a higher, though more accurate determination of q_{jc} than do alternate methods.

Electrical Specifications^[1], $T_{\text{A}} = 25^{\circ}\text{C}$

Symbol	Parameters and Test Conditions: $I_{\text{d}} = 50 \text{ mA}$, $Z_{\text{O}} = 50 \Omega$	Units	Min.	Typ.	Max.
G_{P}	Power Gain ($ S_{21} ^2$)	dB	7.5	8.5	9.5
ΔG_{P}	Gain Flatness	dB		± 0.6	± 1.0
$f_{\text{3 dB}}$	3 dB Bandwidth	GHz		3.8	
VSWR	Input VSWR			1.4:1	
	Output VSWR			1.9:1	
NF	50 Ω Noise Figure	dB		6.5	
$P_{1 \text{ dB}}$	Output Power at 1 dB Gain Compression	dBm		12.5	
IP_3	Third Order Intercept Point	dBm		25.5	
t_{D}	Group Delay	psec		125	
V_{d}	Device Voltage	V	4.75	5.25	5.75
dV/dT	Device Voltage Temperature Coefficient	mV/ $^{\circ}\text{C}$		-8.0	

Note:

1. The recommended operating current range for this device is 30 to 70 mA. Typical performance as a function of current is on the following page.

Ordering Information

Part Numbers	No. of Devices	Comments
MSA-0436-BLKG	100	Bulk
MSA-0436-TR1G	1000	7" Reel

MSA-0436 Typical Scattering Parameters ($Z_0 = 50 \Omega$, $T_A = 25^\circ\text{C}$, $I_d = 50 \text{ mA}$)

Freq. GHz	S_{11}		S_{21}			S_{12}			S_{22}	
	Mag	Ang	dB	Mag	Ang	dB	Mag	Ang	Mag	Ang
0.1	.08	175	8.5	2.67	175	-16.4	.151	1	.20	-10
0.2	.08	172	8.5	2.68	170	-16.3	.153	2	.20	-16
0.4	.07	171	8.5	2.67	161	-16.4	.151	3	.20	-33
0.6	.07	166	8.5	2.66	151	-16.2	.155	6	.21	-45
0.8	.05	169	8.4	2.64	142	-16.1	.156	8	.22	-57
1.0	.05	175	8.3	2.61	136	-16.0	.159	10	.24	-68
1.5	.04	-142	8.1	2.55	109	-15.0	.178	13	.26	-96
2.0	.09	-145	7.8	2.46	87	-14.2	.196	15	.28	-123
2.5	.14	-154	7.3	2.33	71	-13.1	.221	18	.31	-140
3.0	.22	-175	6.6	2.14	50	-12.5	.238	14	.33	-160
3.5	.28	170	5.8	1.94	32	-11.7	.260	9	.35	-173
4.0	.34	156	4.8	1.74	15	-11.3	.271	4	.34	-179
4.5	.37	140	3.9	1.57	-1	-10.7	.291	-2	.33	-171
5.0	.42	120	3.0	1.41	-16	-10.4	.302	-8	.32	-160

Typical Performance, $T_A = 25^\circ\text{C}$

(unless otherwise noted)

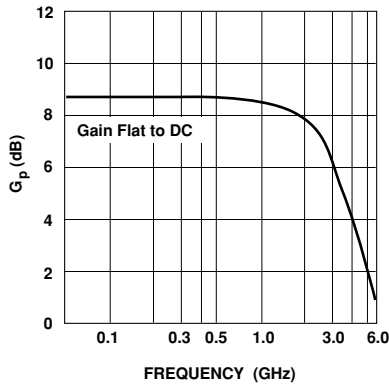
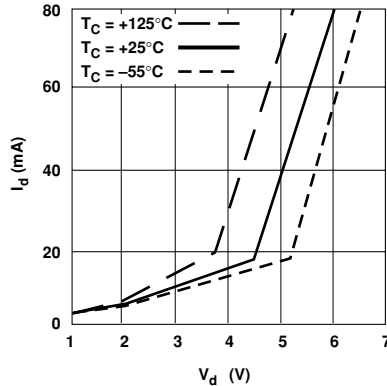
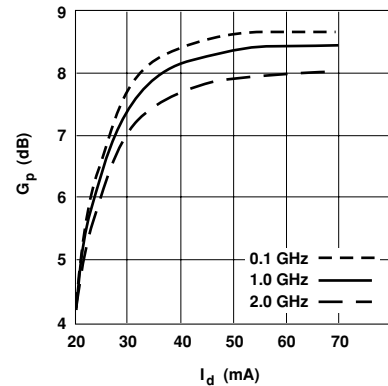
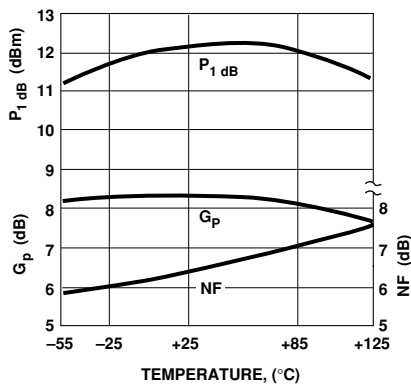
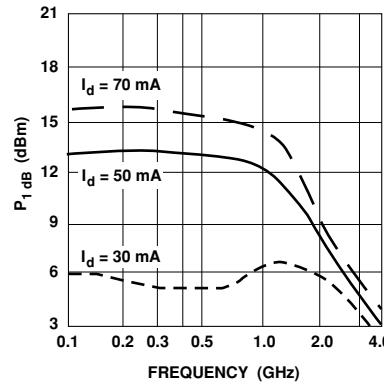
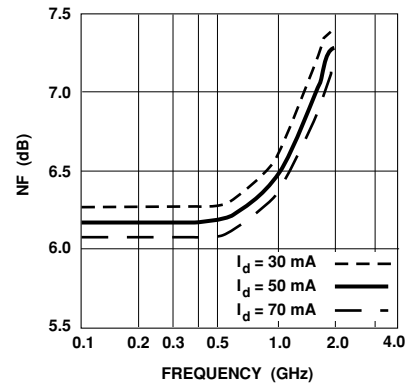
Figure 1. Typical Power Gain vs. Frequency, $T_A = 25^\circ\text{C}$, $I_d = 50 \text{ mA}$.

Figure 2. Device Current vs. Voltage.

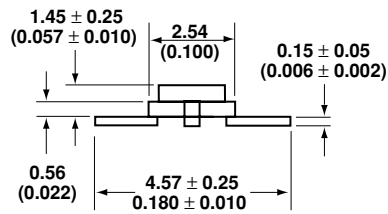
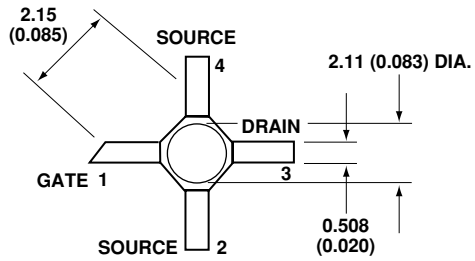
Figure 3. Power Gain vs. Current.

Figure 4. Output Power at 1 dB Gain Compression, NF and Power Gain vs. Case Temperature, $f = 1.0 \text{ GHz}$, $I_d = 50 \text{ mA}$.

Figure 5. Output Power at 1 dB Gain Compression vs. Frequency.

Figure 6. Noise Figure vs. Frequency.

36 micro-X Package Dimensions



Notes:

1. Dimensions are in millimeters (inches)
2. Tolerances: in .xxx = ± 0.005
mm .xx = ± 0.13

For product information and a complete list of distributors, please go to our web site: www.avagotech.com

Avago, Avago Technologies, and the A logo are trademarks of Avago Technologies, Limited in the United States and other countries. Data subject to change. Copyright © 2007 Avago Technologies, Limited. All rights reserved. Obsoletes 5989-2740EN AV02-0303EN - April 12, 2007

