

## Data Sheet

### Description

The MSA-0420 is a high performance silicon bipolar Monolithic Microwave Integrated Circuit (MMIC) housed in a hermetic, high reliability package. This MMIC is designed for use as a general purpose 50Ω gain block. Typical applications include narrow and broad band IF and RF amplifiers in industrial and military applications.

The MSA-series is fabricated using Avago's 10 GHz  $f_T$ , 25 GHz  $f_{MAX}$ , silicon bipolar MMIC process which uses nitride self-alignment, ion implantation, and gold metallization to achieve excellent performance, uniformity and reliability. The use of an external bias resistor for temperature and current stability also allows bias flexibility.

### Features

- Cascadable 50Ω Gain Block
- 3 dB Bandwidth: DC to 4.0 GHz
- 8.5 dB Typical Gain at 1.0 GHz
- 16.0 dBm Typical  $P_{1\text{ dB}}$  at 1.0 GHz
- Unconditionally Stable ( $k > 1$ )
- Hermetic Metal/Beryllia Microstrip Package

### 200 mil BeO Package

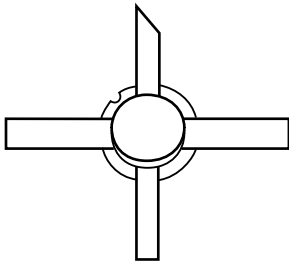

### Typical Biasing Configuration

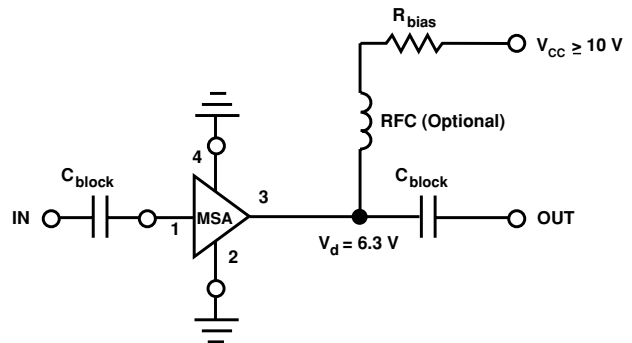

## MSA-0420 Absolute Maximum Ratings

Parameter	Absolute Maximum <sup>[1]</sup>
Device Current	120 mA
Power Dissipation <sup>[2,3]</sup>	850 mW
RF Input Power	+13 dBm
Junction Temperature	200°C
Storage Temperature	-65 to 200°C

Thermal Resistance<sup>[2,4]</sup>:

$$\theta_{jc} = 40^{\circ}\text{C/W}$$

Notes:

1. Permanent damage may occur if any of these limits are exceeded.
2.  $T_{\text{CASE}} = 25^{\circ}\text{C}$ .
3. Derate at 25 mW/°C for  $T_{\text{C}} > 166^{\circ}\text{C}$ .
4. The small spot size of this technique results in a higher, though more accurate determination of  $q_{jc}$  than do alternate methods.

## Electrical Specifications<sup>[1]</sup>, $T_{\text{A}} = 25^{\circ}\text{C}$

Symbol	Parameters and Test Conditions: $I_{\text{d}} = 90 \text{ mA}$ , $Z_0 = 50 \Omega$	Units	Min.	Typ.	Max.
$G_{\text{p}}$	Power Gain ( $ S_{21} ^2$ ) $f = 0.1 \text{ GHz}$	dB	7.5	8.5	9.5
$\Delta G_{\text{p}}$	Gain Flatness $f = 0.1 \text{ to } 2.5 \text{ GHz}$	dB		$\pm 0.6$	$\pm 1.0$
$f_{3 \text{ dB}}$	3 dB Bandwidth	GHz		4.3	
VSWR	Input VSWR $f = 0.1 \text{ to } 2.5 \text{ GHz}$			1.7:1	
	Output VSWR $f = 0.1 \text{ to } 2.5 \text{ GHz}$			1.8:1	
NF	50 $\Omega$ Noise Figure $f = 1.0 \text{ GHz}$	dB		6.5	
$P_{1 \text{ dB}}$	Output Power at 1 dB Gain Compression $f = 1.0 \text{ GHz}$	dBm	14.0	16.0	
$IP_3$	Third Order Intercept Point $f = 1.0 \text{ GHz}$	dBm		30.0	
$t_{\text{D}}$	Group Delay $f = 1.0 \text{ GHz}$	psec		140	
$V_{\text{d}}$	Device Voltage	V	5.7	6.3	6.9
$dV/dT$	Device Voltage Temperature Coefficient	mV/°C		-8.0	

Note:

1. The recommended operating current range for this device is 40 to 110 mA. Typical performance as a function of current is on the following page.

**MSA-0420 Typical Scattering Parameters** ( $Z_0 = 50 \Omega$ ,  $T_A = 25^\circ\text{C}$ ,  $I_d = 90 \text{ mA}$ )

Freq. GHz	$S_{11}$			$S_{21}$			$S_{12}$		$S_{22}$	
	Mag	Ang	dB	Mag	Ang	dB	Mag	Ang	Mag	Ang
0.1	.25	177	8.6	2.70	175	-16.4	.151	1	.03	-30
0.2	.25	173	8.6	2.69	170	-16.5	.150	1	.04	-59
0.4	.24	167	8.6	2.69	159	-16.5	.150	-1	.07	-79
0.6	.22	160	8.5	2.67	149	-16.4	.152	-2	.10	-92
0.8	.21	154	8.5	2.66	139	-16.3	.154	-2	.13	-99
1.0	.20	148	8.3	2.60	129	-16.1	.156	-3	.16	-109
1.5	.14	136	8.1	2.54	104	-15.6	.166	-4	.22	-124
2.0	.10	136	7.9	2.48	80	-14.8	.181	-6	.25	-139
2.5	.08	161	7.4	2.34	62	-14.3	.193	-5	.28	-147
3.0	.10	178	7.0	2.24	39	-13.7	.206	-11	.31	-157
3.5	.13	176	6.6	2.13	18	-12.6	.233	-18	.34	-167
4.0	.14	163	5.9	1.97	-3	-11.9	.253	-25	.36	-176
4.5	.14	133	5.3	1.83	-23	-11.3	.273	-33	.37	174
5.0	.16	91	4.5	1.69	-343	-10.5	.299	-43	.37	162

**Typical Performance,  $T_A = 25^\circ\text{C}$**

(unless otherwise noted)

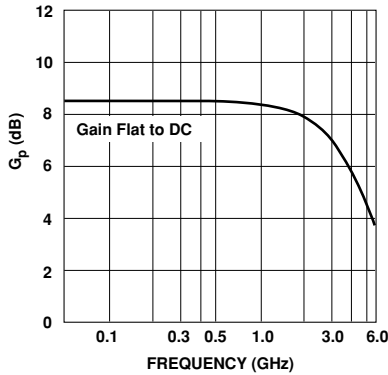

Figure 1. Typical Power Gain vs. Frequency,  $T_A = 25^\circ\text{C}$ ,  $I_d = 90 \text{ mA}$ .

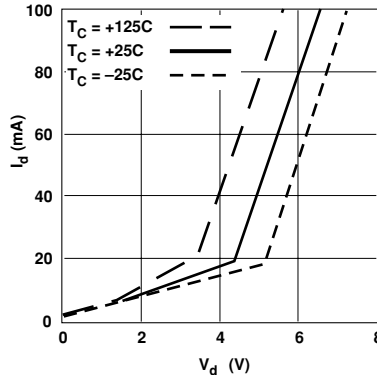

Figure 2. Device Current vs. Voltage.

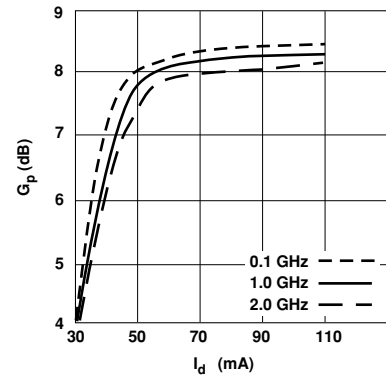

Figure 3. Power Gain vs. Current.

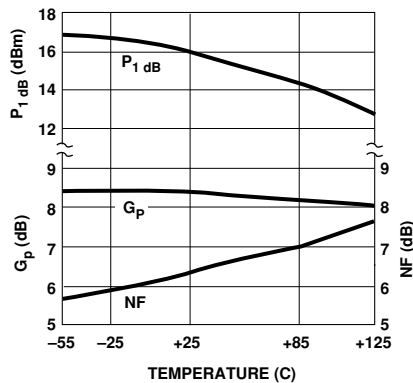

Figure 4. Output Power at 1 dB Gain Compression, NF and Power Gain vs. Case Temperature,  $f = 1.0 \text{ GHz}$ ,  $I_d = 90 \text{ mA}$ .

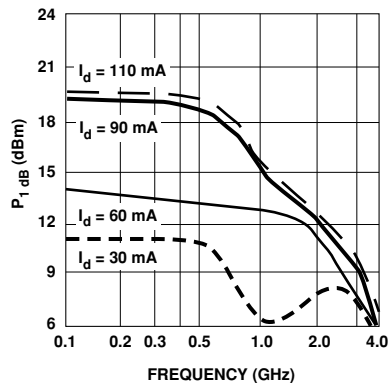

Figure 5. Output Power at 1 dB Gain Compression vs. Frequency.

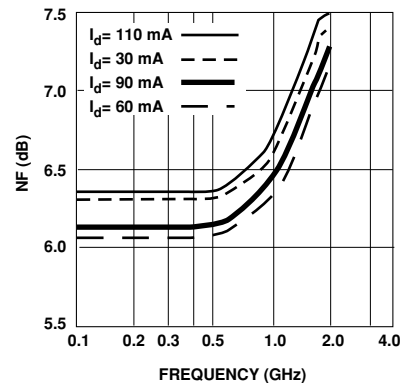
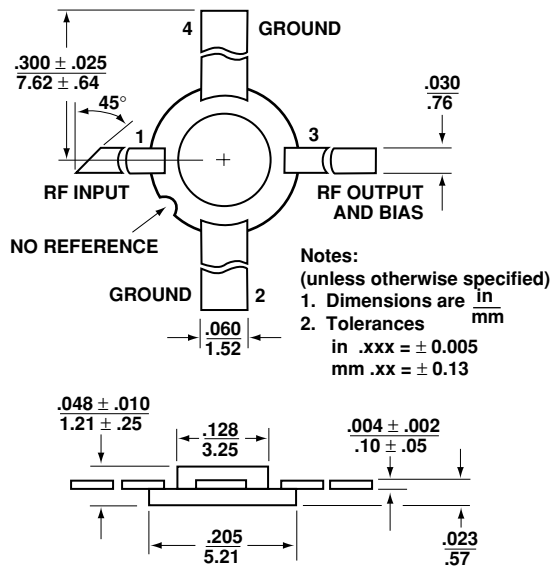

Figure 6. Noise Figure vs. Frequency.

## Ordering Information

Part Numbers	No. of Devices	Comments
MSA-0420	100	Bulk

## 200 mil BeO Package Dimensions



For product information and a complete list of distributors, please go to our web site: [www.avagotech.com](http://www.avagotech.com)

Avago, Avago Technologies, and the A logo are trademarks of Avago Technologies, Limited in the United States and other countries. Data subject to change. Copyright © 2008 Avago Technologies, Limited. All rights reserved. Obsoletes 5989-2752EN AV02-1225EN May 14, 2008

**AVAGO**  
TECHNOLOGIES