

# IAM - 93516

## High Linearity Integrated GaAs Mixer



## Data Sheet

### Description

Avago Technologies' IAM-93516 is a high linearity GaAs FET Mixer using 0.5μm enhancement mode pHEMT technology. This device houses in a 3x3 LPCC package. The IAM-93516 has a built-in LO buffer amplifier and an IF amplification stage that serve as an ideal solution for reducing board space and delivering excellent high IIP3, gain and isolation with a low LO drive power. The device is designed with a differential configuration to provide good noise immunity. The LO port is 50 ohm matched and can be driven differential or single ended. An interstage match is introduced between the mixer and amplifier stage to allow device tuning at the desired RF and LO frequency. The interstage match can be a simple low pass, high pass or intermediate frequency trap. The amplifier output port is 200 ohm matched and fully differential. The simple matching at the RF port provides for optimum input return loss, noise figure and IIP3 performance.

The IAM-93516 is ideally suited for frequency down conversion for base station radio card receiver, microwave link receiver, MMDS, modulation and demodulation for receiver and general purpose resistive FET mixer, which require high linearity. All devices are 100% RF and DC tested.

### Applications

- Frequency down converter for base station radio card, microwave link transceiver, and MMDS
- Modulation and demodulation for receiver
- General purpose resistive FET mixer for other high linearity applications

### Features

- DC = 5V @ 111mA (Typ.)
- RF = 1.91 GHz, Pin<sub>RF</sub> = -10 dBm;
- LO = 1.7 GHz, Pin<sub>LO</sub> = 0 dBm;
- IF = 210 MHz unless otherwise specified
- High Linearity: 23.1 dBm IIP3(typ)
- Conversion Gain: 9.4 dB typical
- Low Noise Figure: 11.6 dB
- Wide band operation:
- 400-3000 MHz RF & LO input
- 70 – 300 MHz IF output
- Fully differential or single ended operation
- High P1dB: 19.3 dB typical
- Consistent RF performance over LO Power
- Low current consumption: 5V@ 111mA typical
- Excellent uniformity in product specifications
- 3mm x 3mm x 0.9mm LPCC package
- MTTF > 300 years<sup>[1]</sup>
- MSL-1 and Lead-free.

## Pin Connections and Package Marking

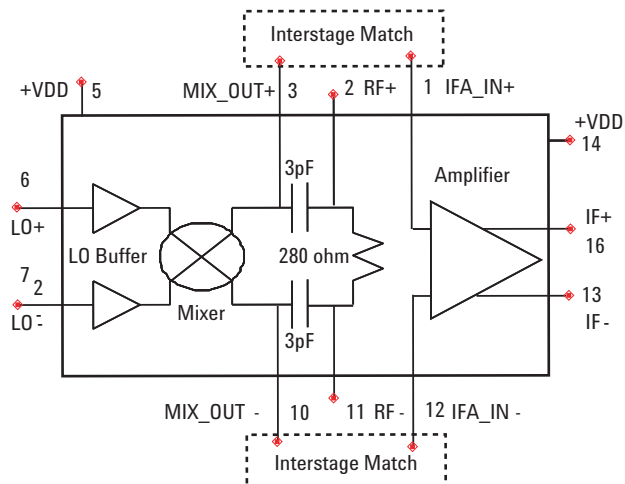
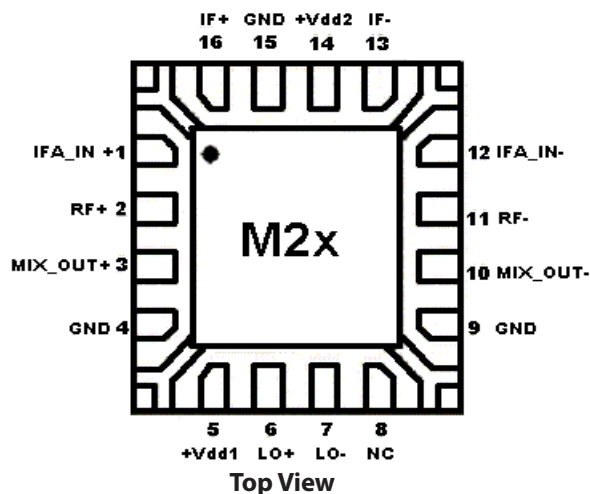

Note:

Package marking provides orientation and identification

"M2" = Device Code

"X" = Month code indicates the month of manufacture

## 1.0 Absolute Maximum Ratings [1]

Symbol	Parameter	Units	Absolute maximum
$V_D$	Supply Voltage [2]	V	7
$Pin_{RF}$	CW RF Input Power [2]	dBm	30
$Pin_{LO}$	CW LO Input Power [2]	dBm	18
$T_{CH}$	Channel Temperature	°C	150
$T_{STG}$	Storage Temperature	°C	-65 to 150
$q_{ch\_b}$	Thermal Resistance [4]	°C/W	39

Notes:

1. Operation of this device above any one of these parameters may cause permanent damage.
2. Determined at DC quiescent conditions and  $T_A = 25^\circ\text{C}$ .
3. Board (package belly) temperature  $T_B$  is  $25^\circ\text{C}$ . Derate  $25\text{ mW}/^\circ\text{C}$  for  $T_B > 130^\circ\text{C}$ .
4. Channel-to-board thermal resistance measured using Infra Red Imaging Method and  $150^\circ\text{C}$  Liquid Crystal Measurement method.

## 2.0 Product Consistency Distribution Charts [5,6]

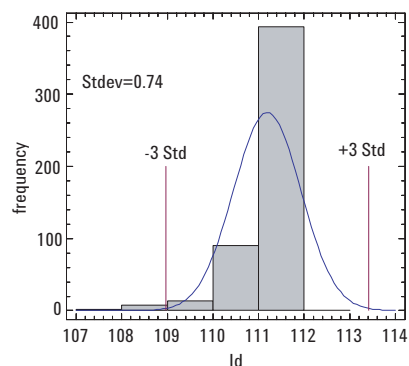

Figure 1. ID (mA) [7] Nominal = 111.2mA

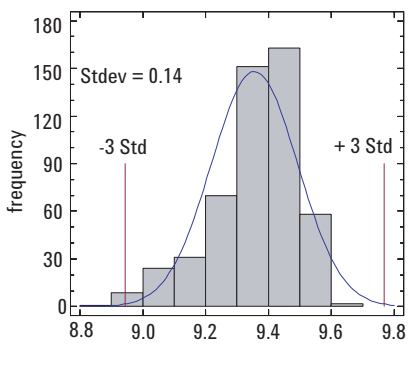

Figure 2. GAIN (dB) [8] Nominal = 9.4dB

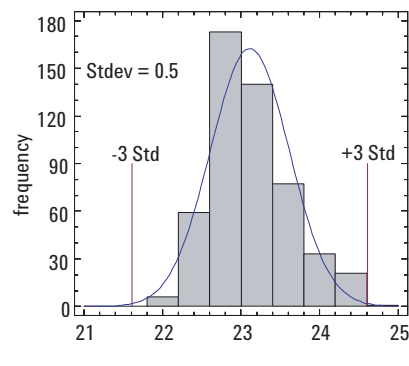

Figure 3. IIP3 (dBm) [8] Nominal = 23.1dBm

### 3.0 IAM-93516 Electrical Specifications<sup>[6,8]</sup>

$T_A = 25^\circ\text{C}$ , DC = 5V, RF Freq = 1.91GHz,  $\text{Pin}_{\text{RF}} = -10\text{dBm}$ , LO Freq = 1.7GHz,  $\text{Pin}_{\text{LO}} = 0\text{dBm}$  (unless otherwise specified)

Symbol	Parameter and Test Condition	Units	Min.	Typ	Max.
$I_d$ [7]	Device Current	mA	95.0	111.2	125.0
$G_C$	Conversion Gain	dB	7.9	9.4	10.9
IIP3 [8]	Output Third Order Intercept Point	dBm	20.5	23.1	-
NF	SSB Noise Figure	dB	-	11.6	-
P1dB	Output Power at 1dB Gain Compression	dBm	-	19.3	-
$RL_{\text{RF}}$	RF Port Return Loss	dB	-	12.0	-
$RL_{\text{LO}}$	LO Port Return Loss	dB	-	20.0	-
$RL_{\text{IF}}$	IF Port Return Loss	dB	-	11.0	-
$\text{ISOL}_{\text{L-R}}$	LO-RF Isolation	dB	-	26.0	-
$\text{ISOL}_{\text{L-I}}$	LO-IF Isolation	dB	-	20.0	-
$\text{ISOL}_{\text{R-L}}$	RF-IF Isolation	dB	-	32.0	-

Notes:

- Distribution data sample size is 510 samples taken from 3 different wafers lots. Future wafers allocated to this product may have nominal values anywhere between the upper and lower limits.
- Measurements were made on a production test board, which represents a trade-off between optimal Gain, IIP3, NF, P1dB and isolation. Board losses of 0.1dB at the RF input and IF amplifier output have been compensated. Balun loss of 0.57dB which was obtained from the Toko's supplied s-parameter file is also compensated. The total IF amplifier output loss is 0.67dB.
- The device current is measured without LO signal. At  $\text{LO}=0\text{dBm}$ , the current reduces by around 6 to 7mA.
- Gain, P1dB, isolation and return loss test conditions:  $F_{\text{RF}} = 1.91\text{GHz}$ ,  $F_{\text{LO}} = 1.7\text{GHz}$ ,  $F_{\text{IF}} = 210\text{MHz}$ ,  $\text{Pin}_{\text{RF}} = -10\text{dBm}$ ,  $\text{Pin}_{\text{LO}} = 0\text{dBm}$ .  
IIP3 test condition:  $F_{\text{RF}1} = 1.91\text{GHz}$ ,  $F_{\text{RF}2} = 1.89\text{GHz}$ ,  $F_{\text{LO}} = 1.7\text{GHz}$ ,  $\text{Pin}_{\text{RF}} = -10\text{dBm}$ ,  $\text{Pin}_{\text{LO}} = 0\text{dBm}$ .

### 4.0 IAM-93516 Typical Performance<sup>[9,10]</sup>

$T_A = 25^\circ\text{C}$ , DC = 5V, RF Freq = 1.91GHz,  $\text{Pin}_{\text{RF}} = -10\text{dBm}$ , LO Freq = 1.7GHz (unless otherwise specified)

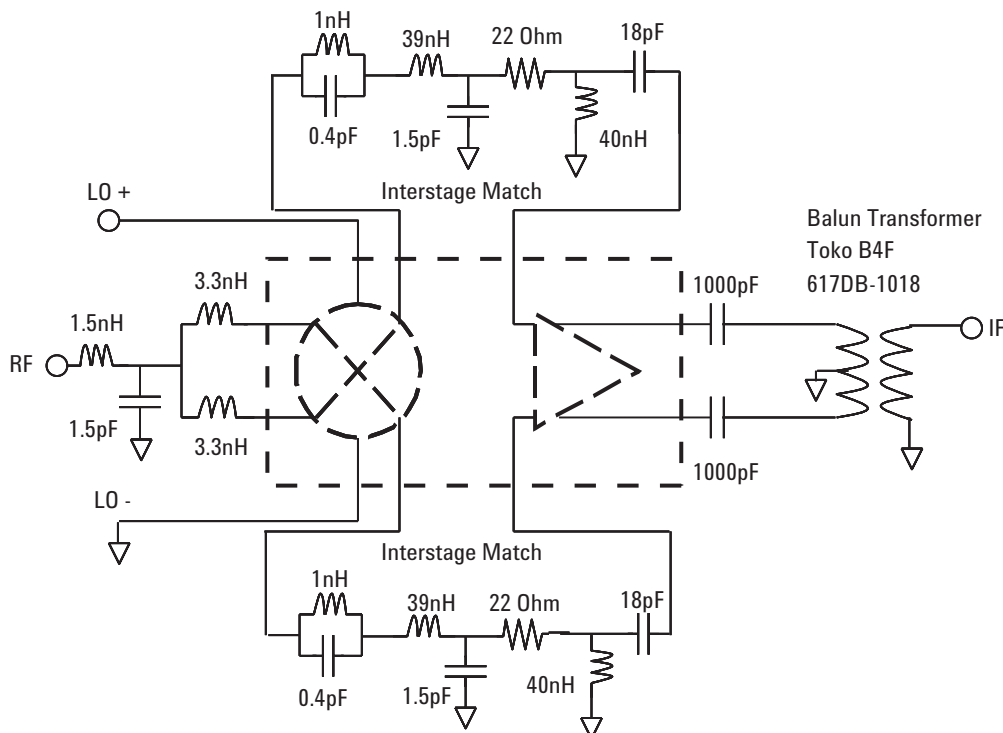

Figure 4. IAM-93516 demoboard schematic optimally tuned at  $F_{\text{RF}} = 1.91\text{GHz}$  and  $F_{\text{LO}} = 1.7\text{GHz}$

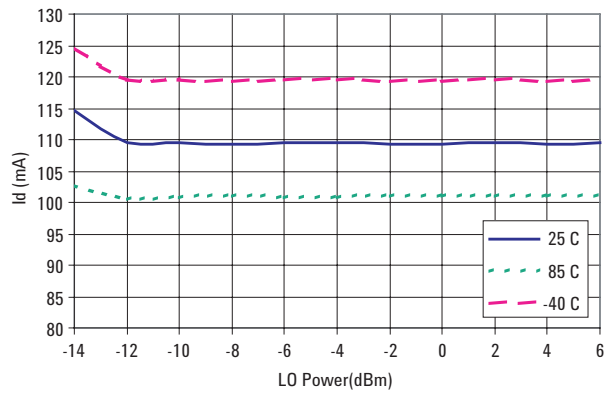

Figure 5. Current vs. LO Power and Temperature

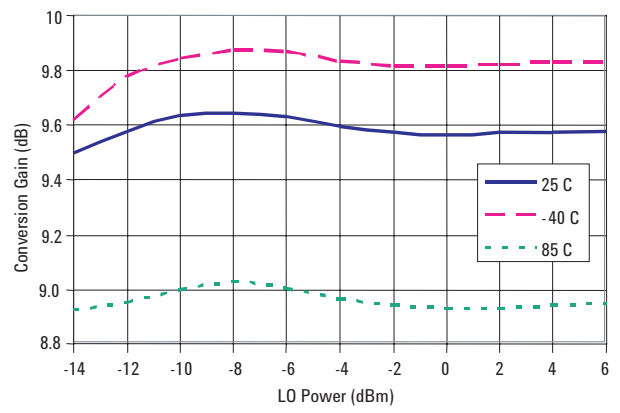

Figure 6. Conversion Gain vs. LO Power and Temperature

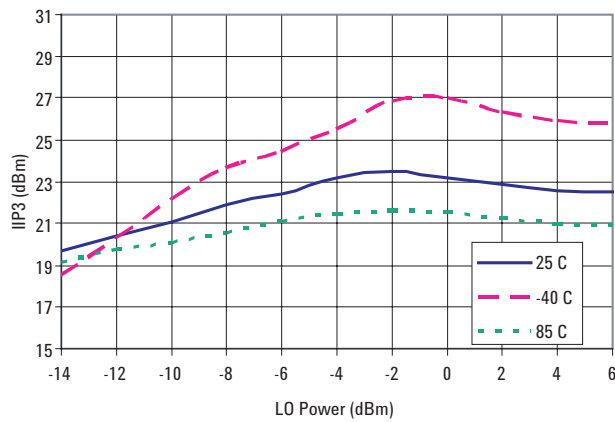

Figure 7. IIP3 vs. LO Power and Temperature

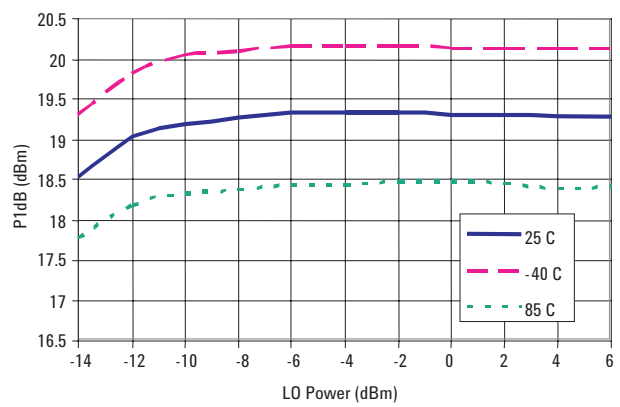

Figure 8. P1dB vs. LO Power and Temperature

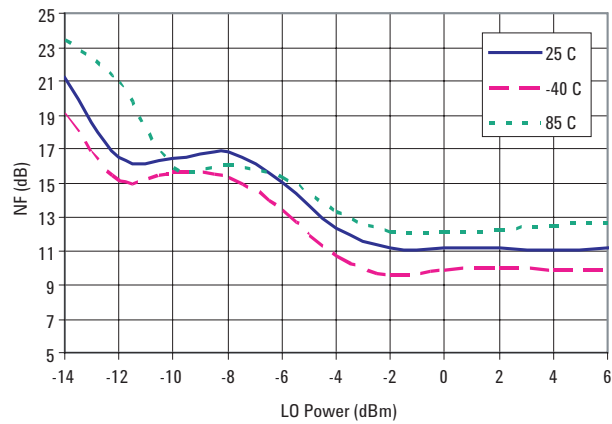

Figure 9. Noise Figure vs. LO Power and Temperature

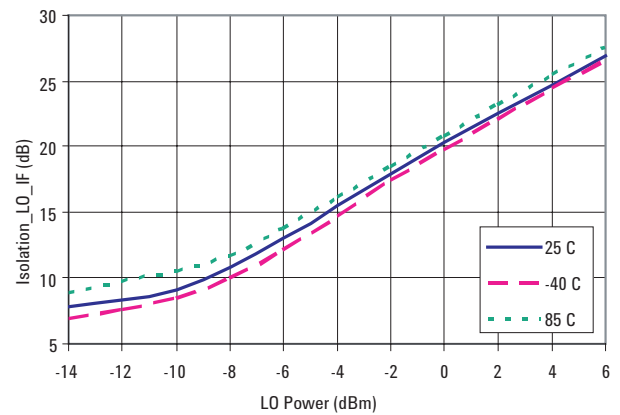

Figure 10. LO-IF Isolation vs. LO Power and Temperature

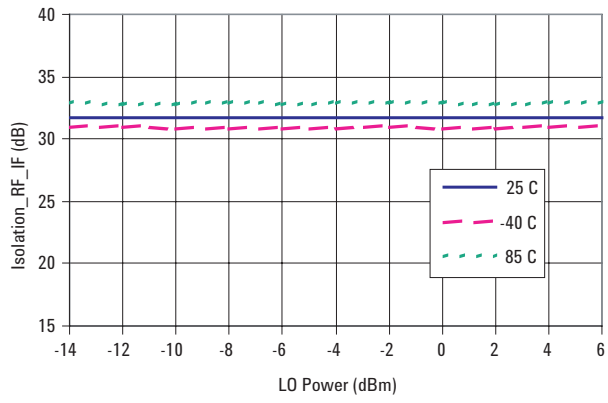

Figure 11. RF-IF Isolation vs. LO Power and Temperature

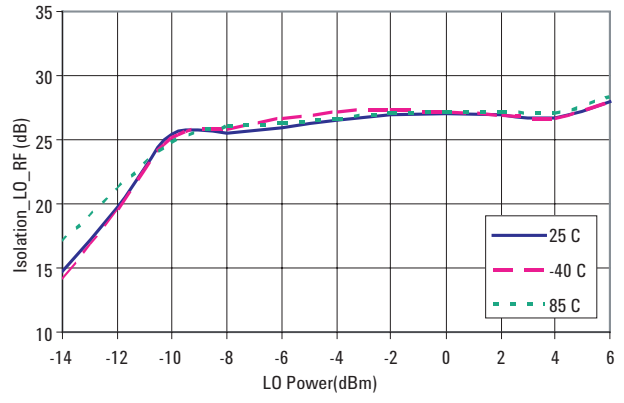

Figure 12. LO-RF Isolation vs. LO Power and Temperature

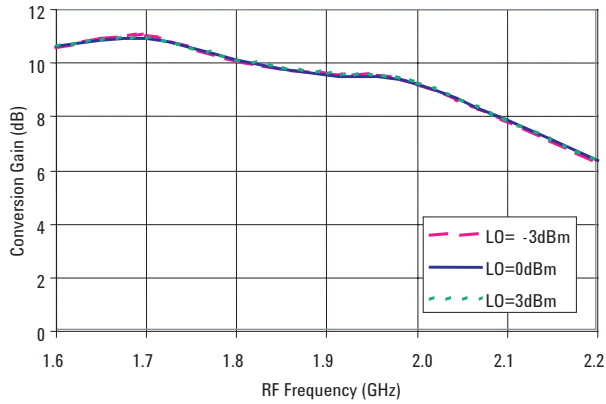

Figure 13. Conversion Gain vs. RF Frequency and LO Power at fixed IF frequency<sup>[11]</sup>

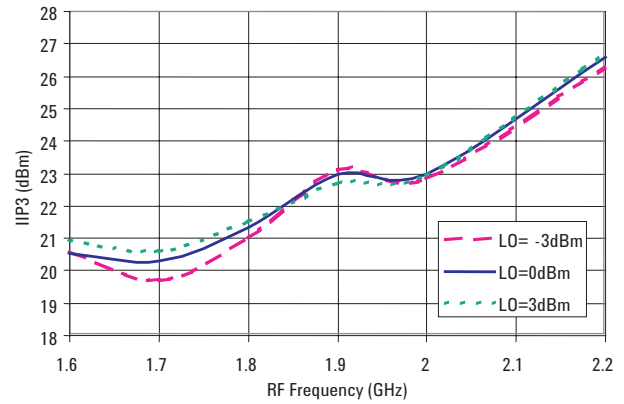

Figure 14. IIP3 vs. RF Frequency and LO Power at fixed IF frequency<sup>[11]</sup>

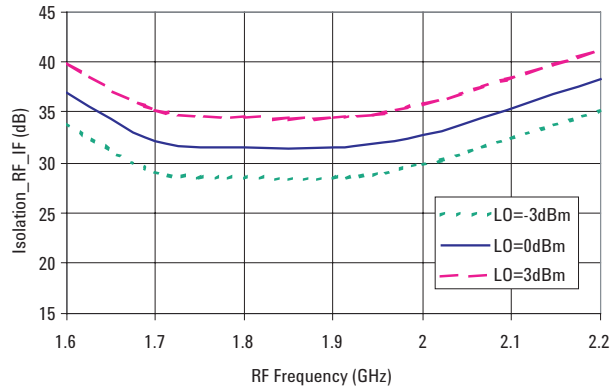

Figure 15. RF-IF Isolation vs. RF Frequency and LO Power at fixed IF frequency

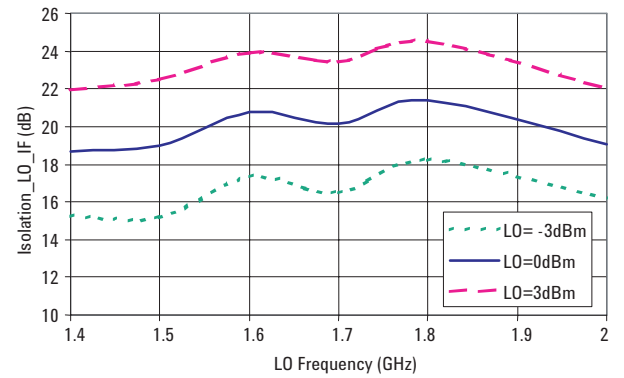
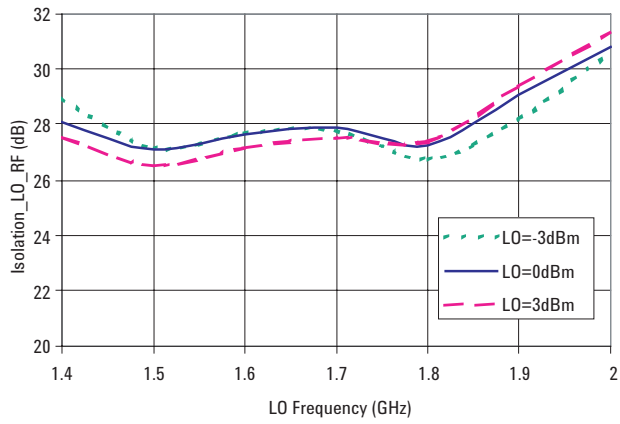
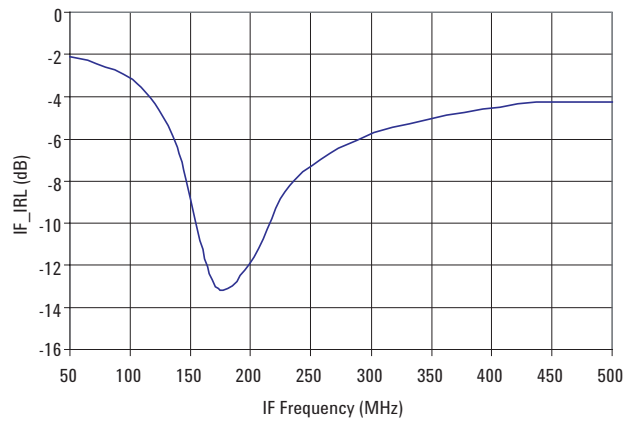

Figure 16. LO-IF Isolation vs. LO Frequency and LO Power at fixed IF frequency



**Figure 17. LO-RF Isolation vs. LO Frequency and LO Power at fixed IF frequency**



**Figure 18. IF Return Loss vs. IF Frequency**

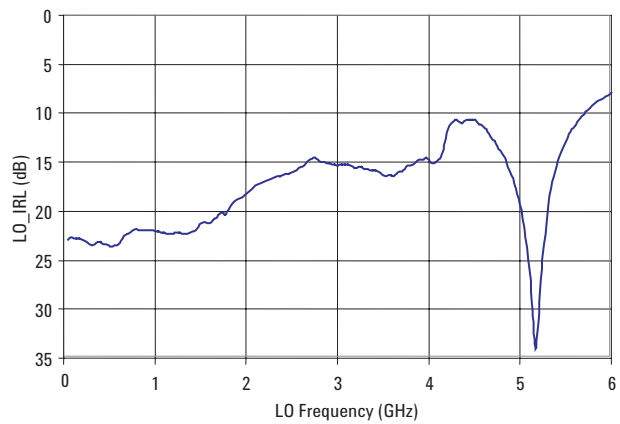

**Figure 19. LO Return Loss vs. LO Frequency**

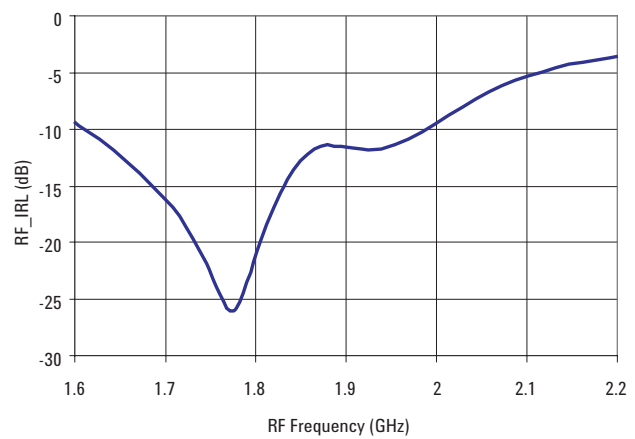

**Figure 20. RF Return Loss vs. RF Frequency**

**Notes:**

- 9. Results shown are based on Figure 4, which is optimally tuned for optimum conversion loss, IIP3, isolation and noise figure.
- 10. Balun loss of 0.57 dB @ 210 MHz have been deembedded into the IF Amplifier loss.
- 11. LO is low side injected for 210MHz IF frequency.

## 5.0 IAM-93516 Typical Harmonic Suppression Table<sup>[12,13]</sup>

		LO Harmonics					
		0	1	2	3	4	5
RF Harmonics	0		0.00	28.30	5.59	21.33	32.02
	1	39.96	0.00	57.37	52.89	53.95	59.01
	2	79.46	80.38	52.71	79.39	>90	87.51
	3	>90	>90	>90	83.75	>90	>90
	4	>90	>90	>90	>90	>90	>90
	5	>90	>90	>90	>90	>90	>90

**Figure 21. Harmonic Suppression Table**

Notes:

12. The harmonic suppression table shows the spurious signals present due to the mixing of the RF and LO at down conversion mode.

13. Test conditions

- a. RF = 1.91GHz @ -10dBm
- b. LO = 1.7GHz @ 0 dBm
- c. RF and LO Intermodulation Harmonics are referenced to the signal level produced by the down converted IF signal at 210MHz at the IF amplifier output
- d. LO Harmonics are referenced to the signal level of the LO signal at 1.7GHz at the IF amplifier output.

## 6.0 IAM-93516 Pin Description

Pin	Name	Description
1, 12	IFA_IN+ / IFA_IN-	IF Amplifier inputs. This is the signal output from the Mixer/IF Amplifier interstage match. (See product application note)
2, 11	RF+ / RF-	RF differential signal input. Simple matching is required for good RF return loss. (See product application note)
3, 10	MIX_OUT+ / MIX_OUT-	Signal at mixer output. This signal will be fed into the Mixer/IF Amplifier interstage match. (See product application note)
4, 9, 15	GND	Ground connection. For normal operation, all electrical grounds must be connected together.
5	VDD1	DC Power supply for the mixer circuit.
6, 7	LO+ / LO-	50 Ohm Local oscillator input. The local oscillator can be driven differential or single ended.
8	NC	No contact.
13, 16	IF + / IF-	200 Ohm differential amplifier output. A 4:1 balun is required to convert the differential output to single ended. (See product application note)
14	VDD2	DC Power supply for the IF amplifier circuit.

## PCB layout and Stencil Design

### LPCC 3x3 Package Dimensions

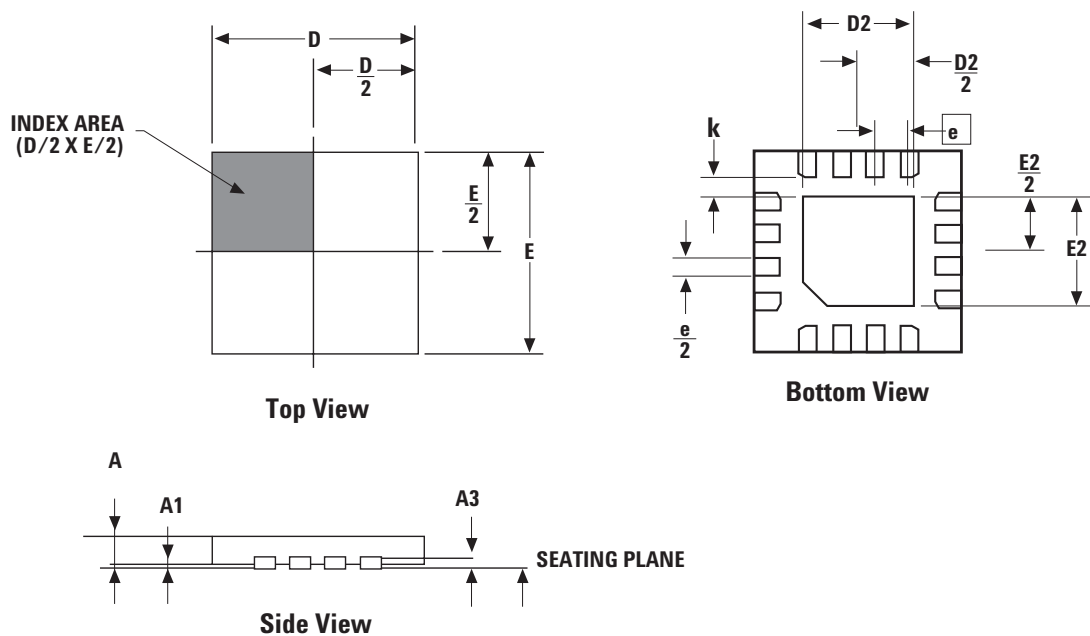

PACKAGE	1GL 3X3-0.50		
REF.	MIN.	NOM.	MAX.
A	0.80	0.90	1.00
D	2.90	3.00	3.10
D2	1.70	1.80	1.90
E	2.90	3.00	3.10
E2	1.70	1.80	1.90
e		0.50 BSC.	
A1	0	0.02	0.05
A3		0.20 REF.	
k	0.20		

**DIMENSIONS ARE IN MILLIMETERS**



## Device Orientation

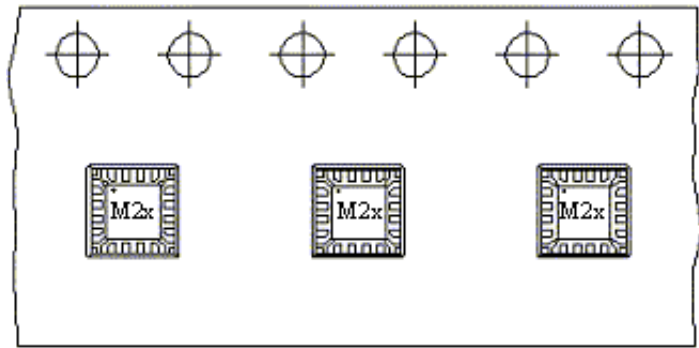
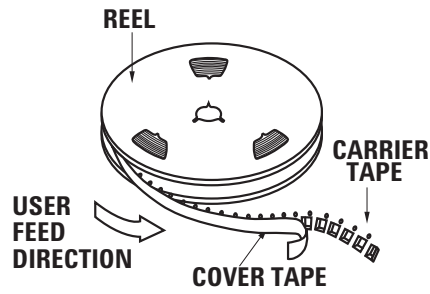

## Tape Dimensions

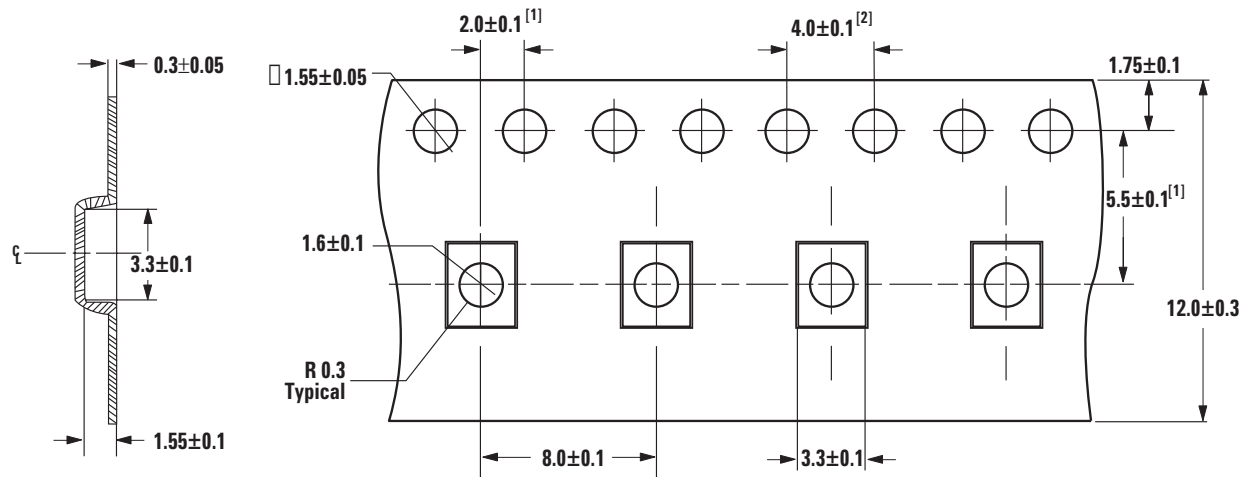

### Note:

- I. Measured from centerline of sprocket hole to centerline of pocket.
- II. Cumulative tolerance of 10 sprocket hole is  $\pm 0.20$ .
- III. Measured from centerline of sprocket hole to centerline of pocket.
- IV. Other material available.
- V. All dimension in millimeter unless otherwise stated.

## Part Number Ordering Information

Part Number	No. Of Devices	Container
IAM-93516-TR1	1000	7" Reel
IAM-93516-TR2	5000	13" Reel
IAM-93516-BLK	100	Antistatic Bag

For product information and a complete list of distributors, please go to our web site: [www.avagotech.com](http://www.avagotech.com)

Avago, Avago Technologies, and the A logo are trademarks of Avago Technologies, Pte. in the United States and other countries.

Data subject to change. Copyright © 2006 Avago Technologies Pte. All rights reserved.

5989-2800EN - March 29, 2006

