

# HLMP-HD61, HLMP-HM61 and HLMP-HB61

## Precision Optical Performance Red, Green and Blue

### 5mm Standard Oval LEDs



## Data Sheet



### Description

These Precision Optical Performance Oval LEDs are specifically designed for full color/video and passenger information signs. The oval shaped radiation pattern and high luminous intensity ensure that these devices are excellent for wide field of view outdoor applications where a wide viewing angle and readability in sunlight are essential. These lamps have very smooth, matched radiation patterns ensuring consistent color mixing in full color applications, message uniformity across the viewing angle of the sign. High efficiency LED material is used in these lamps: Aluminum Indium Gallium Phosphide (AlInGaP II) for red and Indium Gallium Nitride for blue and green. Each lamp is made with an advanced optical grade epoxy offering superior high temperature and high moisture resistance in outdoor applications.

The package epoxy contains both UV-A and UV-B inhibitors to reduce the effects of long term exposure to direct sunlight.

### Package Dimensions

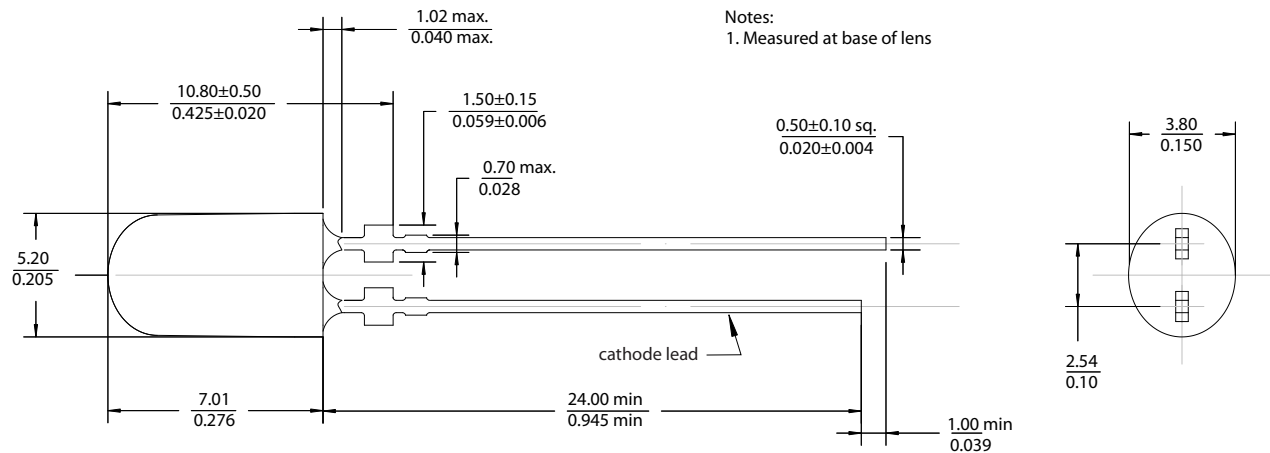

Notes:  
1. Measured at base of lens

Notes:  
All dimensions in millimeters (inches).  
For Blue and Green if heat-sinking application is required, the terminal for heat sink is anode.

### Features

- Well defined spatial radiation pattern
- High brightness material
- Available in red, green and blue color.
  - Red AlInGaP 630nm
  - Green InGaN 525nm
  - Blue InGaN 470nm
- Superior resistance to moisture
- Standoff package
- Tinted and diffused

### Applications

- Full color signs
- Commercial outdoor advertising.

*Caution: InGaN devices are Class 1C HBM ESD Sensitive per JEDEC Standard. Please observe appropriate precautions during handling and processing. Refer to Application Note AN-1142 for additional details.*

## Device Selection Guide

Part Number	Color and Dominant Wavelength $\lambda_d$ (nm) Typ	Luminous Intensity $I_v$ (mcd) at 20 mA Min	Luminous Intensity $I_v$ (mcd) at 20 mA Max
HLMP-HD61-TXTZZ	Red 630	800	1990
HLMP-HM61-Y30ZZ	Green 525	1990	5040
HLMP-HB61-QU0ZZ	Blue 470	460	1150

Tolerance for each intensity limit is  $\pm 15\%$ .

Notes:

1. The luminous intensity is measured on the mechanical axis of the lamp package.

## Part Numbering System

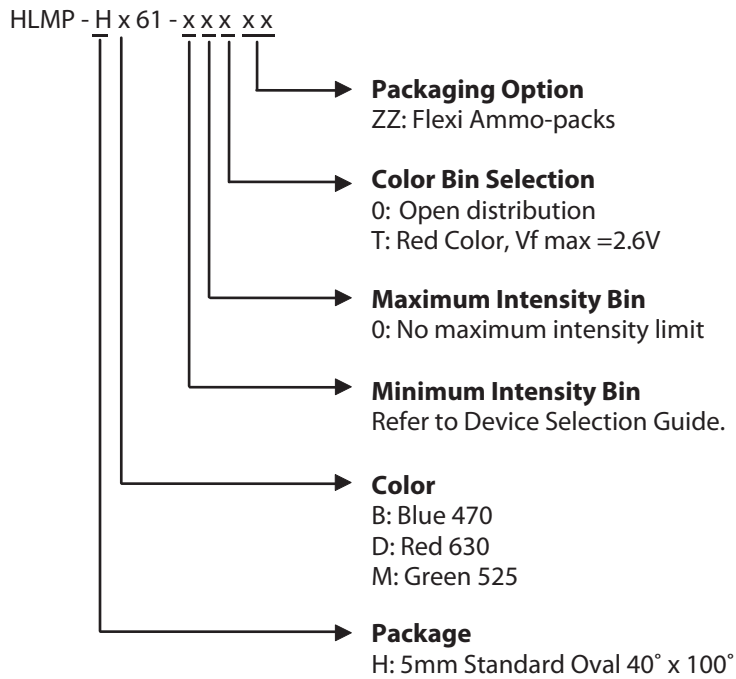

Please refer to AB 5337 for complete information about part numbering system.

## Absolute Maximum Rating ( $T_A = 25^\circ\text{C}$ )

Parameter	Red	Blue and Green	Unit
DC Forward Current <sup>[1]</sup>	50	30	mA
Peak Forward Current	100 <sup>[2]</sup>	100 <sup>[3]</sup>	mA
Power Dissipation	130	116	mW
Reverse Voltage	5 ( $I_R = 100 \mu\text{A}$ )	5 ( $I_R = 10 \mu\text{A}$ )	V
LED Junction Temperature	130	110	°C
Operating Temperature Range	-40 to +100	-40 to +85	°C
Storage Temperature Range	-40 to +100	-40 to +100	°C

Notes:

1. Derate linearly as shown in Figure 2 and Figure 8.
2. Duty Factor 30%, frequency 1KHz.
3. Duty Factor 10%, frequency 1KHz.

## Electrical / Optical Characteristics (T<sub>A</sub> = 25°C)

Parameter	Symbol	Min.	Typ.	Max.	Units	Test Conditions
Forward Voltage	V <sub>F</sub>				V	I <sub>F</sub> = 20 mA
Red		2.0	2.3	2.6 <sup>[1]</sup>		
Green		2.8	3.3	3.8		
Blue		2.8	3.2	3.8		
Reverse Voltage	V <sub>R</sub>				V	
Red		5				I <sub>R</sub> = 100 μA
Green & blue		5				I <sub>R</sub> = 10 μA
Dominant Wavelength <sup>[2]</sup>	λ <sub>D</sub>					I <sub>F</sub> = 20 mA
Red		622	630	634	nm	
Green		520	525	540		
Blue		460	470	480		
Peak Wavelength	λ <sub>PEAK</sub>					
Red			639		nm	Peak of Wavelength of Spectral Distribution at I <sub>F</sub> = 20 mA
Green			516			
Blue			464			
Spectral Half width	Δλ <sub>1/2</sub>					
Red			17		nm	Wavelength Width at Spectral Distribution ½ Power Point at I <sub>F</sub> = 20 mA
Green			32			
Blue			23			
Thermal Resistance <sup>[3]</sup>	Rθ <sub>J-PIN</sub>		240		°C/W	LED Junction-to-pin
Luminous Efficacy <sup>[4]</sup>	η <sub>V</sub>					
Red			155		lm/W	Emitted Luminous Power/Emitted Radiant Power
Green			520			
Blue			75			
Luminous Flux	φ <sub>V</sub>					
Red			1300		mlm	I <sub>F</sub> = 20 mA
Green			3000			
Blue			600			
Luminous Efficiency <sup>[5]</sup>	η <sub>e</sub>					
Red			30		lm/W	Luminous Flux/Electrical Power I <sub>F</sub> = 20 mA
Green			50			
Blue			10			

### Notes:

- For option -xxTxx, the VF maximum is 2.6V, refer to Vf bin table
- The dominant wavelength is derived from the chromaticity Diagram and represents the color of the lamp
- For AlInGaP Red, thermal resistance applied to LED junction to cathode lead. For InGaN blue and Green, thermal resistance applied to LED junction to anode lead.
- The radiant intensity, I<sub>e</sub> in watts per steradian, may be found from the equation I<sub>e</sub> = I<sub>v</sub>/η<sub>V</sub> where I<sub>v</sub> is the luminous intensity in candelas and η<sub>V</sub> is the luminous efficacy in lumens/watt.
- η<sub>e</sub> = φ<sub>V</sub> / I<sub>F</sub> × V<sub>F</sub>, where φ<sub>V</sub> is the emitted luminous flux, I<sub>F</sub> is electrical forward current and V<sub>F</sub> is the forward voltage.
- Forward voltage allowable tolerance is ± 0.05V.

## AllnGaP Red

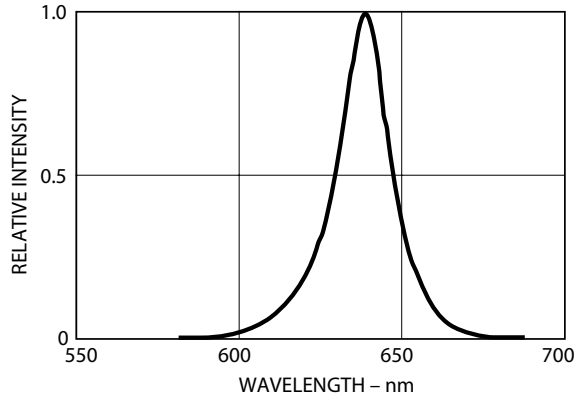

Figure 1. Relative Intensity vs Wavelength

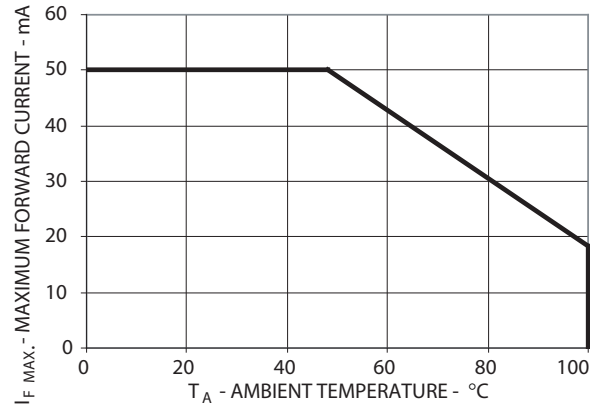

Figure 2. Maximum Forward Current vs Ambient Temperature

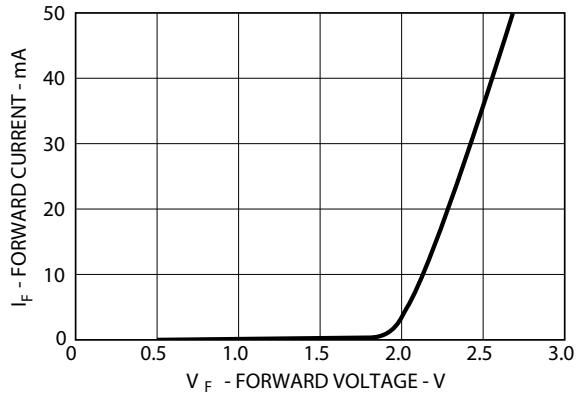

Figure 3. Forward Current vs Forward Voltage

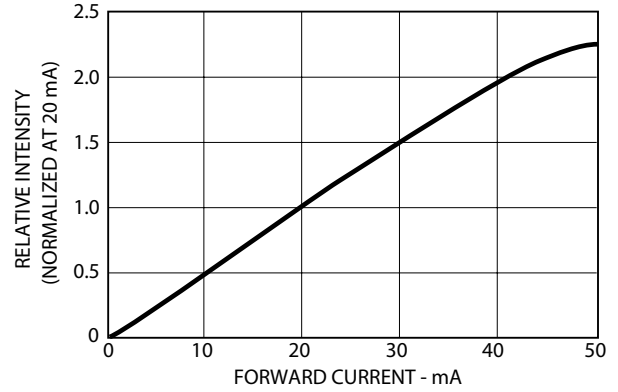

Figure 4. Relative Intensity vs Forward Current

## InGaN Blue and Green

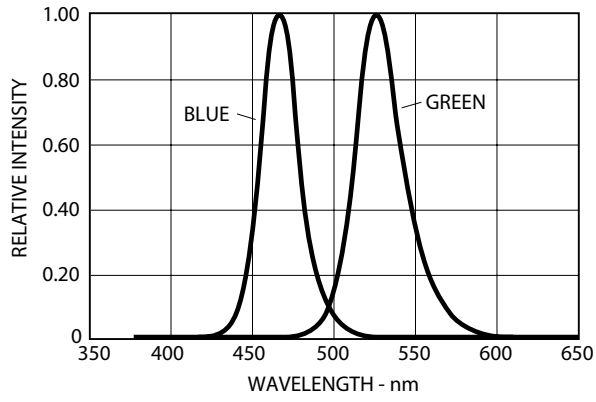

Figure 5. Relative Intensity vs Wavelength

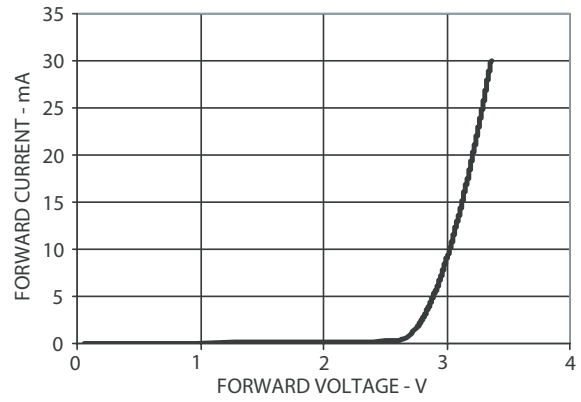

Figure 6. Forward Current vs Forward Voltage

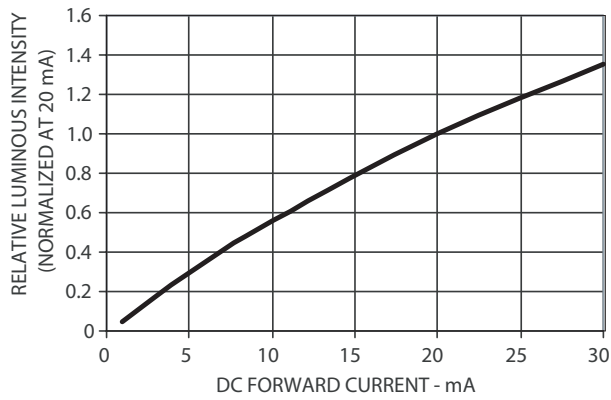

Figure 7. Relative Intensity vs Forward Current

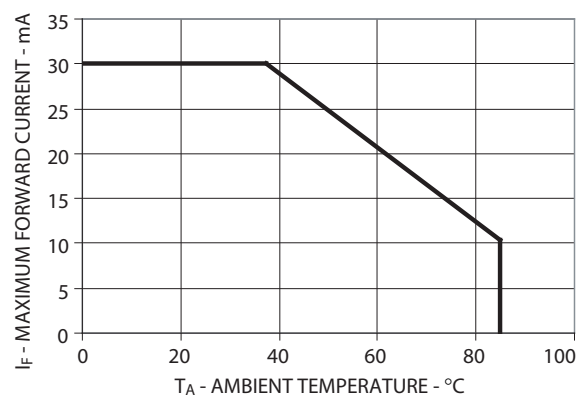
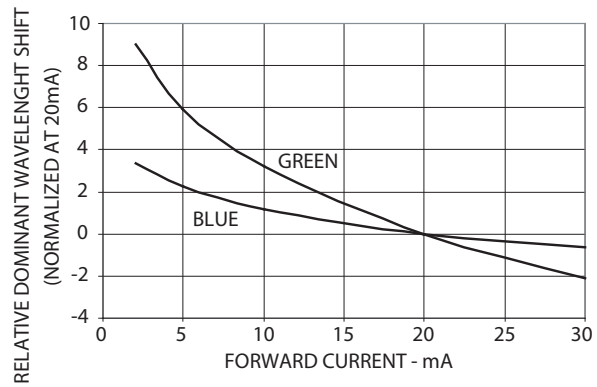
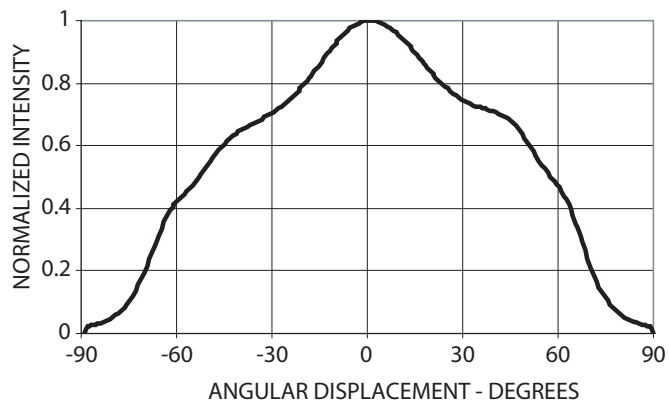

Figure 8. Maximum Forward Current vs Ambient Temperature



**Figure 9. Relative dominant wavelength vs Forward Current**



**Figure 10. Radiation pattern-Major Axis**

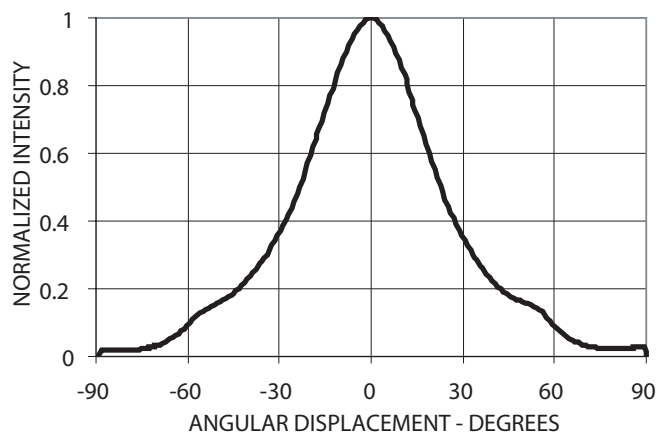

**Figure 11. Radiation pattern-Minor Axis**

### Intensity Bin Limit Table (1.2: 1 Iv Bin Ratio)

Bin	Intensity (mcd) at 20 mA	
	Min	Max
Q	460	550
R	550	660
S	660	800
T	800	960
U	960	1150
V	1150	1380
W	1380	1660
X	1660	1990
Y	1990	2400
Z	2400	2900
1	2900	3500
2	3500	4200
3	4200	5040

Tolerance for each bin limit is  $\pm 15\%$

### VF bin Table (V at 20mA)

Bin ID	Min.	Max.
VA	2.0	2.2
VB	2.2	2.4
VC	2.4	2.6

Tolerance for each bin limit is  $\pm 0.05$

### Red Color Range

Min Dom	Max Dom	Xmin	Ymin	Xmax	Ymax
622	634	0.6904	0.3094	0.6945	0.2888
		0.6726	0.3106	0.7135	0.2865

Tolerance for each bin limit is  $\pm 0.5$  nm

### Green Color Bin Table

Bin	Min Dom	Max Dom	Xmin	Ymin	Xmax	Ymax
1	520.0	524.0	0.0743	0.8338	0.1856	0.6556
			0.1650	0.6586	0.1060	0.8292
2	524.0	528.0	0.1060	0.8292	0.2068	0.6463
			0.1856	0.6556	0.1387	0.8148
3	528.0	532.0	0.1387	0.8148	0.2273	0.6344
			0.2068	0.6463	0.1702	0.7965
4	532.0	536.0	0.1702	0.7965	0.2469	0.6213
			0.2273	0.6344	0.2003	0.7764
5	536.0	540.0	0.2003	0.7764	0.2659	0.6070
			0.2469	0.6213	0.2296	0.7543

Tolerance for each bin limit is  $\pm 0.5$ nm

### Blue Color Bin Table

Bin	Min Dom	Max Dom	Xmin	Ymin	Xmax	Ymax
1	460.0	464.0	0.1440	0.0297	0.1766	0.0966
			0.1818	0.0904	0.1374	0.0374
2	464.0	468.0	0.1374	0.0374	0.1699	0.1062
			0.1766	0.0966	0.1291	0.0495
3	468.0	472.0	0.1291	0.0495	0.1616	0.1209
			0.1699	0.1062	0.1187	0.0671
4	472.0	476.0	0.1187	0.0671	0.1517	0.1423
			0.1616	0.1209	0.1063	0.0945
5	476.0	480.0	0.1063	0.0945	0.1397	0.1728
			0.1517	0.1423	0.0913	0.1327

Tolerance for each bin limit is  $\pm 0.5$ nm

Note:

- All bin categories are established for classification of products. Products may not be available in all bin categories. Please contact your Avago representative for further information.

### Avago Color Bin on CIE 1931 Chromaticity Diagram

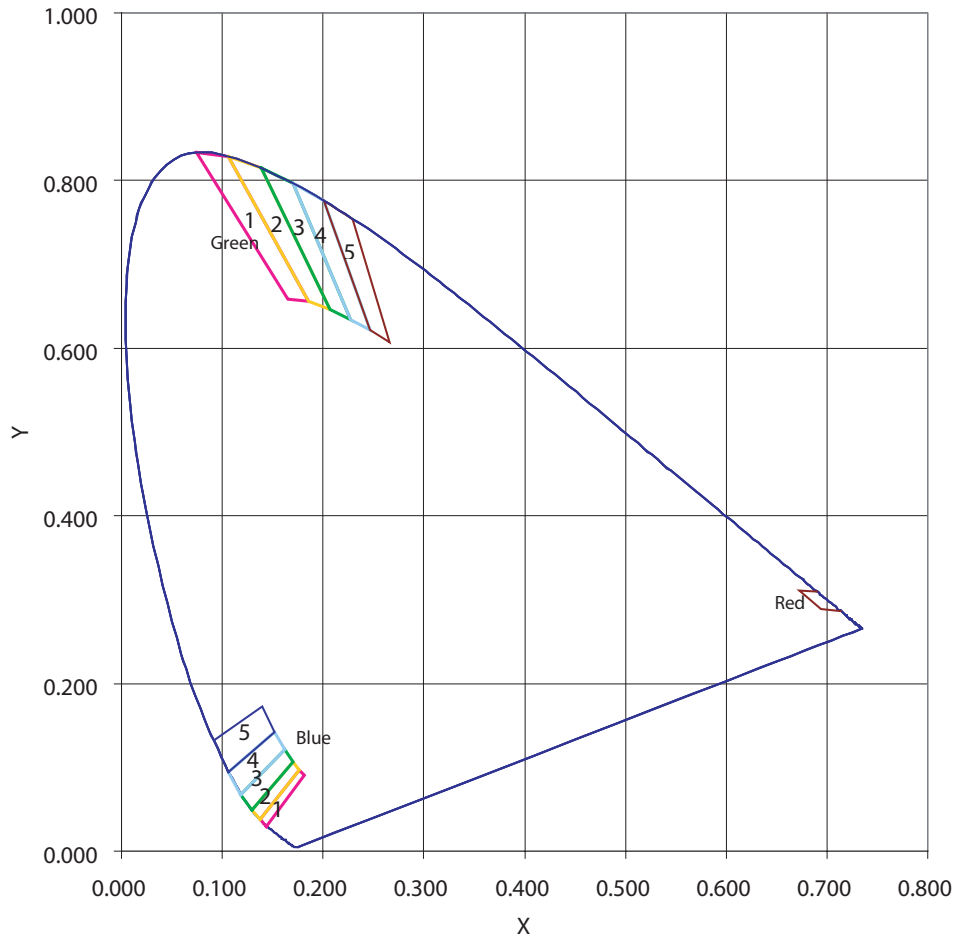

### Relative Light Output vs. Junction Temperature

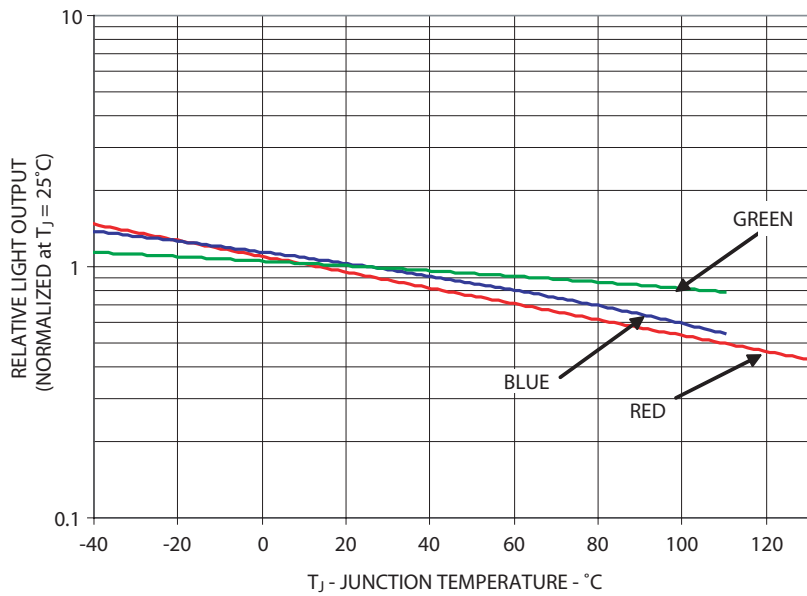



## Precautions:

### Lead Forming:

- The leads of an LED lamp may be preformed or cut to length prior to insertion and soldering on PC board.
- For better control, it is recommended to use proper tool to precisely form and cut the leads to applicable length rather than doing it manually.
- If manual lead cutting is necessary, cut the leads after the soldering process. The solder connection forms a mechanical ground which prevents mechanical stress due to lead cutting from traveling into LED package. This is highly recommended for hand solder operation, as the excess lead length also acts as small heat sink.

### Soldering and Handling:

- Care must be taken during PCB assembly and soldering process to prevent damage to the LED component.
- LED component may be effectively hand soldered to PCB. However, it is only recommended under unavoidable circumstances such as rework. The closest manual soldering distance of the soldering heat source (soldering iron's tip) to the body is 1.59mm. Soldering the LED using soldering iron tip closer than 1.59mm might damage the LED.

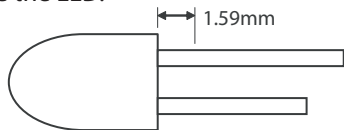

- ESD precaution must be properly applied on the soldering station and personnel to prevent ESD damage to the LED component that is ESD sensitive. Do refer to Avago application note AN 1142 for details. The soldering iron used should have grounded tip to ensure electrostatic charge is properly grounded.
- Recommended soldering condition:

	Wave Soldering [1, 2]	Manual Solder Dipping
Pre-heat temperature	105 °C Max.	-
Preheat time	60 sec Max	-
Peak temperature	250 °C Max.	260 °C Max.
Dwell time	3 sec Max.	5 sec Max

Note:

- 1) Above conditions refers to measurement with thermocouple mounted at the bottom of PCB.
  - 2) It is recommended to use only bottom preheaters in order to reduce thermal stress experienced by LED.
- Wave soldering parameters must be set and maintained according to the recommended temperature and dwell time. Customer is advised to perform daily check on the soldering profile to ensure that it is always conforming to recommended soldering conditions.

Note:

1. PCB with different size and design (component density) will have different heat mass (heat capacity). This might cause a change in temperature experienced by the board if same wave soldering setting is used. So, it is recommended to re-calibrate the soldering profile again before loading a new type of PCB.
2. Avago Technologies' high brightness LED are using high efficiency LED die with single wire bond as shown below. Customer is advised to take extra precaution during wave soldering to ensure that the maximum wave temperature does not exceed 250°C and the solder contact time does not exceeding 3sec. Over-stressing the LED during soldering process might cause premature failure to the LED due to delamination.

## Avago Technologies LED configuration

Note: Electrical connection between bottom surface of LED die and

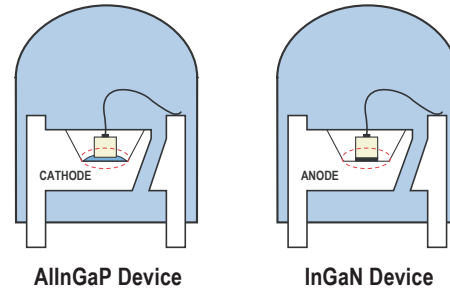

the lead frame is achieved through conductive paste.

- Any alignment fixture that is being applied during wave soldering should be loosely fitted and should not apply weight or force on LED. Non metal material is recommended as it will absorb less heat during wave soldering process.
- At elevated temperature, LED is more susceptible to mechanical stress. Therefore, PCB must allowed to cool down to room temperature prior to handling, which includes removal of alignment fixture or pallet.
- If PCB board contains both through hole (TH) LED and other surface mount components, it is recommended that surface mount components be soldered on the top side of the PCB. If surface mount need to be on the bottom side, these components should be soldered using reflow soldering prior to insertion the TH LED.
- Recommended PC board plated through holes (PTH) size for LED component leads.

LED component lead size	Diagonal	Plated through hole diameter
0.45 x 0.45 mm (0.018x 0.018 inch)	0.636 mm (0.025 inch)	0.98 to 1.08 mm (0.039 to 0.043 inch)
0.50 x 0.50 mm (0.020x 0.020 inch)	0.707 mm (0.028 inch)	1.05 to 1.15 mm (0.041 to 0.045 inch)

- Over-sizing the PTH can lead to twisted LED after clinching. On the other hand under sizing the PTH can cause difficulty inserting the TH LED.

Refer to application note AN5334 for more information about soldering and handling of high brightness TH LED lamps.

### Example of Wave Soldering Temperature Profile for TH LED

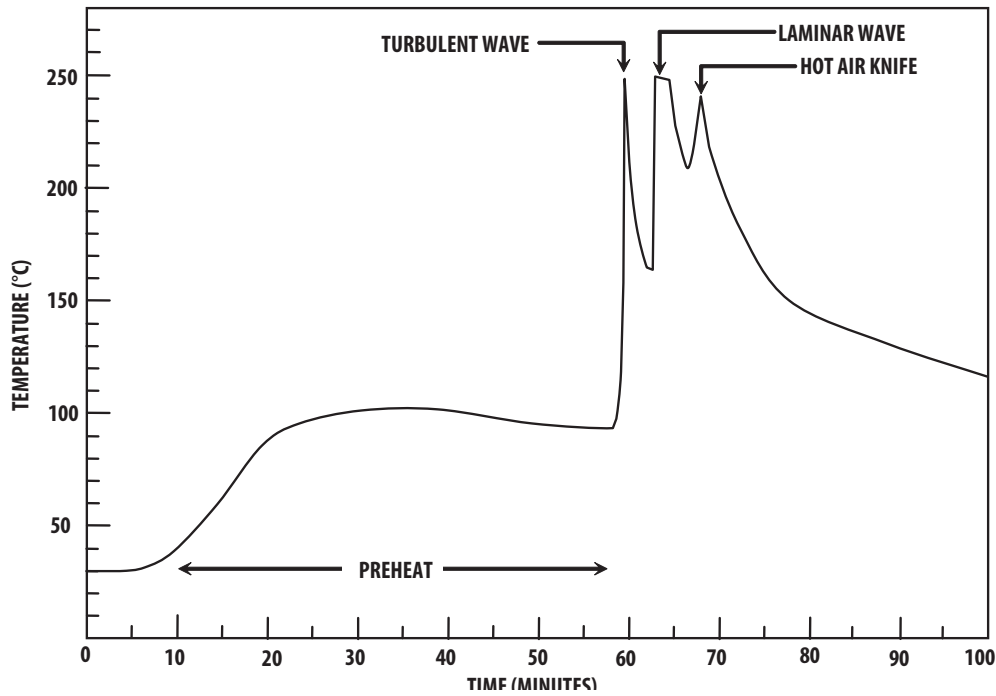

Recommended solder:  
 Sn63 (Leaded solder alloy)  
 SAC305 (Lead free solder alloy)

Flux: Rosin flux

Solder bath temperature:  
 245°C ± 5°C (maximum peak temperature = 250°C)

Dwell time: 1.5 sec - 3.0 sec  
 (maximum = 3sec)

Note: Allow for board to be sufficiently cooled to room temperature before exerting mechanical force.

### Ammo Packs Drawing

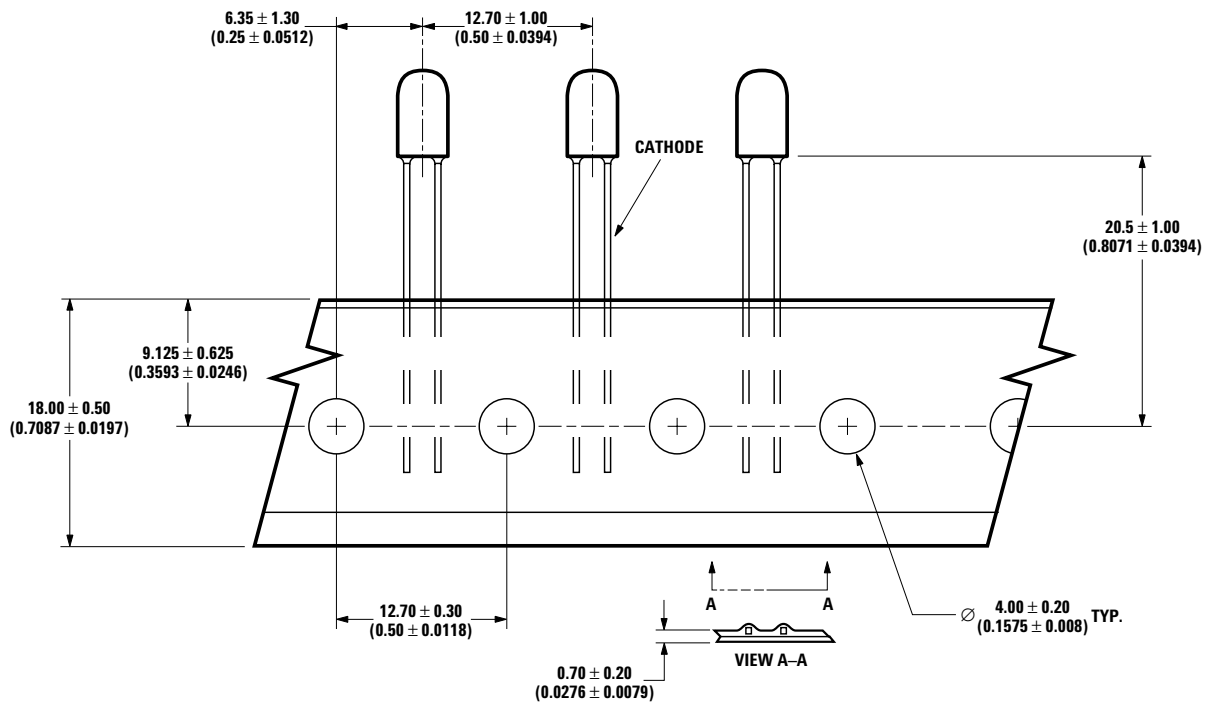

ALL DIMENSIONS IN MILLIMETERS (INCHES).

Note: The ammo-packs drawing is applicable for packaging option -DD & -ZZ and regardless of standoff or non-standoff.

## Packaging Box for Ammo Packs

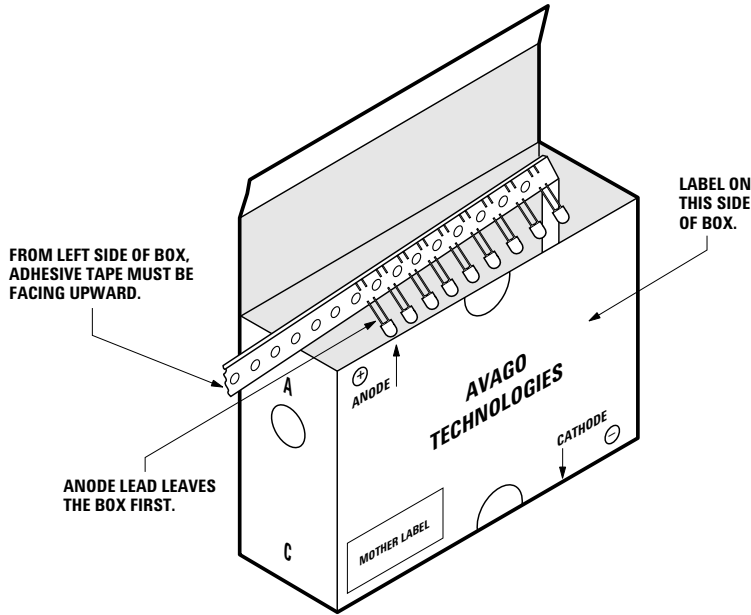

**Note:** For InGaN device, the ammo pack packaging box contains ESD logo.

## Packaging Label

(i) Avago Mother Label: (Available on packaging box of ammo pack and shipping box)

<p>(1P) Item: Part Number  </p>		<p><b>AVAGO</b>          TECHNOLOGIES          STANDARD LABEL LS0002          RoHS Compliant          e3 max temp 250C</p>
<p>(1T) Lot: Lot Number  </p>		
<p>LPN:  </p>		
<p>(9D)MFG Date: Manufacturing Date  </p>		
		<p>(Q) QTY: Quantity  </p>
		<p>CAT: Intensity Bin  </p>
		<p>BIN: Refer to below information</p>
<hr/>		
<p>(P) Customer Item:  </p>		
<p>(V) Vendor ID:  </p>	<p>(9D) Date Code: Date Code  </p>	
<p>DeptID:  </p>	<p>Made In: Country of Origin  </p>	

(ii) Avago Baby Label (Only available on bulk packaging)

 <b>Lamps Baby Label</b>		RoHS Compliant e3 max temp 250C
(1P) PART #: Part Number 		
(1T) LOT #: Lot Number 		
(9D)MFG DATE: Manufacturing Date 	QUANTITY: Packing Quantity 	
C/O: Country of Origin		
Customer P/N: 	CAT: Intensity Bin 	
Supplier Code: 	BIN: Refer to below information 	
	DATECODE: Date Code 	

**Acronyms and Definition:**

BIN:

- (i) Color bin only or VF bin only  
(Applicable for part number with color bins but without VF bin OR part number with VF bins and no color bin)  
OR
- (ii) Color bin incorporated with VF Bin  
(Applicable for part number that have both color bin and VF bin)

**Example:**

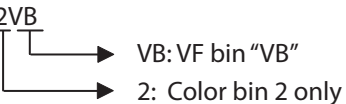
- (i) Color bin only or VF bin only  
BIN: 2 (represent color bin 2 only)  
BIN: VB (represent VF bin "VB" only)
- (ii) Color bin incorporate with VF Bin  
BIN: 2VB  

**DISCLAIMER:** AVAGO'S PRODUCTS AND SOFTWARE ARE NOT SPECIFICALLY DESIGNED, MANUFACTURED OR AUTHORIZED FOR SALE AS PARTS, COMPONENTS OR ASSEMBLIES FOR THE PLANNING, CONSTRUCTION, MAINTENANCE OR DIRECT OPERATION OF A NUCLEAR FACILITY OR FOR USE IN MEDICAL DEVICES OR APPLICATIONS. CUSTOMER IS SOLELY RESPONSIBLE, AND WAIVES ALL RIGHTS TO MAKE CLAIMS AGAINST AVAGO OR ITS SUPPLIERS, FOR ALL LOSS, DAMAGE, EXPENSE OR LIABILITY IN CONNECTION WITH SUCH USE.

For product information and a complete list of distributors, please go to our web site: [www.avagotech.com](http://www.avagotech.com)

Avago, Avago Technologies, and the A logo are trademarks of Avago Technologies in the United States and other countries. Data subject to change. Copyright © 2005-2008 Avago Technologies. All rights reserved. Obsoletes AV01-0418EN AV02-0339EN - September 2, 2008

