

# HLMP-FW00

## 5mm Flat Top InGaN White LED Lamp



### Data Sheet



Lead (Pb) Free  
RoHS 6 fully  
compliant



#### Description

This wide viewing angle white LED lamp is based on InGaN material technology. A blue LED die is coated by a phosphor to produce white. The typical resulting color is described by the coordinates  $x = 0.32$ ,  $y = 0.32$  using the 1931 CIE Chromaticity Diagram.

#### Benefit

- Reduced Power Consumption, Higher Reliability, and Increased Optical/Mechanical Design Flexibility Compared to Incandescent Bulbs and Other Alternative White Light Sources

#### Features

Wide viewing angle:  $90^\circ$

- Flat top
- High intensity InGaN technology

#### Applications

- Indoor Electronic Signs and Signals
- Small Area Illumination
- Legend Backlighting
- General Purpose Indicators

#### Package Dimensions

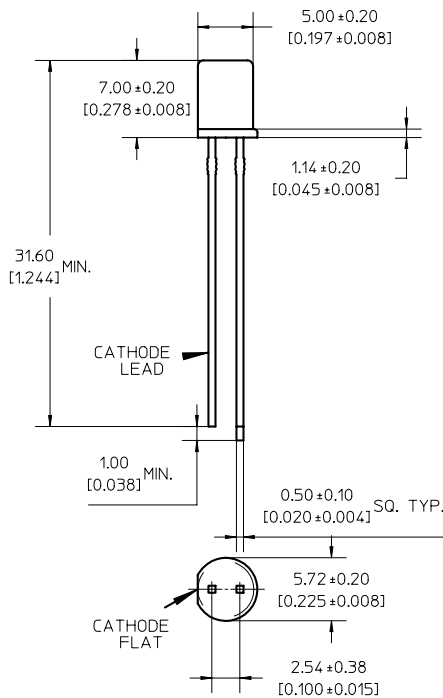

#### Notes :

1. All dimensions are in millimetres /inches.
2. Epoxy meniscus may extend about 1mm (0.040") down the leads.

**CAUTION :** These devices are Class 1C ESD sensitive. Please observe appropriate precautions during handling and processing. Refer to Avago Technologies Application Note AN-1142 for additional details.

## Device Selection Guide

Part Number	Min Luminous Intensity I <sub>v</sub> (mcd) @ 20mA	Max Luminous Intensity I <sub>v</sub> (mcd) @ 20mA
HLMP-FW00-JM0xx	240	680

Tolerance for intensity bin limit is +/-15%

### Absolute Maximum Ratings (T<sub>A</sub> = 25°C)

Parameter	Value	Units
DC Forward Current <sup>[1]</sup>	30	mA
Peak Forward Current <sup>[2]</sup>	100	mA
Power Dissipation	111	mW
Reverse Voltage (I <sub>R</sub> = 10μA)	5	V
LED Junction Temperature	110	°C
Operating Temperature Range	-40 to +85	°C
Storage Temperature Range	-40 to +100	°C

Notes:

1. Derate linearly as shown in Figure 5.
2. Duty factor 10%, 1 KHz.

### Electrical Characteristics (T<sub>A</sub> = 25°C)

Forward Voltage V <sub>F</sub> (V) @ I <sub>F</sub> = 20 mA		Reverse Breakdown V <sub>R</sub> (V) @ I <sub>R</sub> = 10μA	Capacitance C (pF), V <sub>F</sub> = 0, f = 1 MHz	Thermal Resistance R <sub>θJ-PIN</sub> (°C/W)
Typ.	Max.	Min.	Typ.	Typ.
3.2	3.7	5	70	240

### Optical Characteristics (T<sub>A</sub> = 25°C)

Typical Chromaticity Coordinates <sup>[1]</sup>		Viewing Angle 2θ <sub>1/2</sub> Degrees <sup>[2]</sup>
x	y	Typ.
0.32	0.32	90°

Notes:

1. The chromaticity coordinates are derived from the CIE 1931 Chromaticity Diagram and represent the perceived color of the device.
2. θ<sub>1/2</sub> is the off-axis angle where the luminous intensity is ½ the peak intensity.

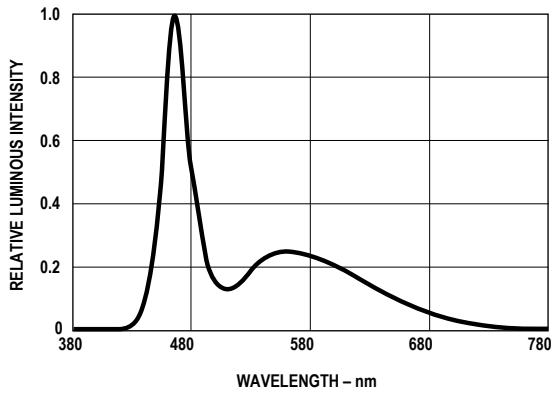

Figure 1. Relative Intensity vs Wavelength

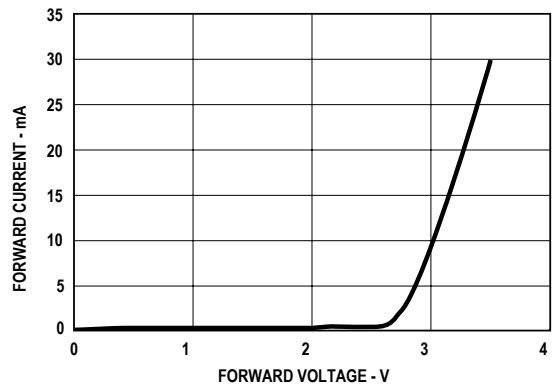

Figure 2. Forward Current vs Forward Voltage

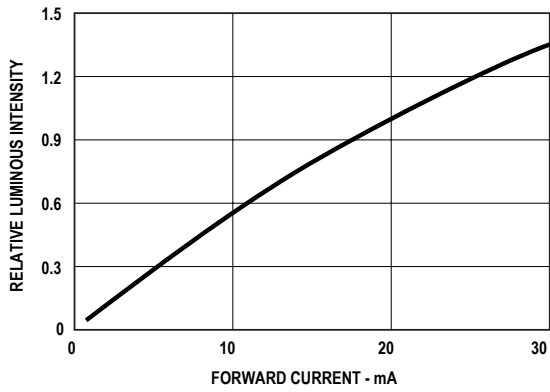

Figure 3. Relative Iv vs. Forward Current

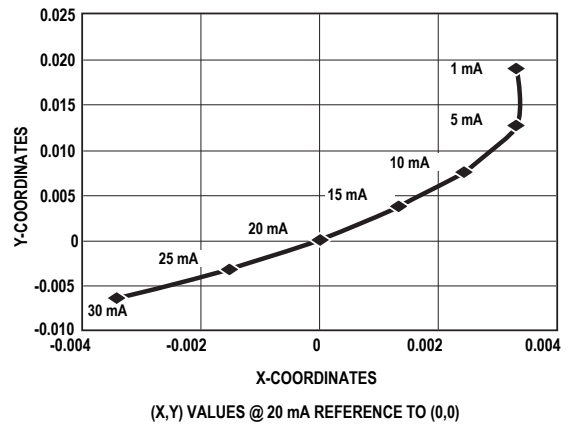

Figure 4. Chromaticity shift vs. current

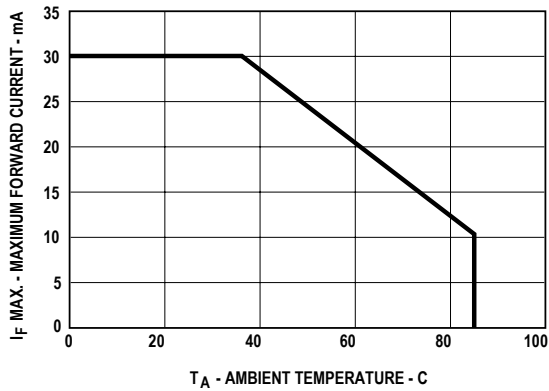

Figure 5. Maximum Fwd. Current vs Temperature

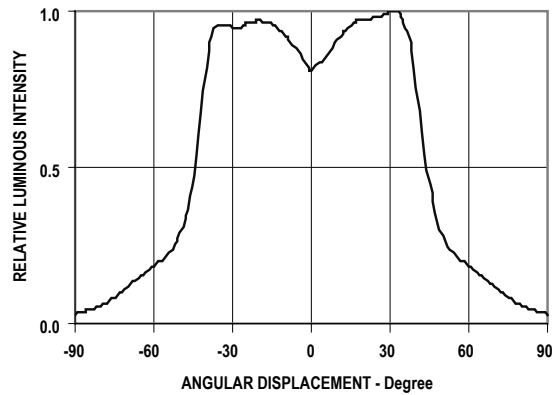

Figure 6. Spatial Radiation Pattern

### Intensity Bin Limits (mcd at 20 mA)

Bin	Min.	Max.
J	240	310
K	310	400
L	400	520
M	520	680

Tolerance for each bin limit is  $\pm 15\%$

### Color Bin Limit Tables

Rank	Limits (Chromaticity Coordinates)				
1	x	0.330	0.330	0.356	0.361
	y	0.360	0.318	0.351	0.385
2	x	0.287	0.296	0.330	0.330
	y	0.295	0.276	0.318	0.339
3	x	0.264	0.280	0.296	0.283
	y	0.267	0.248	0.276	0.305
4	x	0.283	0.287	0.330	0.330
	y	0.305	0.295	0.339	0.360

Tolerance for each bin limit is  $\pm 0.01$

### Relative Light Output vs. Junction Temperature

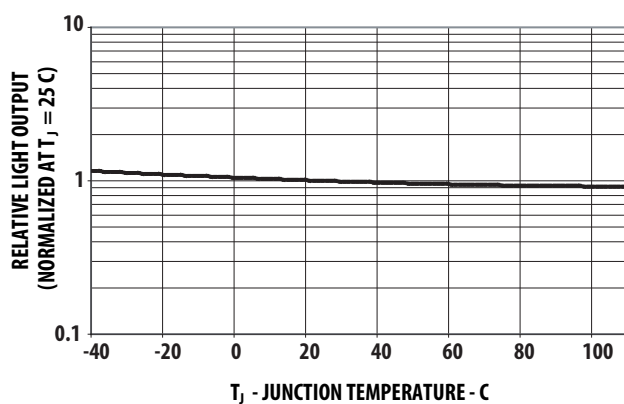

### Color Bin Limits with Respect to CIE 1931 Chromaticity Diagram

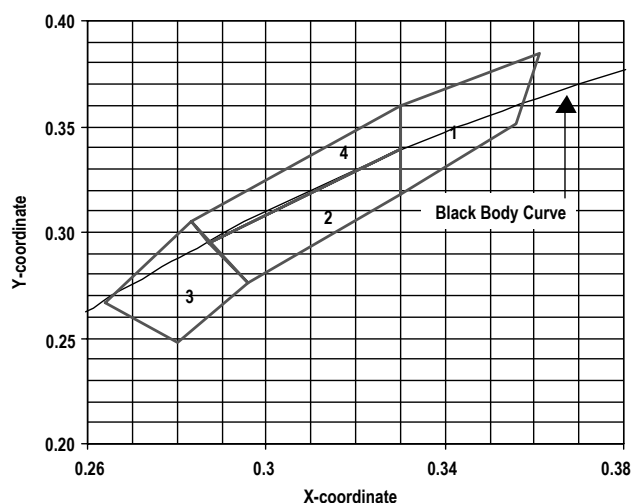

Note:

1. Bin categories are established for classification of products. Products may not be available in all bin categories. Please contact your Avago representative for information on currently available

**Precautions:**

**Lead Forming:**

- The leads of an LED lamp may be preformed or cut to length prior to insertion and soldering on PC board.
- For better control, it is recommended to use proper tool to precisely form and cut the leads to applicable length rather than doing it manually.
- If manual lead cutting is necessary, cut the leads after the soldering process. The solder connection forms a mechanical ground which prevents mechanical stress due to lead cutting from traveling into LED package. This is highly recommended for hand solder operation, as the excess lead length also acts as small heat sink.

**Soldering and Handling:**

- Care must be taken during PCB assembly and soldering process to prevent damage to the LED component.
- LED component may be effectively hand soldered to PCB. However, it is only recommended under unavoidable circumstances such as rework. The closest manual soldering distance of the soldering heat source (soldering iron's tip) to the body is 1.59mm. Soldering the LED using soldering iron tip closer than 1.59mm might damage the LED.

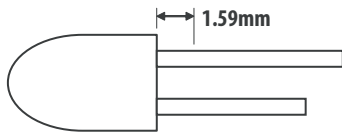

- ESD precaution must be properly applied on the soldering station and personnel to prevent ESD damage to the LED component that is ESD sensitive. Do refer to Avago application note AN 1142 for details. The soldering iron used should have grounded tip to ensure electrostatic charge is properly grounded.
- Recommended soldering condition:

	<b>Wave Soldering</b> [1,2]	<b>Manual Solder Dipping</b>
Pre-heat temperature	105 °C Max.	-
Preheat time	60 sec Max	-
Peak temperature	250 °C Max.	260 °C Max.
Dwell time	3 sec Max.	5 sec Max

Note:

- 1) Above conditions refers to measurement with thermocouple mounted at the bottom of PCB.
  - 2) It is recommended to use only bottom preheaters in order to reduce thermal stress experienced by LED.
- Wave soldering parameters must be set and maintained according to the recommended temperature and dwell time. Customer is advised to perform daily check on the soldering profile to ensure that it is always conforming to recommended soldering conditions.

Note:

1. PCB with different size and design (component density) will have different heat mass (heat capacity). This might cause a change in temperature experienced by the board if same wave soldering setting is used. So, it is recommended to re-calibrate the soldering profile again before loading a new type of PCB.
2. Avago Technologies' high brightness LED are using high efficiency LED die with single wire bond as shown below. Customer is advised to take extra precaution during wave soldering to ensure that the maximum wave temperature does not exceed 250°C and the solder contact time does not exceeding 3sec. Over-stressing the LED during soldering process might cause premature failure to the LED due to delamination.

**Avago Technologies LED configuration**

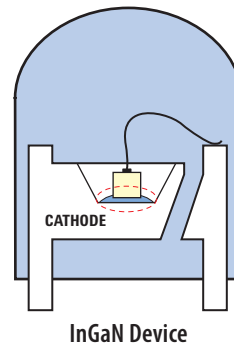

Note: Electrical connection between bottom surface of LED die and the lead frame is achieved through conductive paste.

- Any alignment fixture that is being applied during wave soldering should be loosely fitted and should not apply weight or force on LED. Non metal material is recommended as it will absorb less heat during wave soldering process.
- At elevated temperature, LED is more susceptible to mechanical stress. Therefore, PCB must allowed to cool down to room temperature prior to handling, which includes removal of alignment fixture or pallet.
- If PCB board contains both through hole (TH) LED and other surface mount components, it is recommended that surface mount components be soldered on the top side of the PCB. If surface mount need to be on the bottom side, these components should be soldered using reflow soldering prior to insertion the TH LED.
- Recommended PC board plated through holes (PTH) size for LED component leads.

<b>LED component lead size</b>	<b>Diagonal</b>	<b>Plated through hole diameter</b>
0.45 x 0.45 mm (0.018x 0.018 inch)	0.636 mm (0.025 inch)	0.98 to 1.08 mm (0.039 to 0.043 inch)
0.50 x 0.50 mm (0.020x 0.020 inch)	0.707 mm (0.028 inch)	1.05 to 1.15 mm (0.041 to 0.045 inch)

- Over-sizing the PTH can lead to twisted LED after clinching. On the other hand under sizing the PTH can cause difficulty inserting the TH LED.

Refer to application note AN5334 for more information about soldering and handling of high brightness TH LED lamps.

### Example of Wave Soldering Temperature Profile for TH LED

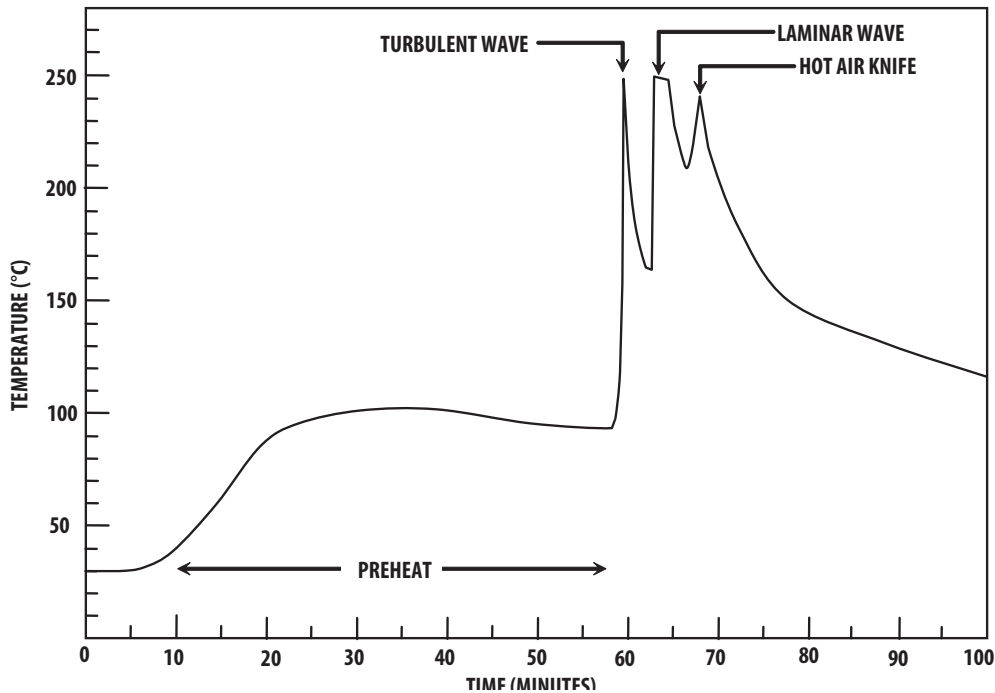

Recommended solder:  
Sn63 (Leaded solder alloy)  
SAC305 (Lead free solder alloy)

Flux: Rosin flux

Solder bath temperature:  
245°C ± 5°C (maximum peak  
temperature = 250°C)

Dwell time: 1.5 sec - 3.0 sec  
(maximum = 3sec)











Note: Allow for board to be  
sufficiently cooled to room  
temperature before exerting  
mechanical force.

### Packaging Label

(i) Avago Mother Label: (Available on packaging box of ammo pack and shipping box)

<b>AVAGO</b> TECHNOLOGIES	
(1P) Item: <b>Part Number</b>	STANDARD LABEL LS0002
	RoHS Compliant
(1T) Lot: <b>Lot Number</b>	e1 max temp 250C
	(Q) QTY: <b>Quantity</b>
LPN	
	CAT: <b>Intensity Bin</b>
(9D) MFG Date: <b>Manufacturing Date</b>	
	BIN: <b>Refer to below information</b>
(P) Customer Item:	REV:
(V) Vendor ID	DeptID:
Made In: <b>Country of Origin</b>	

(ii) Avago Baby Label (Only available on bulk packaging)

		RoHS Compliant e1 max temp 250C
PART #: Part Number		
LOT#: Lot Number		
MFG DATE: Manufacturing Date		QUANTITY: Packing Quantity
C/O: Country of Origin		
Customer P/N:		CAT: Intensity Bin
Supplier Code:		
		BIN: Refer to below information
		
		DATECODE: Date Code
		

**Acronyms and Definition:**

BIN:

(i) Color bin only or VF bin only

(Applicable for part number with color bins but without VF bin OR part number with VF bins and no color bin)

OR

(ii) Color bin incorporated with VF Bin

(Applicable for part number that have both color bin and VF bin)

**Example:**

(i) Color bin only or VF bin only

BIN: 2 (represent color bin 2 only)

BIN: VB (represent VF bin "VB" only)

(ii) Color bin incorporate with VF Bin

BIN: 2VB

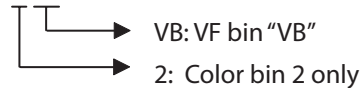

**DISCLAIMER:** AVAGO'S PRODUCTS AND SOFTWARE ARE NOT SPECIFICALLY DESIGNED, MANUFACTURED OR AUTHORIZED FOR SALE AS PARTS, COMPONENTS OR ASSEMBLIES FOR THE PLANNING, CONSTRUCTION, MAINTENANCE OR DIRECT OPERATION OF A NUCLEAR FACILITY OR FOR USE IN MEDICAL DEVICES OR APPLICATIONS. CUSTOMER IS SOLELY RESPONSIBLE, AND WAIVES ALL RIGHTS TO MAKE CLAIMS AGAINST AVAGO OR ITS SUPPLIERS, FOR ALL LOSS, DAMAGE, EXPENSE OR LIABILITY IN CONNECTION WITH SUCH USE.

For product information and a complete list of distributors, please go to our web site: [www.avagotech.com](http://www.avagotech.com)