

20 mm (0.8 inch) Seven Segment Displays

Technical Data

HDSP-390X Series
HDSP-420X Series
HDSP-860X Series
HDSP-N15X Series

Features

- **Industry Standard Size**
- **Industry Standard Pinout**
15.24 mm (0.6 in.) DIP Leads
on 2.54 mm (0.1 in.) Centers
- **Choice of Colors**
AlGaAs Red, High Efficiency
Red, Yellow, Green
- **Excellent Appearance**
Evenly Lighted Segments
Mitered Corners on Segments
Gray Package Gives Optimum
Contrast
± 50° Viewing Angle
- **Design Flexibility**
Common Anode or Common
Cathode
Left and Right Hand Decimal
Points
± 1. Overflow Character
- **Categorized for Luminous
Intensity**
Yellow and Green Categorized

for Color

Use of Like Categories Yields a
Uniform Display

- **High Light Output**
- **High Peak Current**
- **Excellent for Long Digit
String Multiplexing
Intensity and Color
Selection Option**
See Intensity and Color
Selected Displays Data Sheet
- **Sunlight Viewable AlGaAs**

Description

The 20 mm (0.8 inch) LED seven segment displays are designed for viewing distances up to 10 metres (33 feet). These devices use an industry standard size package and pinout. All devices are available as either common anode or common cathode.

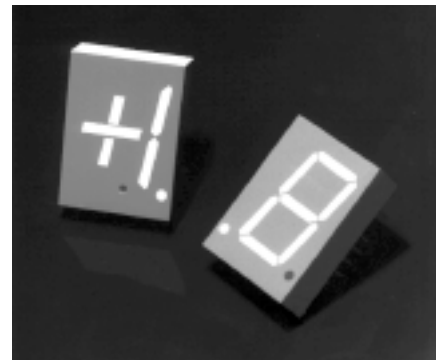

These displays are ideal for most applications. Pin for pin equivalent displays are also available in a low current design. The low current displays are ideal for portable applications. For additional information see the Low Current Seven Segment Displays data sheet.

Devices

AlGaAs ^[1] HDSP-	HER HDSP-	Yellow HDSP-	Green HDSP-	Description	Package Drawing
N150	3900	4200	8600	Common Anode Left Hand Decimal	A
N151	3901	4201	8601	Common Anode Right Hand Decimal	B
N153	3903	4203	8603	Common Cathode Right Hand Decimal	C
N155	3905	4205	8605	Common Cathode Left Hand Decimal	D
N156	3906	4206	8606	Universal ± 1. Overflow ^[2]	E

Notes:

1. These displays are recommended for high ambient light operation. Please refer to the HDSP-N10X AlGaAs data sheet for low current operation.
2. Universal pinout brings the anode and cathode of each segment's LED out to separate pins. See internal diagram E.

Part Numbering System

5082 -X X X X-X X X X X

HDSP-X X X X-X X X X X

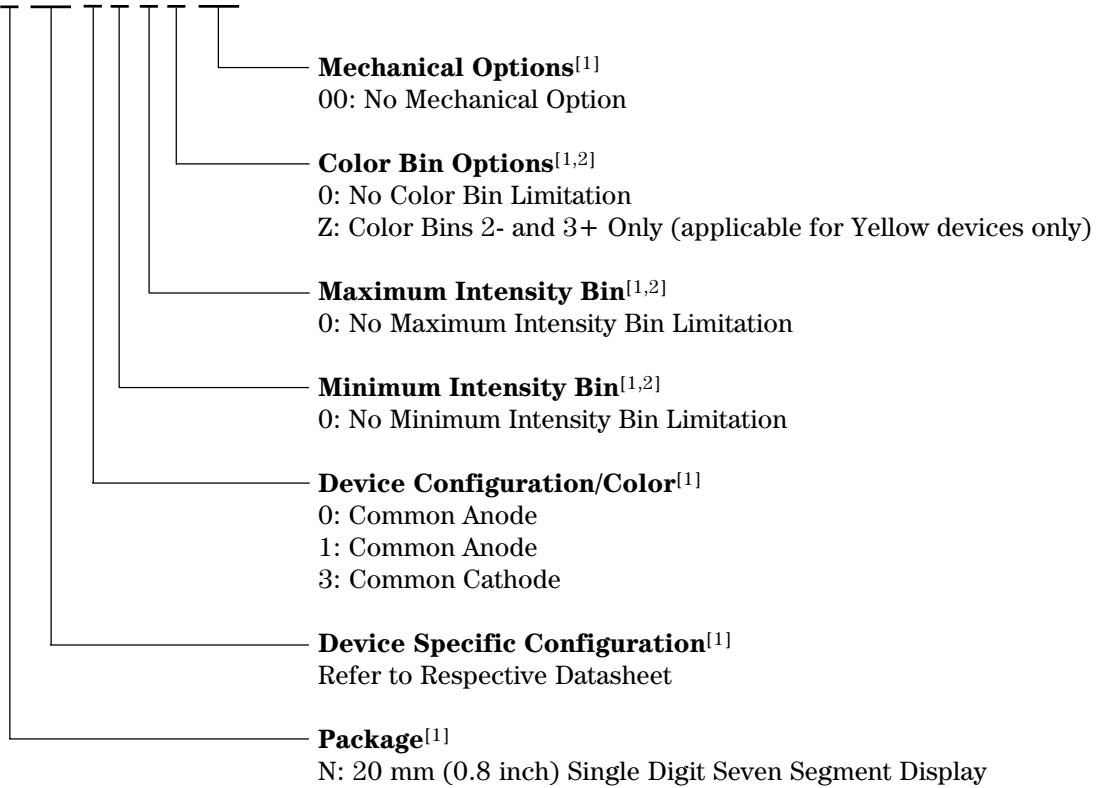

Notes:

- For codes not listed in the figure above, please refer to the respective datasheet or contact your nearest Agilent representative for details.
- Bin options refer to shippable bins for a part number. Color and Intensity Bins are typically restricted to 1 bin per tube (exceptions may apply). Please refer to respective datasheet for specific bin limit information.

Package Dimensions

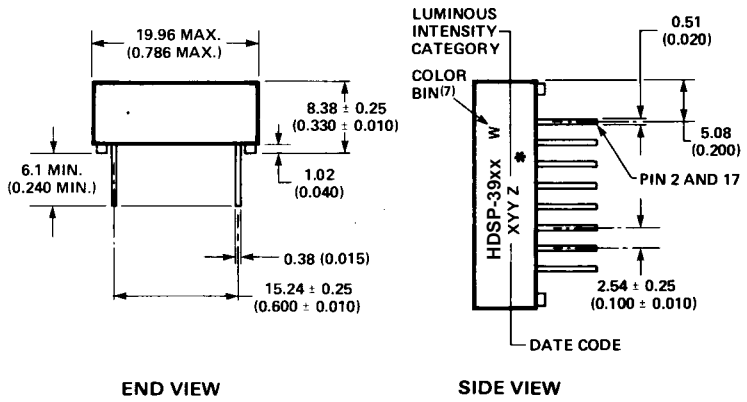
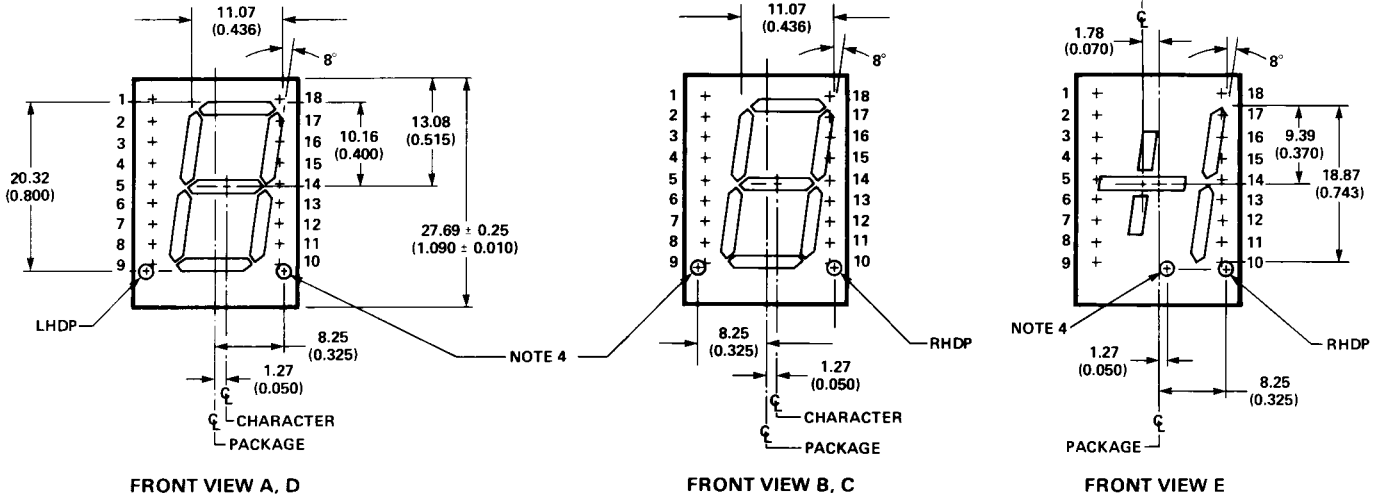

Pin	Function				
	A	B	C	D	E
1	NO PIN	NO PIN	NO PIN	NO PIN	NO PIN
2	CATHODE a	CATHODE a	ANODE a	ANODE a	CATHODE a
3	CATHODE f	CATHODE f	ANODE f	ANODE f	ANODE d
4	ANODE ^[3]	ANODE ^[3]	CATHODE ^[6]	CATHODE ^[6]	CATHODE d
5	CATHODE e	CATHODE e	ANODE e	ANODE e	CATHODE c
6	ANODE ^[3]	ANODE ^[3]	CATHODE ^[6]	CATHODE ^[6]	CATHODE e
7	CATHODE dp	NO. CONNec.	NO. CONNec.	ANODE dp	ANODE e
8	NO PIN	NO PIN	NO PIN	NO PIN	CATHODE dp
9	NO PIN	NO PIN	NO PIN	NO PIN	NO PIN
10	NO PIN	CATHODE dp	ANODE dp	NO PIN	ANODE dp
11	CATHODE d	CATHODE d	ANODE d	ANODE d	CATHODE dp
12	ANODE ^[3]	ANODE ^[3]	CATHODE ^[6]	CATHODE ^[6]	CATHODE b
13	CATHODE c	CATHODE c	ANODE c	ANODE c	ANODE b
14	CATHODE g	CATHODE g	ANODE g	ANODE g	ANODE c
15	CATHODE b	CATHODE b	ANODE b	ANODE b	ANODE a
16	NO PIN	NO PIN	NO PIN	NO PIN	NO PIN
17	ANODE ^[3]	ANODE ^[3]	CATHODE ^[6]	CATHODE ^[6]	CATHODE a
18	NO PIN	NO PIN	NO PIN	NO PIN	NO PIN

- NOTES:
1. DIMENSIONS IN MILLIMETERS AND (INCHES).
 2. ALL UNTOLERANCED DIMENSIONS ARE FOR REFERENCE ONLY.
 3. REDUNDANT ANODES.
 4. UNUSED dp POSITION.
 5. SEE INTERNAL CIRCUIT DIAGRAM.
 6. REDUNDANT CATHODES.
 7. FOR HDSP-4200/-8600 SERIES PRODUCT ONLY.

Internal Circuit Diagram

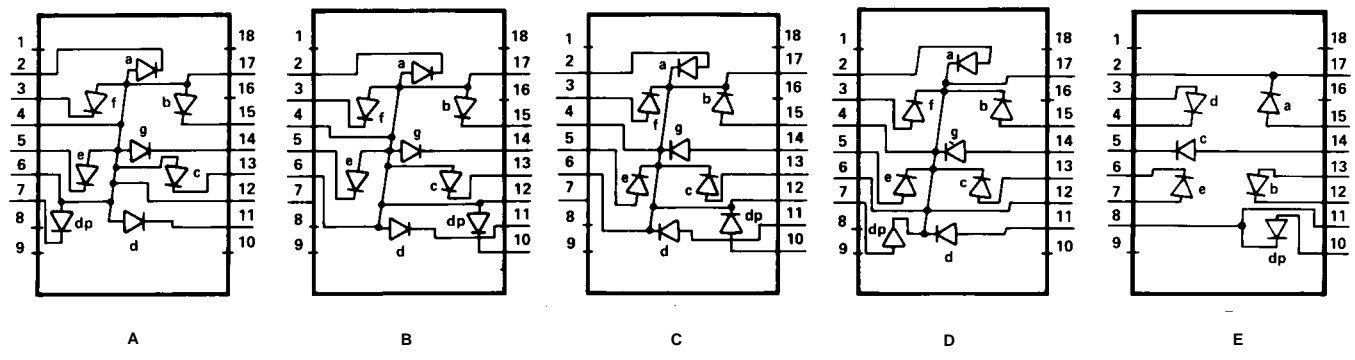

Absolute Maximum Ratings

Description	AlGaAs Red HDSP-N150 Series	HER HDSP-3900 Series	Yellow HDSP-4200 Series	Green HDSP-8600 Series	Units
Average Power per Segment or DP	96	105	105	105	mW
Peak Forward Current per Segment or DP	160 ^[1]	135 ^[3]	135 ^[3]	90 ^[5]	mA
DC Forward Current per Segment or DP	40 ^[2]	40 ^[4]	40 ^[4]	30 ^[6]	mA
Operating Temperature Range	-20 to +100 ^[7]	-40 to +100		-40 to +100	°C
Storage Temperature Range	-55 to +100				°C
Reverse Voltage per Segment or DP	3.0				V
Wave Soldering Temperature for 3 Seconds (1.60 mm [0.063 in.] below body)	250				°C

Notes:

1. See Figure 2 to establish pulsed conditions.
2. Derate above 55°C at 0.8 mA/°C.
3. See Figure 7 to establish pulsed conditions.
4. Derate above 50°C at 0.73 mA/°C.
5. See Figure 8 to establish pulsed conditions.
6. Derate above 50°C at 0.54 mA/°C.
7. For operation below -20°C, contact your local Agilent components sales office or an authorized distributor.

Electrical/Optical Characteristics at $T_A = 25^\circ\text{C}$

AlGaAs Red

Device Series	Parameter	Symbol	Min.	Typ.	Max.	Units	Test Conditions
HDSP-N15X	Luminous Intensity/Segment ^[1,2,5] (Digit Average)	I_V	6.0	14.0		mcad	$I_F = 20\text{ mA}$
	Forward Voltage/Segment or DP	V_F		1.8		V	$I_F = 20\text{ mA}$
				2.0	3.0	V	$I_F = 100\text{ mA}$
	Peak Wavelength	λ_{PEAK}		645		nm	
	Dominant Wavelength ^[3]	λ_d		637		nm	
	Reverse Voltage/Segment or DP ^[4]	V_R	3.0	15		V	$I_R = 100\text{ }\mu\text{A}$
	Temperature Coefficient of V_F /Segment or DP	$\Delta V_F/^\circ\text{C}$		-2		mV/°C	
Thermal Resistance LED Junction-to-Pin	$R\theta_{\text{J-PIN}}$		430		°C/W/Seg		

High Efficiency Red

Device Series	Parameter	Symbol	Min.	Typ.	Max.	Units	Test Conditions
HDSP-390X	Luminous Intensity/Segment ^[1,2] (Digit Average)	I_V	3350	7000		μcd	$I_F = 100\text{ mA Peak: 1 of 5 df}$
				4800		μcd	$I_F = 20\text{ mA}$
	Forward Voltage/Segment or DP	V_F		2.6	3.5	V	$I_F = 100\text{ mA}$
	Peak Wavelength	λ_{PEAK}		635		nm	
	Dominant Wavelength ^[3]	λ_d		626		nm	
	Reverse Voltage/Segment or DP ^[4]	V_R	3.0	25		V	$I_R = 100\text{ }\mu\text{A}$
	Temperature Coefficient of V_F /Segment or DP	$\Delta V_F/^\circ\text{C}$		-2		mV/°C	
Thermal Resistance LED Junction-to-Pin	$R\theta_{\text{J-PIN}}$		375		°C/W/Seg		

Yellow

Device Series	Parameter	Symbol	Min.	Typ.	Max.	Units	Test Conditions
HDSP-420X	Luminous Intensity/Segment ^[1,2] (Digit Average)	I _V	2200	7000		μcd	I _F = 100 mA Peak: 1 of 5 df
				3400		μcd	I _F = 20 mA
	Forward Voltage/Segment or DP	V _F		2.6	3.5	V	I _F = 100 mA
	Peak Wavelength	λ _{PEAK}		583		nm	
	Dominant Wavelength ^[3,6]	λ _d	581.5	586	592.5	nm	
	Reverse Voltage/Segment or DP ^[4]	V _R	3.0	25.0		V	I _R = 100 μA
	Temperature Coefficient of V _F /Segment or DP	ΔV _F /°C		-2		mV/°C	
Thermal Resistance LED Junction-to-Pin	Rθ _{J-PIN}		375		°C/W/ Seg		

Green

Device Series	Parameter	Symbol	Min.	Typ.	Max.	Units	Test Conditions
HDSP-860X	Luminous Intensity/Segment ^[1,2] (Digit Average)	I _V	680	1500		μcd	I _F = 10 mA
				1960		μcd	I _F = 50 mA Peak: 1 of 5 df
	Forward Voltage/Segment or DP	V _F		2.1	2.5	V	I _F = 10 mA
	Peak Wavelength	λ _{PEAK}		566		nm	
	Dominant Wavelength ^[3,6]	λ _d		571	577	nm	
	Reverse Voltage/Segment or DP ^[4]	V _R	3.0	50.0		V	I _R = 100 μA
	Temperature Coefficient of V _F /Segment or DP	ΔV _F /°C		-2		mV/°C	
Thermal Resistance LED Junction-to-Pin	Rθ _{J-PIN}		375		°C/W/ Seg		

Notes:

- Case temperature of the device immediately prior to the intensity measurement is 25°C.
- The digits are categorized for luminous intensity. The intensity category is designated by a letter on the side of the package.
- The dominant wavelength, λ_d, is derived from the CIE chromaticity diagram and is that single wavelength which defines the color of the device.
- Typical specification for reference only. Do not exceed absolute maximum ratings.
- For low current operation, the AlGaAs Red HDSP-N100 series displays are recommended. They are tested at 1 mA dc/segment and are pin for pin compatible with the HDSP-N150 series.
- The Yellow (HDSP-4200) and Green (HDSP-8600) displays are categorized for dominant wavelength. The category is designated by a number adjacent to the luminous intensity category letter.

AlGaAs Red

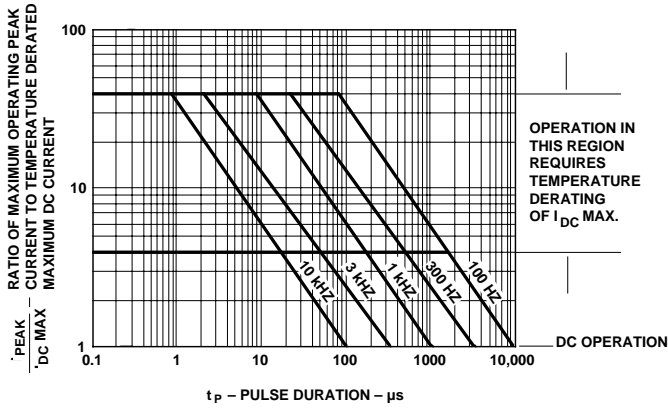

Figure 1. Maximum Allowed Peak Current vs. Pulse Duration – AlGaAs Red.

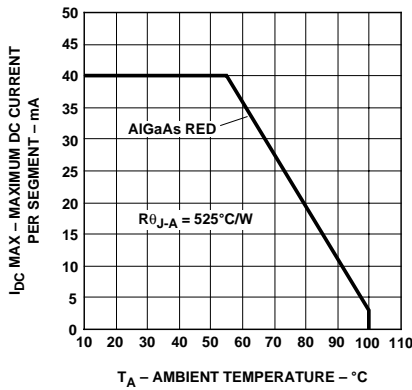

Figure 2. Maximum Allowable DC Current vs. Ambient Temperature.

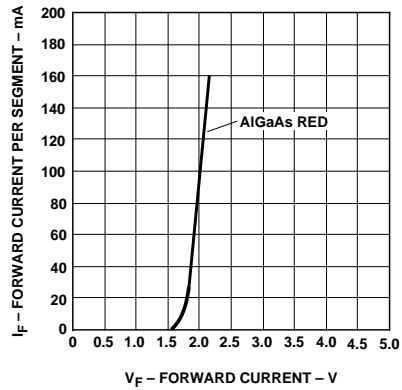

Figure 3. Forward Current vs. Forward Voltage.

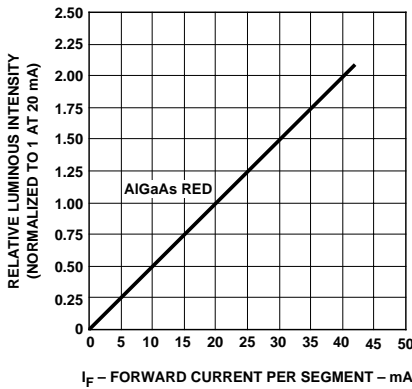

Figure 4. Relative Luminous Intensity vs. DC Forward Current.

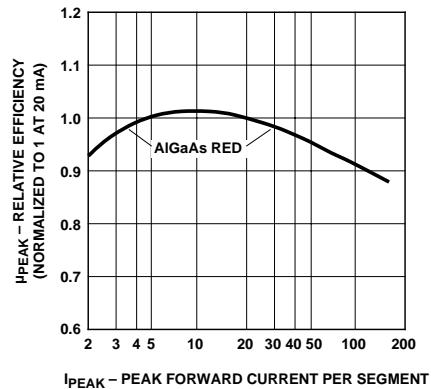

Figure 5. Relative Efficiency (Luminous Intensity per Unit Current) vs. Peak Current.

HER, Yellow, Green

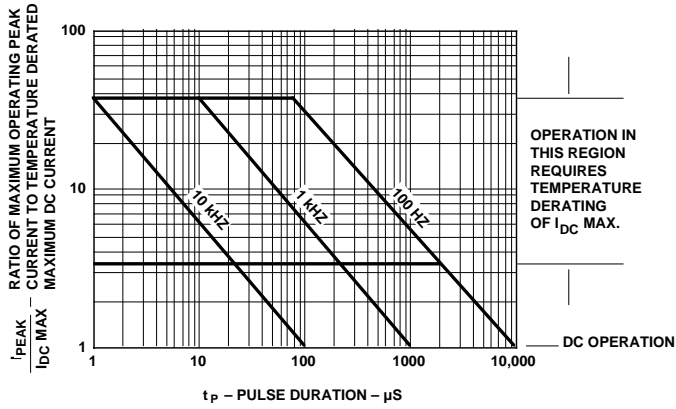

Figure 6. Maximum Allowed Peak Current vs. Pulse Duration - HER, Yellow.

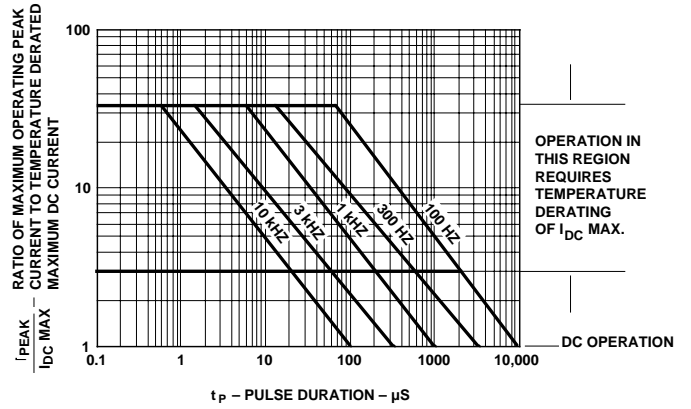

Figure 7. Maximum Allowed Peak Current vs. Pulse Duration - Green.

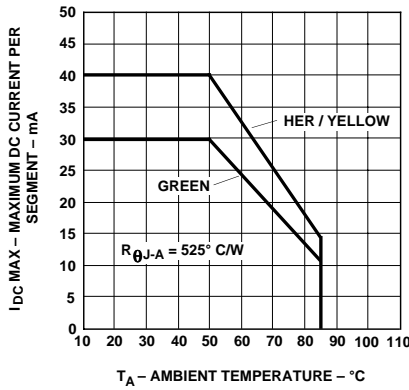

Figure 8. Maximum Allowable DC Current vs. Ambient Temperature.

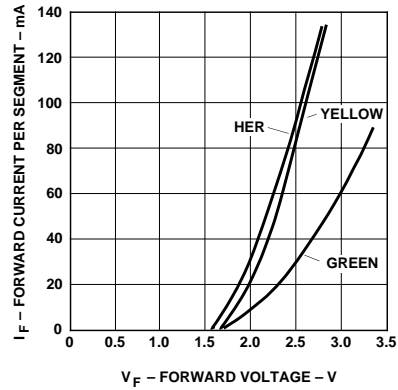

Figure 9. Forward Current vs. Forward Voltage.

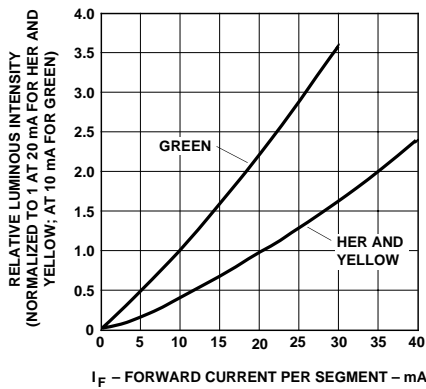

Figure 10. Relative Luminous Intensity vs. DC Forward Current.

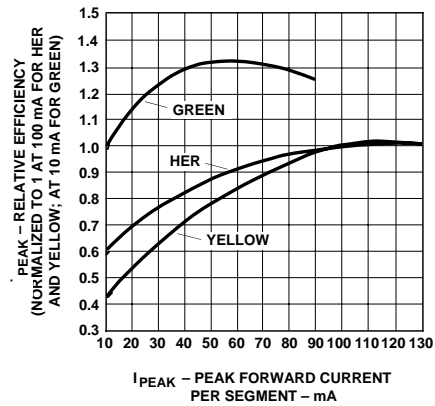

Figure 11. Relative Efficiency (Luminous Intensity per Unit Current) vs. Peak Current.

Intensity Bin Limits (mcd)

AlGaAs Red

HDSP-N15x		
IV Bin Category	Min.	Max.
J	6.14	11.20
K	9.20	16.90
L	13.80	25.30
M	20.70	38.00
N	31.10	56.90
O	46.60	85.40

Yellow

HDSP-420x		
IV Bin Category	Min.	Max.
C	2.23	4.09
D	3.35	6.14
E	5.02	9.21
F	7.53	13.82
G	11.30	20.72
H	16.95	31.08
I	25.43	46.62

Green

HDSP-860x		
IV Bin Category	Min.	Max.
D	1.03	1.88
E	1.54	2.82
F	2.31	4.25
G	3.47	6.37
H	5.21	9.55

HER

HDSP-390x		
IV Bin Category	Min.	Max.
D	3.35	6.14
E	5.02	9.21
F	7.53	13.82
G	11.30	20.72
H	16.95	31.08
I	25.43	46.62

Color Categories

Color	Bin	Dominant Wavelength (nm)	
		Min.	Max.
Yellow	1	581.50	585.00
	3	584.00	587.50
	2	586.50	590.00
	4	589.00	592.50
Green	2	573.00	577.00
	3	570.00	574.00
	4	567.00	571.00
	5	564.00	568.00

Note:

All categories are established for classification of products. Products may not be available in all categories. Please contact your Agilent representatives for further clarification/information.

Contrast Enhancement

For information on contrast enhancement, please see Application Note 1015.

Soldering/Cleaning

Cleaning agents from the ketone family (acetone, methyl ethyl ketone, etc.) and from the chlorinated hydrocarbon family (methylene chloride, trichloroethylene, carbon tetrachloride, etc.) are not recommended for cleaning LED parts. All of these various solvents attack or dissolve the encapsulating epoxies used to form the package of plastic LED parts.

For information on soldering LEDs, please refer to Application Note 1027.

www.agilent.com/semiconductors

For product information and a complete list of distributors, please go to our web site.

For technical assistance call:

Americas/Canada: +1 (800) 235-0312 or
(916) 788-6763

Europe: +49 (0) 6441 92460

China: 10800 650 0017

Hong Kong: (+65) 6756 2394

India, Australia, New Zealand: (+65) 6755 1939

Japan: (+81 3) 3335-8152(Domestic/
International), or 0120-61-1280(Domestic Only)

Korea: (+65) 6755 1989

Singapore, Malaysia, Vietnam, Thailand,
Philippines, Indonesia: (+65) 6755 2044

Taiwan: (+65) 6755 1843

Data subject to change.

Obsoletes 5964-6426EN

July 11, 2004

5988-1737EN