

HDJD-JD05

Development Kit

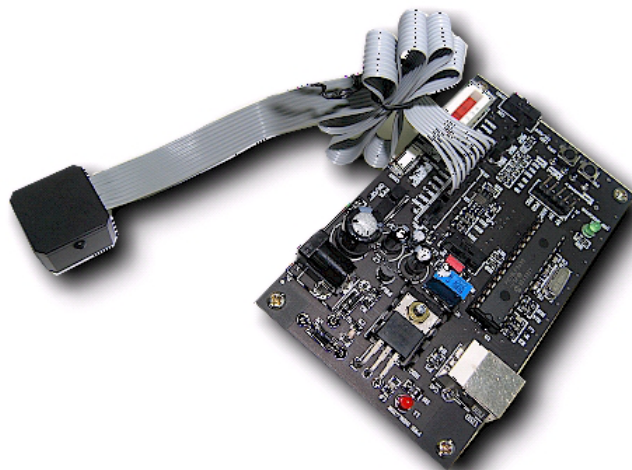

User Guide



Contents:

Disclaimer, Warning, Credit	2
1.0 Introduction	3
2.0 Startup	3
3.0 Color Sensor Module	4
3.1 Digital Color Sensor Controller Board	5
4.0 Hardware Setup & Configuration	7
5.0 PC Software Description	9

Copyright © 2005 Avago Technologies, Inc. All Rights Reserved.

Avago grants you ("Licensee") a non-exclusive, royalty free, license to use this software in binary code form.

WARNING: This product is non RoHS compliant

Disclaimer, Warning & Credits

Disclaimer

TO THE EXTENT ALLOWED BY LOCAL LAW, THIS SOFTWARE IS PROVIDED TO YOU 'AS IS' WITHOUT WARRANTIES OR CONDITIONS OF ANY KIND, WHETHER ORAL OR WRITTEN, EXPRESS OR IMPLIED. AVAGO SPECIFICALLY DISCLAIMS ANY IMPLIED WARRANTIES OR CONDITIONS OF MERCHANTABILITY, SATISFACTORY QUALITY, NON-INFRINGEMENT AND FITNESS FOR A PARTICULAR PURPOSE. SOME JURISDICTIONS DO NOT ALLOW EXCLUSIONS OF IMPLIED WARRANTIES OR CONDITIONS, SO THE ABOVE EXCLUSION MAY NOT APPLY TO YOU. YOU MAY HAVE OTHER RIGHTS THAT VARY ACCORDING TO LOCAL LAW.

TO THE EXTENT ALLOWED BY LOCAL LAW, IN NO EVENT WILL AVAGO OR ITS SUBSIDIARIES, AFFILIATES OR SUPPLIERS BE LIABLE FOR DIRECT, SPECIAL, INCIDENTAL, CONSEQUENTIAL OR OTHER DAMAGES (INCLUDING LOST PROFIT, LOST DATA, OR DOWNTIME COSTS), ARISING OUT OF THE USE, INABILITY TO USE, OR THE RESULTS OF USE OF THE SOFTWARE, WHETHER BASED IN WARRANTY, CONTRACT, TORT OR OTHER LEGAL THEORY, AND WHETHER OR NOT ADVISED OF THE POSSIBILITY OF SUCH DAMAGES.

YOUR USE OF THE SOFTWARE IS ENTIRELY AT YOUR OWN RISK. SOME JURISDICTIONS DO NOT ALLOW THE EXCLUSION OR LIMITATION OF LIABILITY FOR DAMAGES, SO THE ABOVE LIMITATION MAY NOT APPLY TO YOU. THIS DEVELOPMENT KIT IS A FAMILIARIZATION KIT AND IT IS FOR EVALUATION PURPOSE ONLY. IT IS NOT SUBJECT TO RELIABILITY ASSESSMENT AND AVAGO IS NOT LIABLE.

Warning

DO NOT CONNECT OR DISCONNECT ANYTHING WHILE THE HDJD-JD05 DEVELOPMENT KIT OR THE PC IS SWITCHED ON!!! Doing so anyway may damage your PC and/or the HDJD-JD05 Development Kit permanently. Make sure power is off while interfacing with the Controller Board. DO NOT & never switch off power from controller board while program is running.

Credits

CIE xy chart – Prof. Geoff Hoffman (<http://www.fhoemden.de/~hoffmann/>)

Windows™ is a trademark of Microsoft Corporation.

I2C is a trademark of Royal Philips Electronics.

Other trademarks are the property of their respective owners and are hereby acknowledged.

1.0 Introduction

Avago Technologies has introduced a CMOS digital color sensor that can be directly interfaced to a microcontroller without the need for additional components. ADJD-S313-QR999 digital color sensor is easily interfaced to the system microcontroller via the sensor's 2-wire serial interface.

The color sensor is supplied in a 20-pin QFN (quad flat no lead) package and, measuring 5 x 5 x 0.75-mm is one of the thinnest available in the market. The device operates from a 2.6 V supply voltage, providing significantly lower power consumption for portable devices. The sensor is suitable for use in a variety of portable applications including mobile phones, MP3 players, and PDAs, where it can be used in conjunction with a white LED for reflective color measurement. Other applications include color measurement in portable medical instruments and color detectors and readers.

The Avago sensor development kit, HDJD-JD05 is used as a guide to the application of ADJD-S313 besides demonstrating the principle of color sensing. The color sensor can be used for both transmissive and reflective sensing.

A reflective color sensing system comprises of three main elements namely illuminant, non-emissive object and observer/sensor. The illuminant, as the name implies, will illuminate the object under observation and the reflected light will be captured by the system's sensor. The resultant color information will be governed by the illuminant spectrum, object surface reflectance and sensor/observer spectral response.

Unlike reflective color sensing system, a transmissive color sensing system only comprises of two elements namely observer/sensor and emissive object. The light emitted from the object will be captured by the system's sensor. The resultant color information will be governed by the emission spectrum and sensor/observer spectral response.

Avago HDJD-JD05 serves an exemplary circuit application for composing other simple reflective and transmissive color detection system with Avago digital color sensor.

2.0 Startup

Include in delivery

Standard Avago HDJD-JD05 includes the following components:

- One sensor module
- One Controller Board (CB)
- One power adaptor
- One USB cable
- One CD with installation software

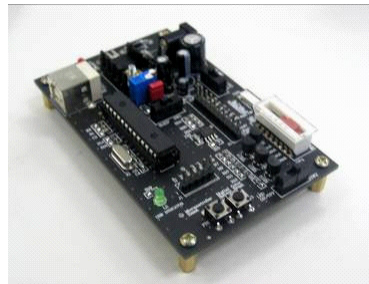

Digital Color Sensor Controller Board



Sensor Module



AC Power Adaptor



USB cable



CD with installation software

3.0 Color Sensor Module

The color sensor module comprises an illuminant, digital color sensor and the mechanical block. The Avago white LED (HSMW-C191) is used as the illuminant/light source and digital color sensor (ADJD-S313-QR999) as the detector. The mechanical block not only acts as the casing but also features an alignment gauge for maintaining an optimum gap between sensor and the targeted surface.

The ADJD-S313-QR999 is a cost effective, CMOS digital output RGB color sensor in miniature surface-mount package with a mere size of 5x5x0.75mm. The color sensor's basic architecture comprises integrated RGB filters built on a uniformly distributed photodiode array, a logic control core, and a gain selector with an ADC that supports digital communication. The uniform RGB filters and photodiode array minimize the effect of light-gradients caused by optical misalignment and irregularity of surfaces.

The output allows direct interface to micro-controller or other logic control for further signal processing without the need of any additional components. With its wide sensing range, the sensor can be used for many applications with different light levels, simply by adjusting the gain setting. Sensitivity control is performed by the serial interface and can be optimized individually for the different color channel. The integrated ADC helps to remove unwanted noise caused by analog signal preconditioning. Additional features include a selectable sleep mode to minimize current consumption when the sensor is not in use. For more details of ADJD-S313-QR999 specifications, please refer to the datasheet which can be downloaded at www.avagotech.com.

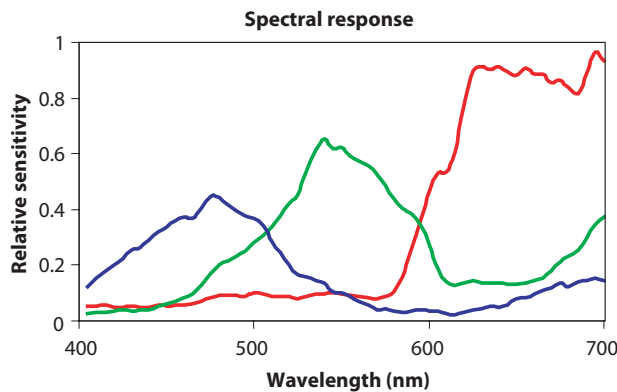

Figure 3.0: ADJD-S313 Spectral Response

Reflective Color Sensing Theory of Operation

By definition of reflective sensing, the color sensor detects light reflected from a surface or an object. The sensor module is designed in such a way that both the light source and the color sensor are placed close to the target surface/object. Light coming from the LED is bounced off a surface/object and measured by the sensor. For a given light source, the color of light reflected off a surface/object is a function of the surface/object color. For example, white light incident onto a red surface is reflected as red. Since any color is uniquely represented by its **R**, **G** and **B** components, the sensor module effectively measures the color of a surface/object by converting the **R**, **G** and **B** components of the reflected light to digital value. In addition, given that the outputs increase linearly with the intensity of reflected light, the sensor also measures the reflectivity of a surface/ object.

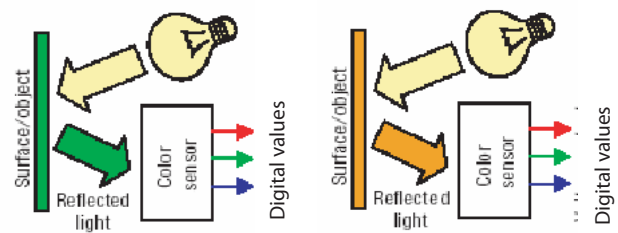

Figure 3.1: For a given light source, the color of reflected depends on surface/object color

Transmissive Color Sensing Theory of Operation

By transmissive, it means the application kit is placed facing the light source being measured. The filter-coated photodiode array of the color sensor converts the **R, G, B** components of light falling on it into photocurrent, which is then converted into digital values for each of the primary component. Given that any colored light is uniquely represented by the ratio of the primary colors, the color sensor provides a definite manner of measuring color. In addition, the sensor is also responsive to light intensity where its outputs increase linearly with increasing light intensity. For a given light source, the application kit can also be used to determine the color of transparent medium through which the light is passed before reaching the sensor. For example, the medium could be glass, plastic or liquid.

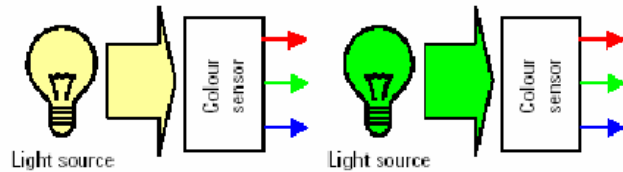

Figure 3.2: R, G, B outputs of the sensor is determined by color of light falling on the sensor

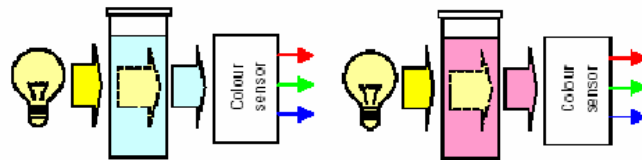

Figure 3.3: Apply color sensor on media such as color filter, gas or liquid

To use HDJD-JD05 in transmissive mode, the white LED should be turn off with the slider switch at the digital color sensor controller board.

3.1 Digital Color Sensor Controller Board

The digital color sensor controller board consists of the following modules:

- (i) 2-wire Serial Interface to USB Converter Module
- (ii) Power Supply Module
- (iii) LED Constant Current Module
- (iv) Digital Color Sensor Reset and Sleep Module

2-wire Serial Interface to USB Converter Module

This module converts the 2-wire serial interface from the digital color sensor to USB protocol that can be easily interface with the computer. The main components of this module are dual bidirectional bus buffer, P82B96 and USB microcontroller, PIC18F2455. The P82B96 interface the two different logic level from the microcontroller (5V) and digital color sensor (2.6V) while the microcontroller interface the 2 wire serial to USB.

See figure 3.4

Power Supply Module

The power supply module taps power from the adapter and provides regulated voltage 5V for the microcontroller and 2.6V for the digital color sensor.

See figure 3.5



Figure 3.4: 2-wire serial interface to USB Converter Block Diagram

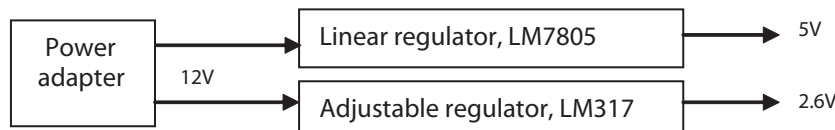

Figure 3.5: Power Module Block Diagram

LED Constant Current Module

This module provides four selectable current 5mA, 10mA, 15mA and 20mA to the white LED.

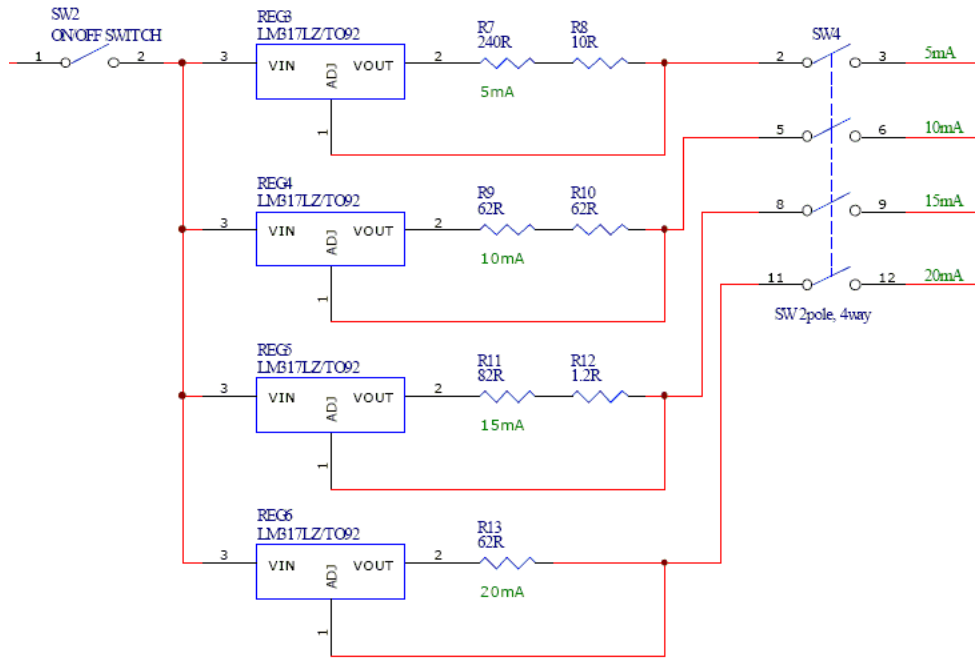

Figure 3.6: LED Constant Current Block Diagram

Digital Color Sensor Reset and Sleep Module

Consists reset and sleep circuit for digital color sensor.

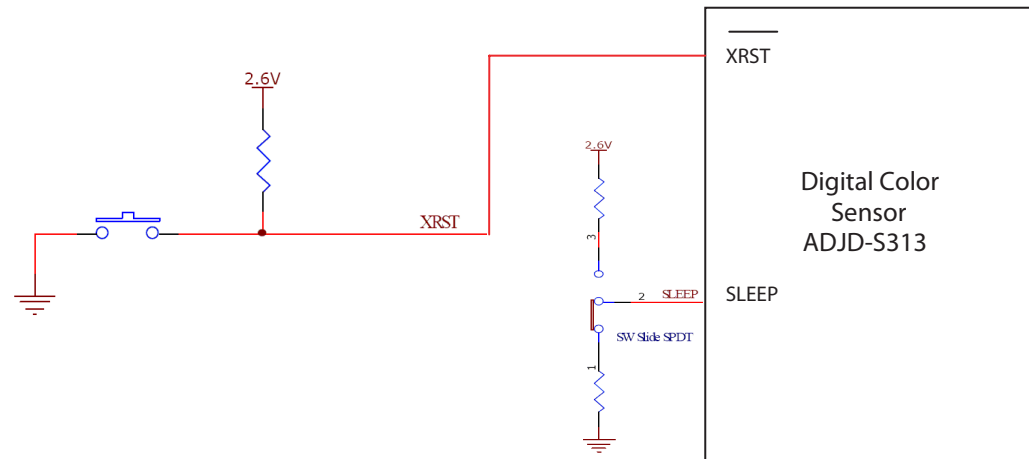

Figure 3.7: Digital Color Sensor Reset and Sleep Block Diagram

4.0 Hardware Setup & Configuration

Setup:

1. Connect the power adapter to the adapter socket.
Precaution: The demo is tested working properly with the AC adapter provided. Avago Technologies shall not be liable to any improper operation of demo with other types of AC adapter.
2. Connect the USB cable from the computer to the controller board.
3. Connect the sensor module to the controller board. Make sure the orientation is correct by looking at the label 'Pin 1' on the cable is actually connected to label J3 at the board. Also notice that pin 10 that is without cable is connected to NC.

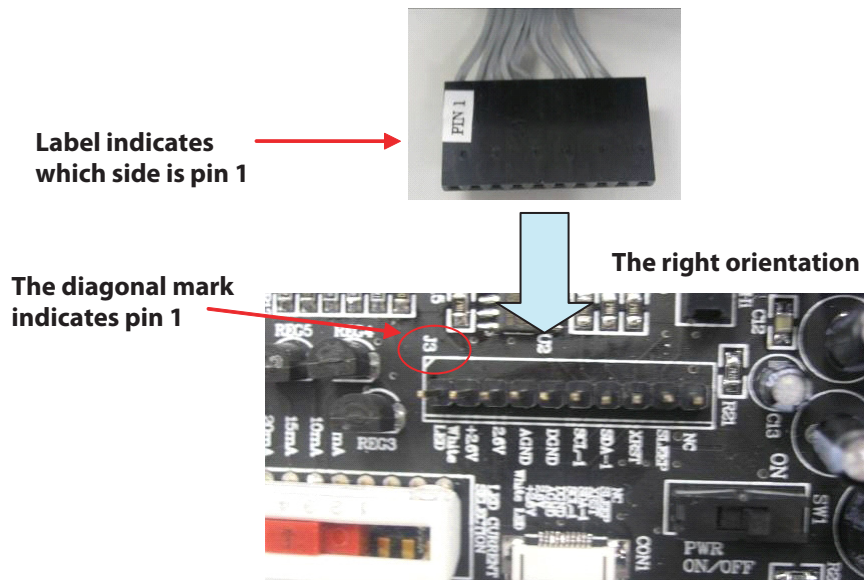

Figure 4.0: The right orientation to connect the sensor module to controller board

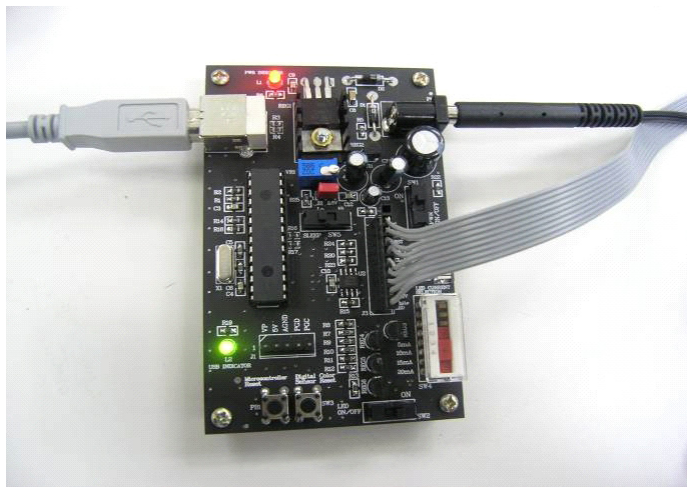

Figure 4.1: Controller board with all interface connected

To power on:

1. Turn on the power switch (SW1). The red LED will light up to indicate there is power supply to the board.
2. The green LED will light up if the USB cable is connected indicating there are communication between the controller board and the computer.
3. Make sure the jumper (J2) is connected to supply 2.6V to the sensor.
4. Make sure the Sleep switch (SW5) is at the 'lo' position for sensor normal operation.

Note: You can switch it to 'hi' later if you want to put the sensor in sleep mode to minimize power consumption when sensor not in use.

J2: Jumper for 2.6V supply

SW5: Sleep switch



Lo Hi

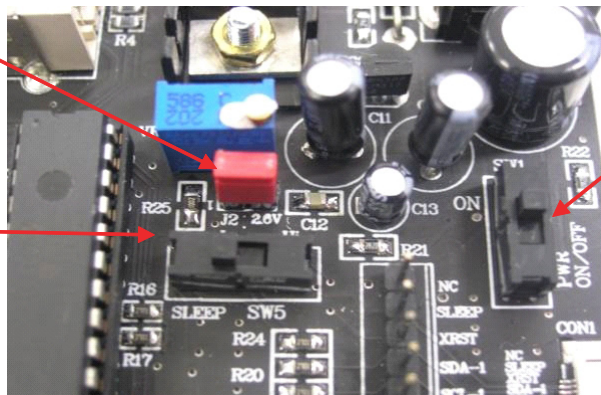

SW1: Power switch

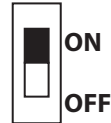
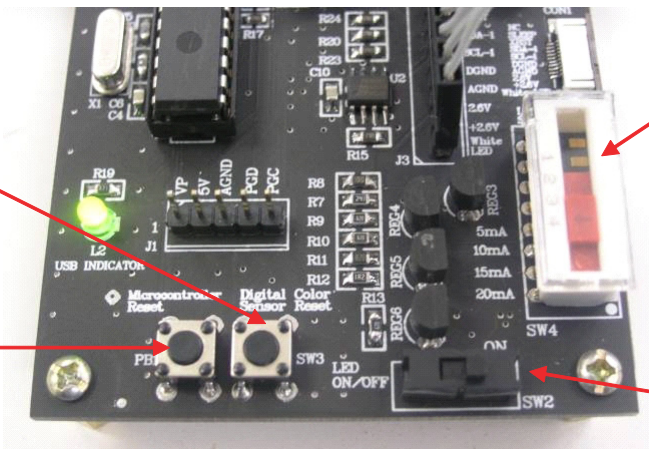

Figure 4.2

Other switches:

Press SW3 to reset color sensor

Press PB1 to reset microcontroller



To select white LED current.

- 1 - 5mA
- 2 - 10mA
- 3 - 15mA
- 4 - 20mA

SW2: LED switch



OFF ON

Figure 4.3: Other switches

5.0 PC Software Description

Avago Digital Color Sensor Development Kit software (DCS) is developed to be a tool for user to acquire knowledge on how to use ADJD-S313 and how color sensor can be applied. This software further elaborates the steps stated in ADJD-S313 application note, which can be downloaded from www.avagotech.com. The interactive graphical user interface has made the software to be user friendly and easy to use. This software allow user to use a step by step mode to configure and operate the sensor for learning purpose. The user can also prompt for the easy access features which allow the user to operate the sensor with just 'one click'.

Software Installation

To install the software to the PC:

1. Insert the installation CD to the CD-ROM drive
2. Click **Start**, then click **Run**
3. Type **D:\setup** and press Enter.

IMPORTANT: Use the appropriate drive letter in the above command to install the software. CD-ROMs are commonly "D:".

The installation program will guide you through the software installation.

How to use the software

For the instructions on how to use the software, please refer to the HDJD-JD05 Software User Guide which is also available in the CD.

For product information and a complete list of distributors, please go to our web site: www.avagotech.com

Avago, Avago Technologies, and the A logo are trademarks of Avago Technologies, Limited in the United States and other countries.
Data subject to change. Copyright © 2006 Avago Technologies Pte. All rights reserved.
AV01-0357EN - July 4, 2007

