

## Data Sheet



Lead (Pb) Free  
RoHS 6 fully  
compliant



### Description

This family of SMT LEDs is packaged in the industry standard PLCC-4 package. These SMT LEDs have high brightness and reliability performance and are designed to work under a wide range of environmental conditions. This high reliability feature makes them ideally suited to be used under exterior and interior full color signs application conditions.

To facilitate easy pick & place assembly, the LEDs are packed in EIA-compliant tape and reel. Every reel will be shipped in single intensity and color bin; except red color to provide close uniformity.

These LEDs are compatible with IR soldering process.

This super wide viewing angle at 120° together with the built in reflector pushing up the intensity of the light output makes these LED suitable to be used in the interior electronics signs. The flat top emitting surface makes it easy for these LEDs to mate with light pipes. This is suitable for general backlighting in automotive interior, office equipment, industrial equipment, and home appliances.

### Features

- Industry Standard PLCC-4 package
  - (Plastic Leaded Chip Carrier)
- High reliability LED package due to enhanced silicone resin material
- High brightness using AlInGaP and InGaN dice technologies
- Super wide viewing angle at 120°
- Available in 8mm carrier tape on 7-inch reel
- Compatible with IR soldering process
- Black surface RGB PLCC-4 for higher contrast
- JEDEC MSL 2a

### Applications

- Electronic Signs and Signals
  - Exterior and Interior Full Color Sign
  - Variable Message Sign
- Interior automotive
  - Instrument cluster backlighting
  - Central console backlighting
  - Cabin backlighting
- Office automation, Home appliances, Industrial Equipment
  - Front panel backlighting
  - Display backlighting

**CAUTION:** ASMT-QTB2-xxxxx LEDs are Class 1C ESD sensitive. Please observe appropriate precautions during handling and processing. Refer to Avago Application Note AN-1142 for additional details.

## Package Dimensions

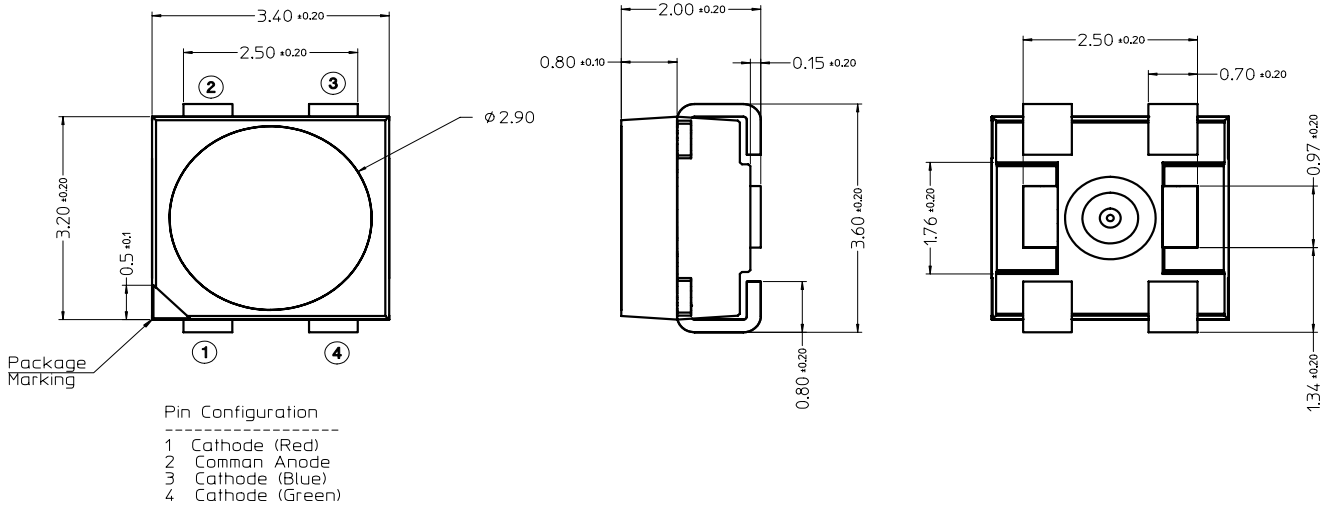

### Notes:

1. All Dimensions are in millimeters.
2. Tolerance =  $\pm 0.2$  mm unless otherwise specified.
3. Terminal Finish: Ag plating
4. Encapsulation material: Silicone resin

## Lead Configuration

1	Cathode	Red
2	Common Anode	
3	Cathode	Blue
4	Cathode	Green

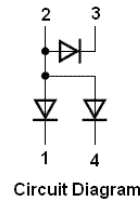

Figure 1. Package Drawing

## Table 1. Device Selection Guide

### Tri Color

Part Number	Color 1	Color 2	Color 3
ASMT-QTB2-0xxxx	AlInGaP Red	InGaN Green	InGaN Blue

Part Number	Color 1			Color 2			Color 3		
	Bin ID	Min. Iv @ 20mA (mcd)	Typ. Iv @ 20mA (mcd)	Bin ID	Min. Iv @ 20mA (mcd)	Typ. Iv @ 20mA (mcd)	Bin ID	Min. Iv @ 20mA (mcd)	Typ. Iv @ 20mA (mcd)
ASMT-QTB2-0A002	T2	355	505	V1	715	1015	S2	224	325

### Notes:

1. The luminous intensity IV, is measured at the mechanical axis of the lamp package. The actual peak of the spatial radiation pattern may not be aligned with this axis.
2. Tolerance =  $\pm 12$  %

## Part Numbering System

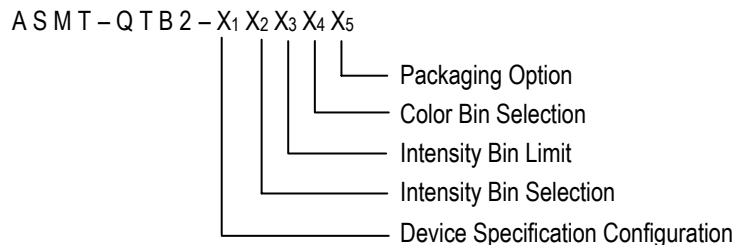

**Table 2. Absolute Maximum Ratings (Ta = 25°C)**

Parameter	Red	Green & Blue	Unit
DC forward current <sup>[1]</sup>	50	30	mA
Peak forward current <sup>[2]</sup>	100	300	mA
Power dissipation	130	117	mW
Reverse voltage		4V	V
Maximum junction temperature T <sub>j max</sub>		125	°C
Operating board temperature, T <sub>a</sub> range		- 40 to + 110	°C
Storage temperature range		- 40 to + 110	°C

Note:

1. Derate Linearly as shown in Figure 5a & 5b.
2. Duty Factor = 0.5%, Frequency = 500Hz

**Table 3. Optical Characteristics (Ta = 25°C)**

Color	Dice Technology	Dominant Wavelength, λ <sub>d</sub> (nm) <sup>[1]</sup>	Peak Wavelength, λ <sub>p</sub> (nm)	Viewing Angle, 2θ <sub>1/2</sub> <sup>[2]</sup> (Degrees)	Luminous Efficacy, η <sub>v</sub> <sup>[3]</sup> (lm/W)	Luminous Efficiency, η <sub>e</sub> (lm/W)	Luminous Intensity / Total Flux, <sup>[4]</sup> I <sub>v</sub> (cd) / Φ <sub>v</sub> (lm)
		Typ.	Typ.	Typ.	Typ.	Typ.	Typ.
Red	AllInGaP	628	639	120	160	30	0.35
Green	InGaN	526	519	120	530	45	0.35
Blue	InGaN	472	467	120	70	15	0.35

Notes:

1. The chromaticity coordinates and dominant wavelength are derived from the CIE Chromaticity Diagram and represent the perceived color of the device. The values are average for all LEDs in the product.
2. The total spectral width at 1/2 of the peak intensity for all LEDs of a specific color.
3. Radiant intensity, I<sub>e</sub> in watts / steradian, may be calculated from the equation I<sub>e</sub> = I<sub>v</sub> / η<sub>v</sub>, where I<sub>v</sub> is the luminous intensity in candelas and η<sub>v</sub> is the luminous efficacy in lumens / watt.
4. Φ<sub>v</sub> is the total luminous flux output as measured with an integrating sphere at mono pulse conditions.

**Table 4. Electrical Characteristics (Tj = 25°C)**

Color	Forward Voltage V <sub>F</sub> (V) <sup>[1]</sup>		Reverse Voltage V <sub>R</sub> @ 100μA	Reverse Voltage V <sub>R</sub> @ 10μA	Thermal Resistance Rθ <sub>J-P</sub> (°C/W)
	Typ.	Max.	Min.	Min.	Typ.
Red	2.06	2.60	4	-	95
Green	3.32	3.90	-	4	70
Blue	3.32	3.90	-	4	60

Note:

1. Tolerance ± 0.1V.

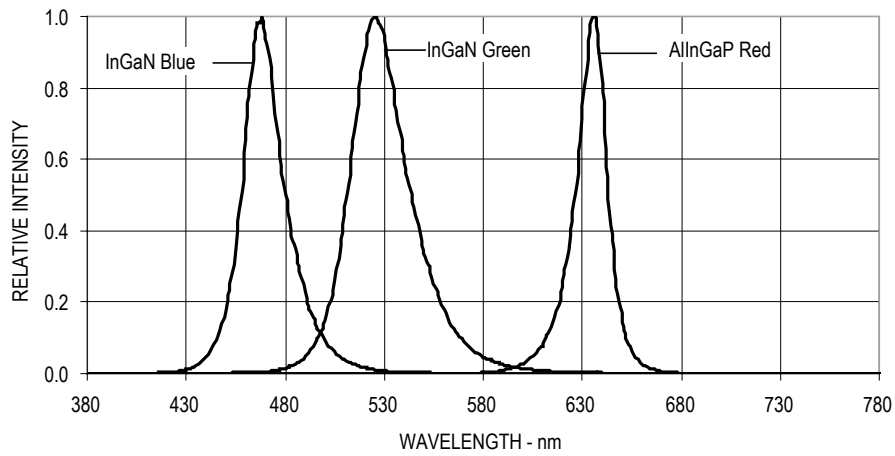

Figure 2. Relative intensity vs. wavelength

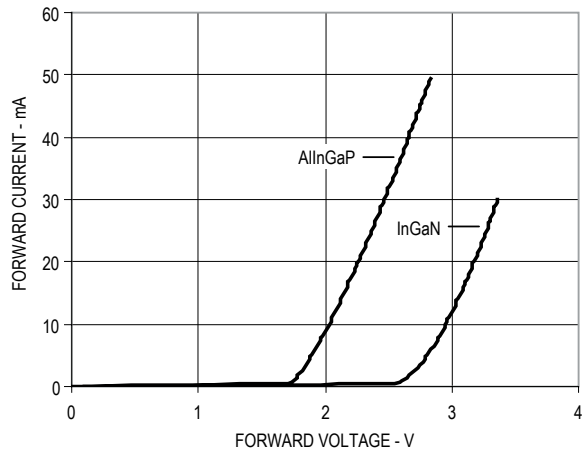

Figure 3. Forward current vs. forward voltage

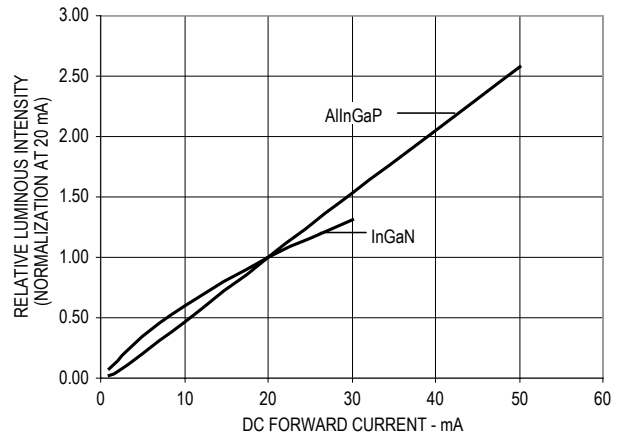

Figure 4. Relative Intensity vs. forward current

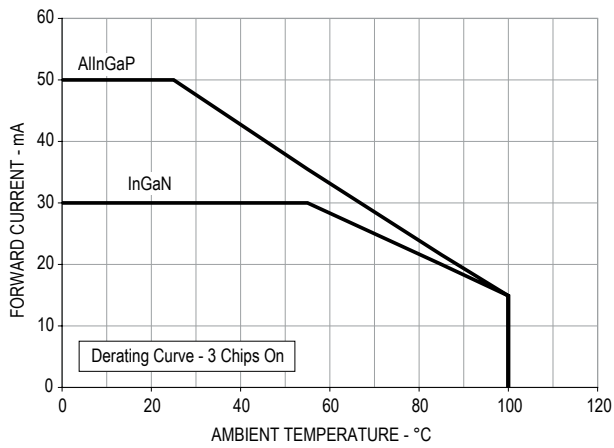

Figure 5a. Maximum forward current vs. ambient temperature. Derated based on  $T_{JMAX} = 125^{\circ}C$ ,  $R_{\theta JA} = 600^{\circ}C/W$  (3 chip on).

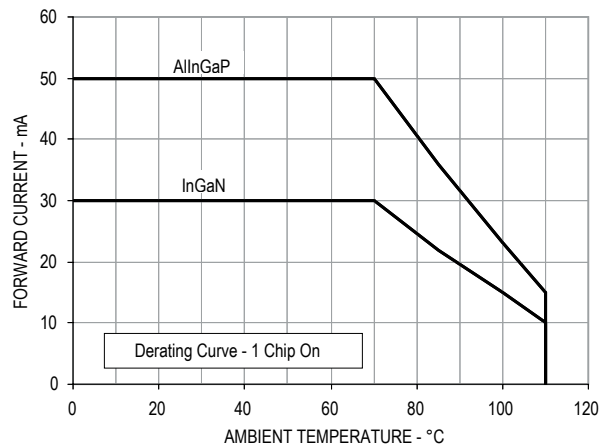

Figure 5b. Maximum forward current vs. ambient temperature. Derated based on  $T_{JMAX} = 125^{\circ}C$ ,  $R_{\theta JA} = 340^{\circ}C/W$  (1 chip on).

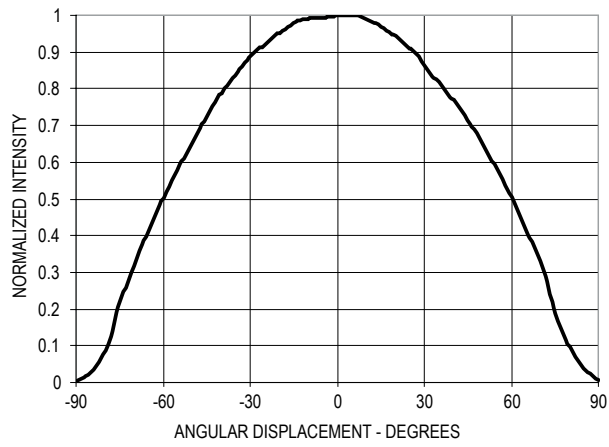

Figure 6. Radiation pattern.

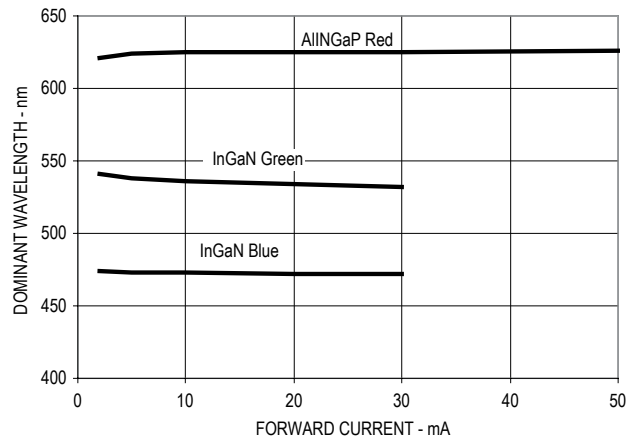

Figure 7. Dominant wavelength vs. forward current

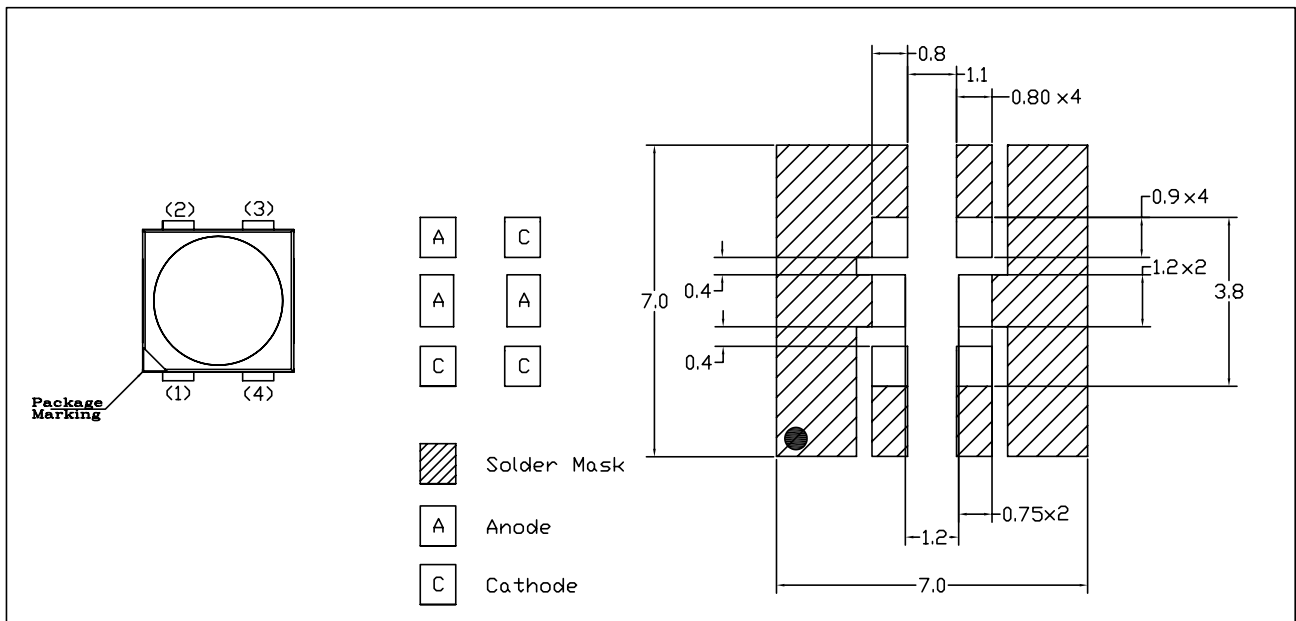
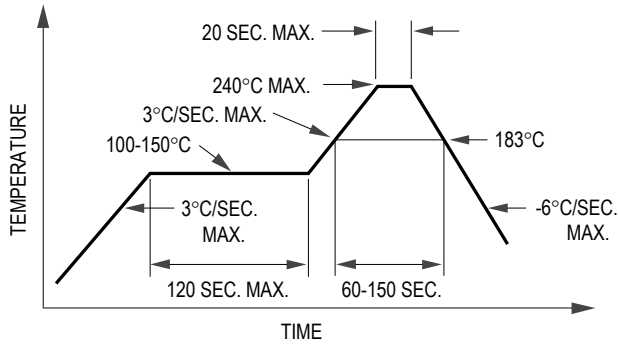
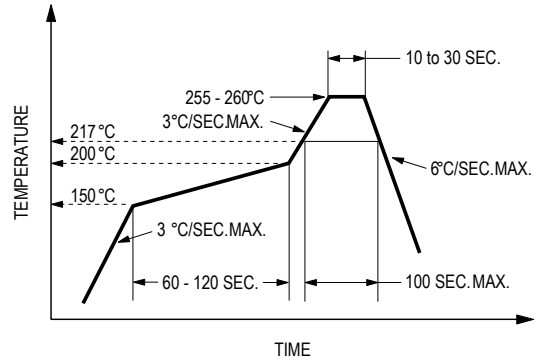

Figure 8. Recommended soldering land pattern.

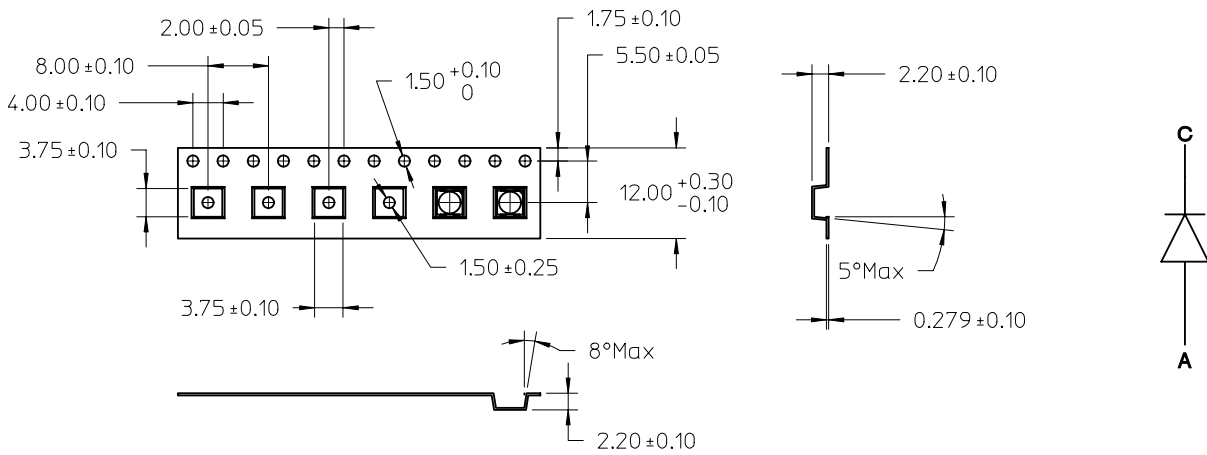

**Figure 9. Recommended leaded reflow soldering profile.**

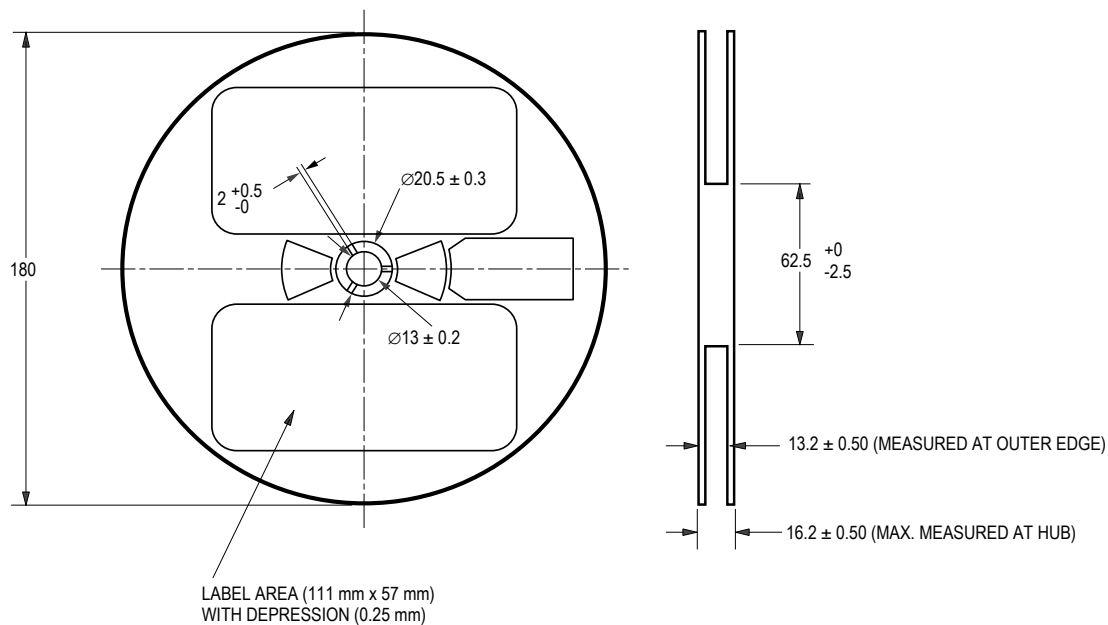

**Figure 10. Recommended Pb-free reflow soldering profile.  
(Acc. To J-STD-020C)**

Note: For detail information on reflow soldering of Avago surface mount LEDs, do refer to Avago Application Note AN 1060 Surface Mounting SMT LED Indicator Components.



**Figure 11. Carrier Tape Dimension**



**Figure 12. Reel Dimension.**

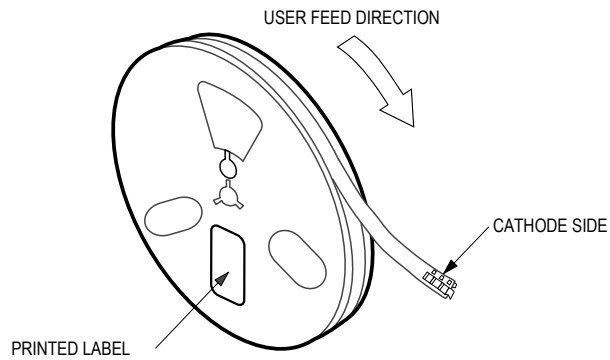

**Figure 13. Reeling Orientation.**

## Moisture Sensitivity

This product is qualified as Moisture Sensitive Level 2a per Jedec J-STD-020. Precautions when handling this moisture sensitive product is important to ensure the reliability of the product. Do refer to Avago Application Note AN5305 Handling of Moisture Sensitive Surface Mount Devices for details.

### A. Storage before use

- Unopen moisture barrier bag (MBB) can be stored at <math><40^{\circ}\text{C}/90\%\text{RH}</math> for 12 months. If the actual shelf life has exceeded 12 months and the HIC indicates that baking is not required, then it is safe to reflow the LEDs per the original MSL rating.
- It is not recommended to open the MBB prior to assembly (e.g. for IQC).

### B. Control after opening the MBB

- The humidity indicator card (HIC) shall be read immediately upon opening of MBB.
- The LEDs must be kept at <math><30^{\circ}\text{C} / 60\%\text{RH}</math> at all time and all high temperature related process including soldering, curing or rework need to be completed within 672 hours.

### C. Control for unfinished reel

- For any unuse LEDs, they need to be stored in sealed MBB with desiccant or desiccator at <math><5\%\text{RH}</math>.

### D. Control of assembled boards

- If the PCB soldered with the LEDs is to be subjected to other high temperature processes, the PCB need to be stored in sealed MBB with desiccant or desiccator at <math><5\%\text{RH}</math> to ensure no LEDs have exceeded their floor life of 672 hours.

### E. Baking is required if:

- "10%" or "15%" HIC indicator turns pink.
- The LEDs are exposed to condition of <math>>30^{\circ}\text{C} / 60\%\text{RH}</math> at any time.
- The LEDs floor life exceeded 672 hours.

Recommended baking condition:  $60\pm 5^{\circ}\text{C}$  for 20 hours.

## Intensity Bin Select (X<sub>2</sub>X<sub>3</sub>)

Individual reel will contain parts from 1 half bin only

For ASMT-QTB2-0xxxx

X <sub>2</sub>	Min Iv Bin (Minimum Intensity Bin)		
	Color 1 (Red)	Color 2 (Green)	Color 3 (Blue)
0	0	0	0
A	T2	V1	S2
B	T2	V1	T1
C	T2	V1	T2
D	T2	V1	U1
E	T2	V2	S2
F	T2	V2	T1
G	T2	V2	T2
H	T2	V2	U1
J	T2	W1	S2
K	T2	W1	T1
L	T2	W1	T2
M	T2	W1	U1
N	U1	V1	S2
P	U1	V1	T1
Q	U1	V1	T2
R	U1	V1	U1
S	U1	V2	S2
T	U1	V2	T1
U	U1	V2	T2
V	U1	V2	U1
W	U1	W1	S2
X	U1	W1	T1
Y	U1	W1	T2
Z	U1	W1	U1
1	U2	V1	S2
2	U2	V1	T1
3	U2	V1	T2
4	U2	V1	U1
5	U2	V2	S2
6	U2	V2	T1
7	U2	V2	T2
8	U2	V2	U1

X <sub>3</sub>	Number of Half bins from X <sub>2</sub>		
	Color 1 (Red)	Color 2 (Green)	Color 3 (Blue)
0	0	0	0
A	4	4	4
B	4	4	3
C	4	4	2
D	4	3	4
E	4	3	3
F	4	3	2
G	4	2	4
H	4	2	3
J	4	2	2
K	3	4	4
L	3	4	3
M	3	4	2
N	3	3	4
P	3	3	3
Q	3	3	2
R	3	2	4
S	3	2	3
T	3	2	2
U	2	4	4
V	2	4	3
W	2	4	2
X	2	3	4
Y	2	3	3
Z	2	3	2
1	2	2	4
2	2	2	3
3	2	2	2
9	Special		

Note: 0 represents no maximum bin limit



### Intensity Bin Limits

Bin ID	Min (mcd)	Max (mcd)
S2	224.00	285.00
T1	285.00	355.00
T2	355.00	450.00
U1	450.00	560.00
U2	560.00	715.00
V1	715.00	900.00
V2	900.00	1125.00
W1	1125.00	1400.00
W2	1400.00	1800.00
X1	1800.00	2240.00
X2	2240.00	2850.00
Y1	2850.00	3550.00

Tolerance of each bin limit =  $\pm 12\%$

### Color Bin Select (X<sub>4</sub>)

Individual reel will contain parts from 1 full bin only

For ASMT-QTB2-xxxxx

X <sub>4</sub>	Color Bin Combinations		
	Color 1	Color 2	Color 3
0	0	0	0

### Color Bin Limits

Blue	Min (nm)	Max (nm)
B	465.0	470.0
C	470.0	475.0

Green	Min (nm)	Max (nm)
C	525.0	530.0
D	530.0	535.0

Red	Min (nm)	Max (nm)
Full Distribution	620.0	630.0

Tolerance of each bin limit =  $\pm 1\text{nm}$

CIE 1931 - Chromaticity Diagram

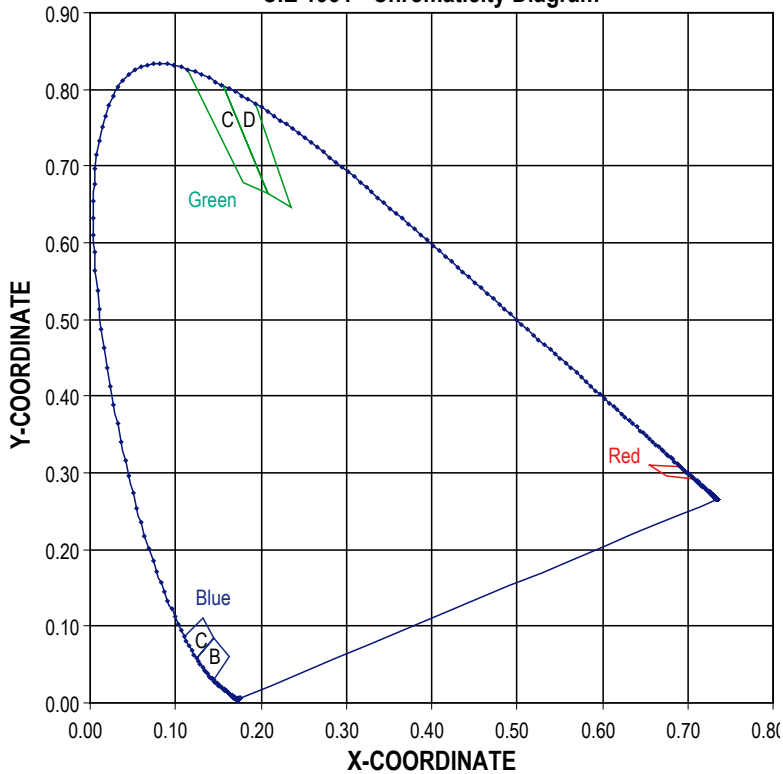

**Packaging Option (X<sub>5</sub>)**

Option	Test Current	Package Type	Reel Size
2	20mA	Top Mount	7 inch

**Handling Precaution**

The encapsulation material of the product is made of silicone for better reliability of the product. As silicone is a soft material, please do not press on the silicone or poke a sharp object onto the silicone. These might damage the product and cause premature failure. During assembly of handling, the unit should be held on the body only. Please refer to Avago Application Note AN 5288 for detail information.

For product information and a complete list of distributors, please go to our web site: [www.avagotech.com](http://www.avagotech.com)

Avago, Avago Technologies, and the A logo are trademarks of Avago Technologies, Limited in the United States and other countries. Data subject to change. Copyright © 2007 Avago Technologies Limited. All rights reserved. AV02-0183EN - January 9, 2008

