

AMMC-6550

15 to 50 GHz Image Rejection Mixer

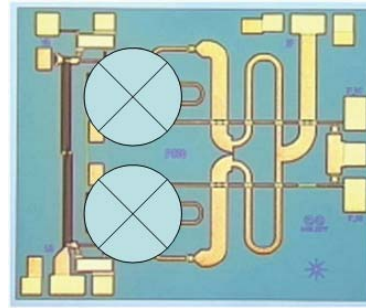

Data Sheet



Chip Size: 1600 x 1300 μm (63 x 51 mils)
Chip Size Tolerance: $\pm 10 \mu\text{m}$ (± 0.4 mils)
Chip Thickness: $100 \pm 10 \mu\text{m}$ (4 ± 0.4 mils)
Pad Dimensions: $100 \times 100 \mu\text{m}$ ($4 \times 4 \pm 0.4$ mils)

Description

AMMC-6550 is an image rejection mixer (IRM), which can also be used as an IQ mixer. The AMMC-6550 utilizes two distributed passive FET mixers and a Lange coupler realized in Avago Technologies unique 0.25 μm gate length Enhancement mode PHEMT (E-PHEMT) technology. Although the AMMC-6550 works as a resistive mixer, the mixer can be biased with a positive DC voltage (+0.4V Typ.).

AMMC-6550 is designed for use in commercial digital radios and wireless LANs. The mixer requires an off-chip 90-degree hybrid to achieve signal image rejection and +0.4V (Typ.) DC bias.

Applications

- Microwave Radio systems
- Satellite VSAT, DBS Up/Down Link
- LMDS & Pt-Pt mmW Long Haul
- Broadband Wireless Access (including 802.16 and 802.20 WiMax)
- WLL and MMDS loops

Features

- Wide frequency range: 15 - 50 GHz
- Low conversion loss: 10 dB (Typ.)
- Image Rejection: 15 dB (Typ.)
- High Input IP3: +20dBm
- Positive polarity for Gate and Drain Bias

Schematic

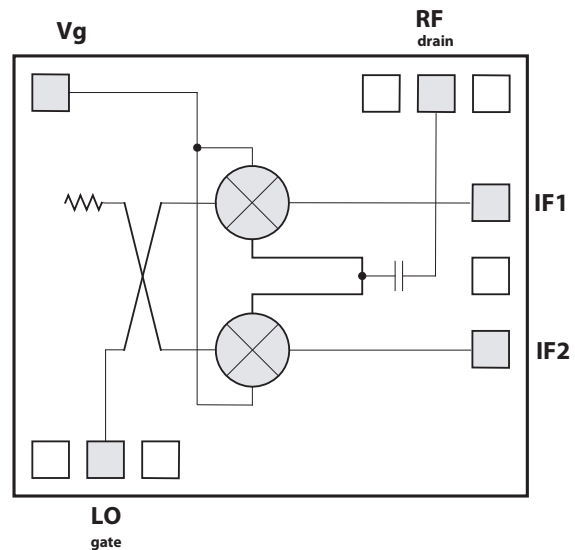

Note: These devices are ESD sensitive. The following precautions are strongly recommended. Ensure that an ESD approved carrier is used when units are transported from one destination to another. Personal grounding is to be worn at all times when handling these devices. The manufacturer assumes no responsibilities for ESD damage due to improper storage and handling of these devices.

AMMC-6550 Maximum Ratings [1]

Symbol	Parameters and Conditions	Units	Minimum	Maximum
V _g	Gate Supply Voltage	V	-1.2	+1.2
P _{in}	CW Input Power (IF and LO port)	dBm		25
T _{ch}	Operating Channel Temperature	°C		+150
T _{stg}	Storage Case Temperature	°C	-65	+150
T _{max}	Max. Assembly Temp (60 sec. max)	°C		+300

Note: 1. Operation in excess of any one of these conditions may result in permanent damage to this device.

AMMC-6550 DC Specifications/Physical Properties [1]

Symbol	Parameters and Test Conditions	Units	Typical
V _g	Gate Supply Operating Voltage	V	+0.4
I _g	Gate Supply Current (under any RF power drive and temperature)	mA	0

Note: 1. Ambient operational temperature T_a=25°C unless otherwise noted.

AMMC-6550 Typical performances (T_A= 25°C, V_g=+0.4 V, IF frequency=1GHz, Z₀=50 Ω)

Symbol	Parameters and Test Conditions	Units	Typical
F _{RF}	RF Frequency Range	GHz	15 - 50
F _{LO}	LO Frequency Range	GHz	15 - 50
F _{IF}	IF Frequency Range	GHz	DC - 5
P _{LO}	Lo port pumping power	dBm	>10
CG	RF to IF conversion gain	dB	-10
RL _{RF}	RF Port Return Loss	dB	-10
RL _{LO}	LO Port Return Loss	dB	-15
RL _{IF}	IF Port Return Loss	dB	-10
IR	Image rejection ratio	dB	15
LO-RF Iso.	LO to RF port Isolation	dB	20
LO-IF Iso.	LO to IF port Isolation	dB	20
RF-IF Iso.	RF to IF port Isolation	dB	15
IIP3	Input IP3, F _{delta} =100MHz, P _{rf} =-10dBm, P _{lo} =15dBm	dBm	20
P-1	Input port power at 1dB gain compression point, P _{lo} =+15dBm	dBm	+10
NF	Noise Figure	dB	10

AMMC-6550 RF Specifications [2, 3, 6, 7] ($T_A=25^\circ\text{C}$, $V_g=+0.4\text{V}$, $P_{lo}=+10\text{dBm}$, $Z_0=50\ \Omega$)

Symbol	Parameters and Test Conditions	Units	LO=17GHz			LO=28GHz			LO=40GHz		
			Min.	Typ.	Max.	Min.	Typ.	Max.	Min.	Typ.	Max.
CG	Conversion Gain [4]	dB	-11.5	-10		-10.5	-9.5		-12	-10.3	
IR	Image Rejection Ratio [5]	dB		-14	-12		-18.6	-12		-17.5	-12

Notes:

- Small/Large signal data measured in a fully de-embedded test fixture from $T_a=25^\circ\text{C}$.
- Specifications are derived from measurements in $50\ \Omega$ test environment.
- 100% on-wafer RF testing is done at RF frequency = 19, 30, and 42GHz; IF frequency = 1GHz.
- 100% on-wafer RF testing is done at RF frequency = 15, 26, and 38GHz; IF frequency = 2GHz.
- The external 90 degree hybrid coupler is from M/A-COM: PN 2032-6344-00. Frequency = 1.0-2.0GHz
- All tested parameters guaranteed with measurement accuracy $\pm 1\text{dB/dBm/dBc}$.

Typical distribution of conversion gain and image rejection ratio based on 5000 parts.

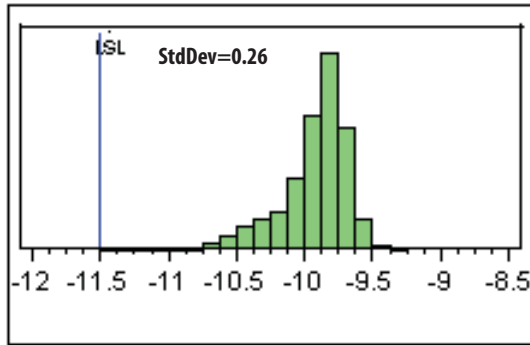

Conversion Gain LO=17GHz, RF=19GHz

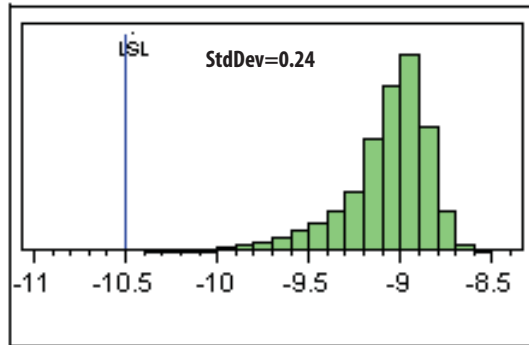

Conversion Gain LO=28GHz, RF=30GHz

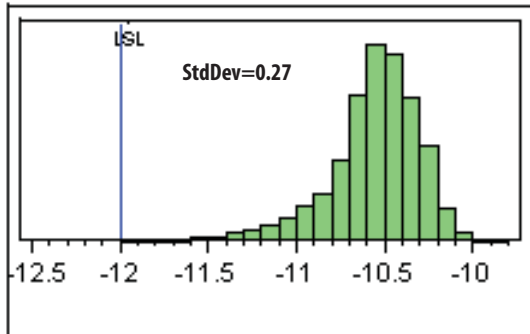

Conversion Gain LO=40GHz, RF=42GHz

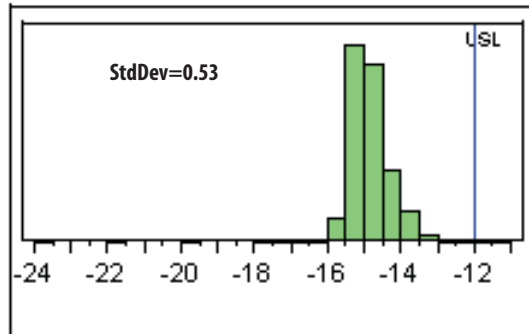

Image Rejection Ratio LO=17GHz, RF=15GHz

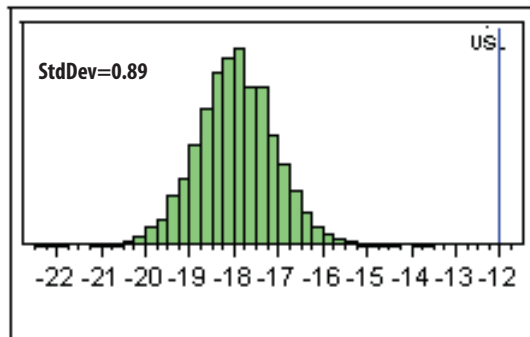

Image Rejection Ratio LO=28GHz, RF=26GHz

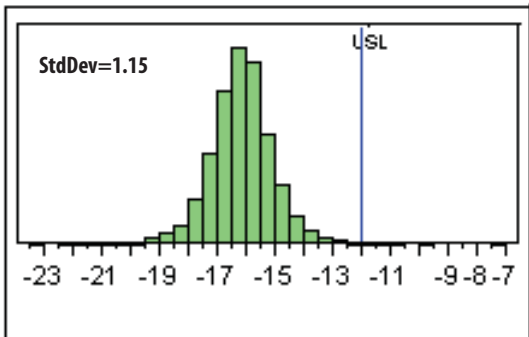

Image Rejection Ratio LO=40GHz, RF=38GHz

Biassing and Operation

The recommended DC bias condition for optimum performance, and reliability is $V_g = +0.4$ volts. There is approximately zero current consumption for the gate biasing because the FET mixer was designed as the passive operation.

Figure 1 is a simple block diagram, as reference for Figure 2. Figure 2 is a schematic of the image-rejection (SSB) mixer MMIC connected to an off-chip quadrature hybrid.

Figures 3 through Figure 11 show typical down conversion measurement results under the image rejection operation. Data presented for the AMMC-6550 was obtained using the circuit described here. Please note that the image rejection and isolation performance is dependent on the selection of the low frequency quadrature hybrid. The performance specification of the low frequency quadrature hybrid as well as the phase balance and VSWR of the interface to the AMMC-6550 will affect the overall mixer performance.

No ground wires are needed since ground connections are made with plated through-holes to the backside of the device.

The AMMC-6550 is not recommended for up conversion applications.

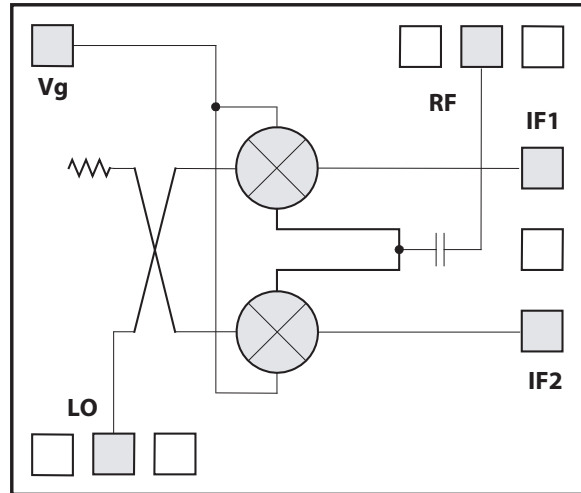

Figure 1. AMMC-6550 Schematic

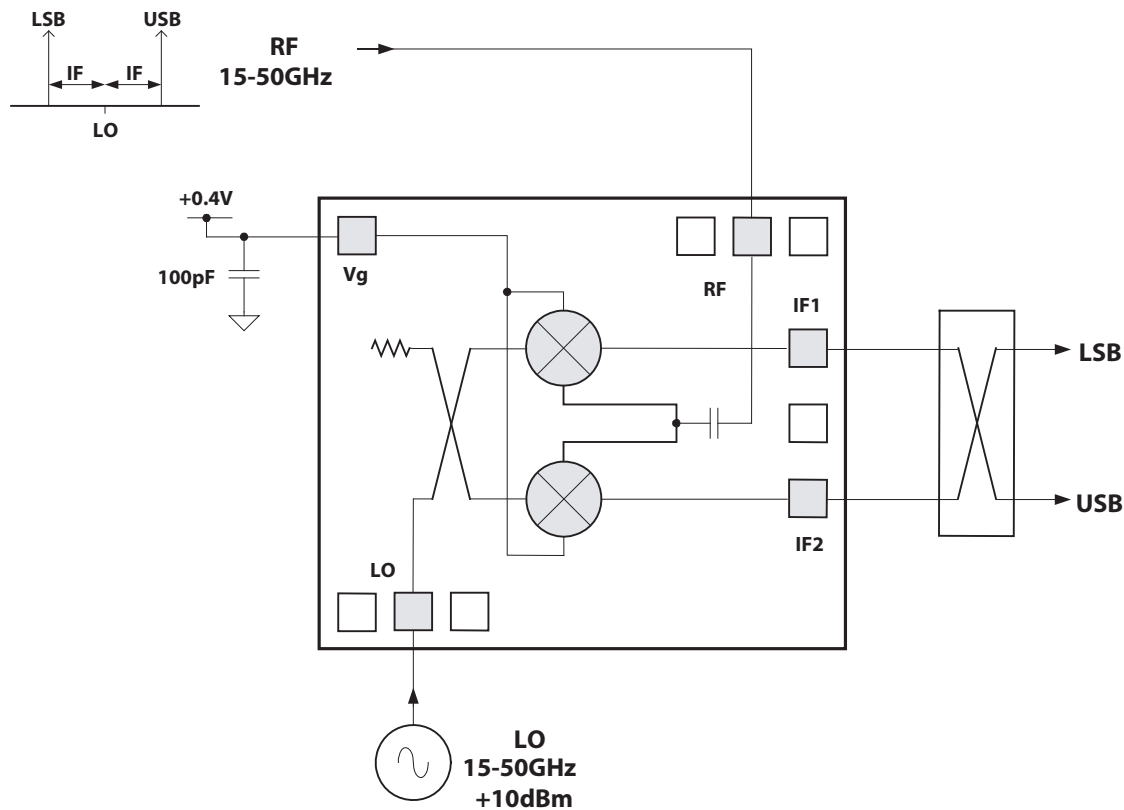

Figure 2. AMMC-6550 Assembly diagram for SSB mixer applications. 50Ω termination is required for the unwanted side-band termination

AMMC-6550 Typical performances ($T_A = 25^\circ\text{C}$, $V_G = +0.4\text{ V}$)

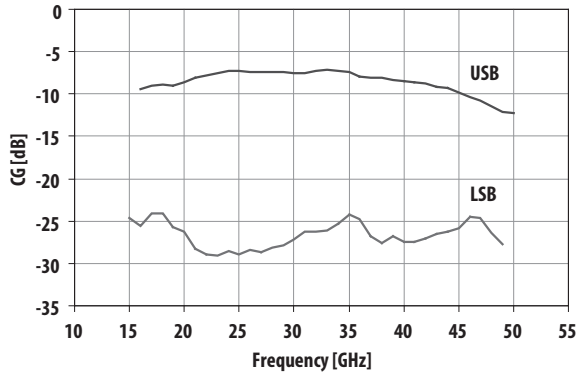

Figure 3. Typical conversion Gain, Plo=+10dBm, IF1=1GHz

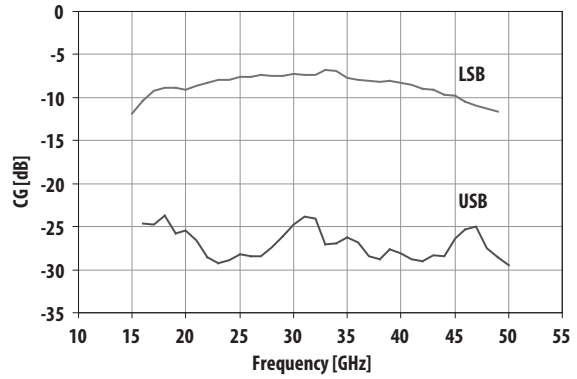

Figure 4. Typical conversion Gain, Plo=+10dBm, IF2=1GHz

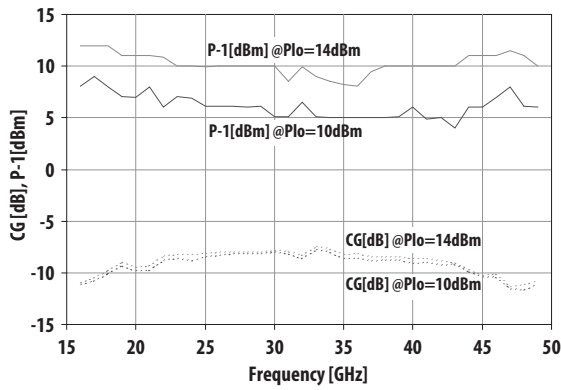

Figure 5. Typical RF port input power (@P-1), Plo=+10dBm, FIF=1GHz

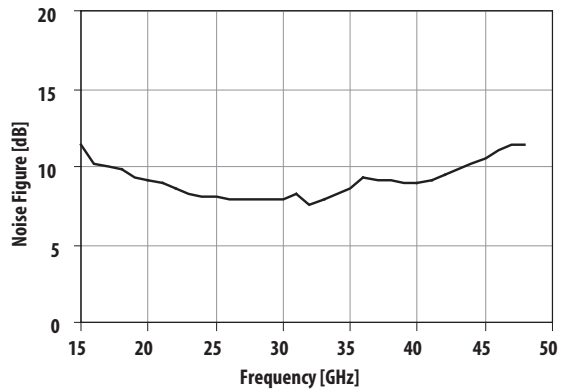

Figure 6. Typical Noise Figure, Plo=10dBm, FIF=1GHz

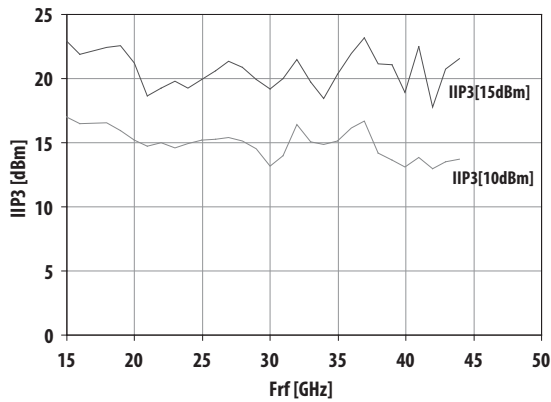

Figure 7. Typical IP3, FIF=1GHz, Plo=10dBm and 15dBm

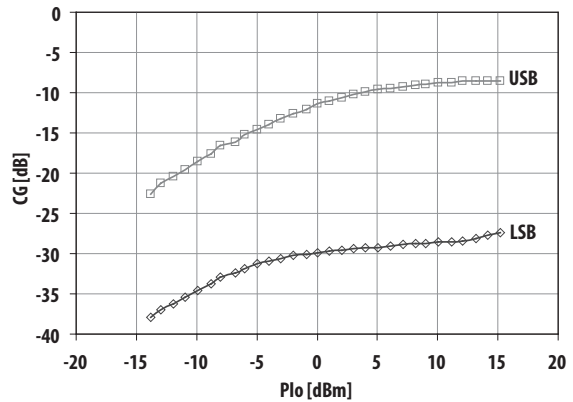

Figure 8. Typical Conversion gain vs. LO power, Prf=-20dBm, and Flo=30GHz

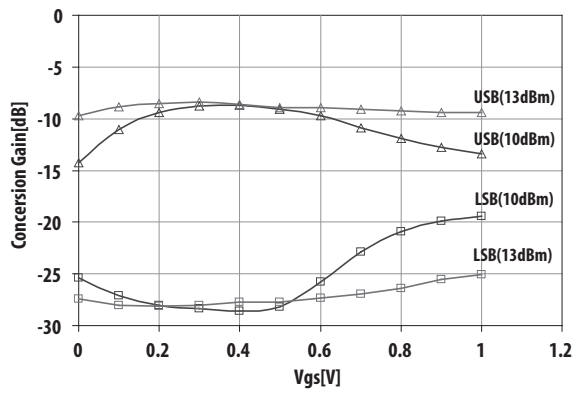

Figure 9. Typical Conversion gain vs. Gate voltage, $F_{lo}=30\text{GHz}$, $P_{lo}=+10\text{dBm}$ and $+13\text{dBm}$

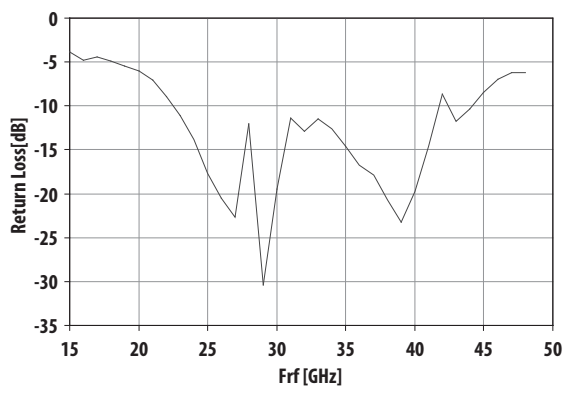

Figure 10. Typical RF port Return Loss vs. Frequency, $P_{lo}=+10\text{dBm}$

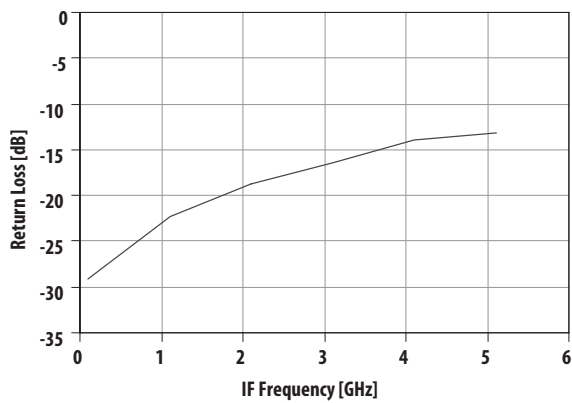

Figure 11. Typical IF port Return Loss vs. IF frequency, $F_{rf}=35\text{GHz}$, and $P_{lo}=+10\text{dBm}$

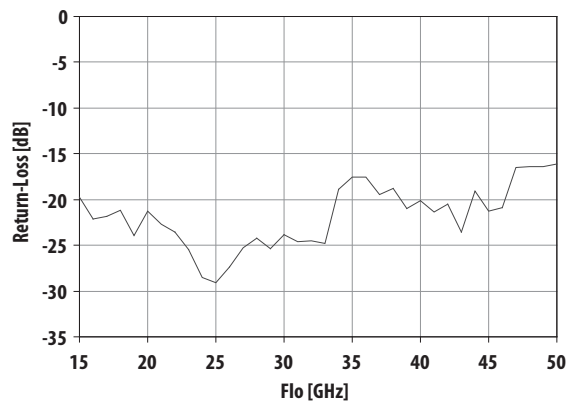

Figure 12. Typical LO port return Loss vs. Frequency, $P_{lo}=+10\text{dBm}$, $F_{if}=1\text{GHz}$

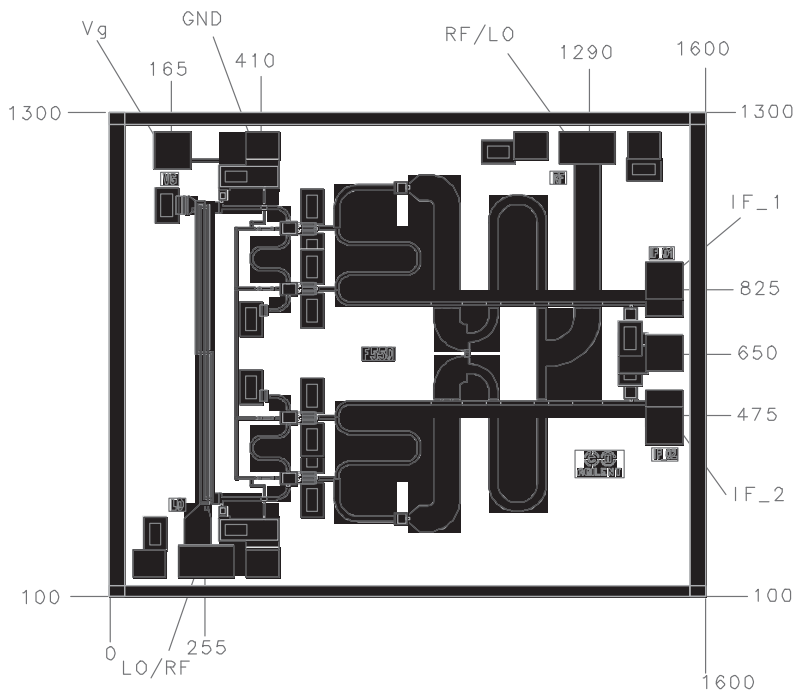

Figure 13. Bond pad location (um)

Assembly Techniques

The backside of the MMIC chip is RF ground. For microstrip applications the chip should be attached directly to the ground plane (e.g. circuit carrier or heatsink) using electrically conductive epoxy [1,2]. For conductive epoxy, the amount should be just enough to provide a thin fillet around the bottom perimeter of the die. The ground plane should be free of any residue that may jeopardize electrical or mechanical attachment. Caution should be taken to not exceed the Absolute Maximum Rating for assembly temperature and time.

Thermo-sonic wedge bonding is the preferred method for wire attachment to the bond pads. The RF connections should be kept as short as possible to minimize inductance. Gold mesh or double-bonding with 0.7mil gold wire is recommended. Mesh can be attached using a 2mil round tracking tool and a too force of approximately 22grams with an ultrasonic power of roughly 55dB for a

duration of $76 \pm 8\text{mS}$. A guided wedge at an ultrasonic power level of 64dB can be used for the 0.7mil wire. The recommended wire bonding stage temperature is $150 \pm 2^\circ\text{C}$.

The chip is 100 μm thick and should be handled with care.

This MMIC has exposed air bridges on the top surface. Handle at the edges or with a custom collet (do not pick up die with vacuum on die center).

This MMIC is also static sensitive and ESD handling precautions should be taken.

Notes:

1. Ablebond 84-1 LM1 silver epoxy is recommended.
2. Eutectic attach is not recommended and may jeopardize reliability of the device.

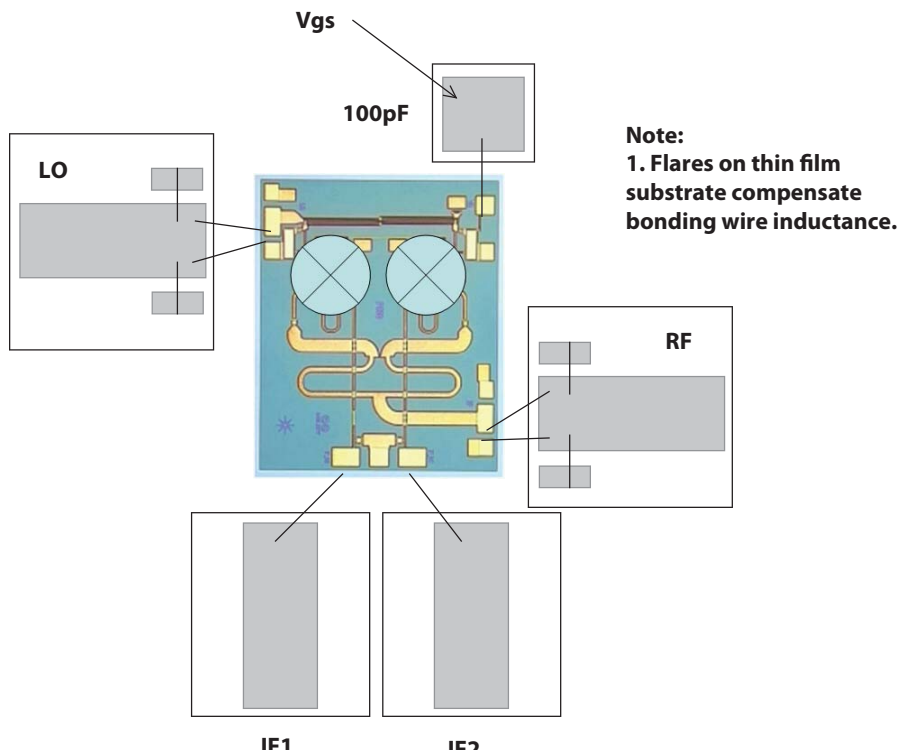

Figure 14. Recommended die assembly

Ordering Information:

AMMC-6550-W10 = 10 devices per tray

AMMC-6550-W50 = 50 devices per tray

For product information and a complete list of distributors, please go to our web site: www.avagotech.com

Avago, Avago Technologies, and the A logo are trademarks of Avago Technologies in the United States and other countries.
Data subject to change. Copyright © 2005-2011 Avago Technologies. All rights reserved. Obsoletes AV01-0394EN
AV02-1285EN - September 23, 2011

