

AMGP-6342

40.5 – 43.5 GHz SMT Packaged Variable Gain Amplifier



Data Sheet



Description

The AMGP-6342 is a broadband variable gain amplifier in a surface mount package designed for use in various applications such as 42 GHz Point-to-Point Radio that operate at frequencies between 40.5 GHz and 43.5 GHz. Over the frequency range it provides 25 dB of gain control with 9 dB small-signal gain and input and output 50 Ω match. OIP3 of +25 is delivered at 43 GHz.

Functional Block Diagram

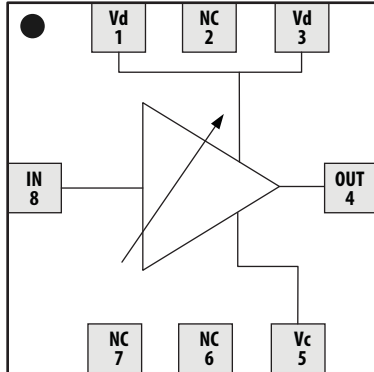

Pin	Function
1	Vd
2	NC
3	Vd
4	RF_OUT
5	Vc
6	NC
7	NC
8	RF_IN

Features

- 5 x 5 mm surface mount package
- RF frequency range from 40.5 to 43.5 GHz
- 9 dB Maximum Gain
- 25 dB Dynamic Range
- +25 dBm Output IP3 @ 43 GHz
- Vd = 5 V and Id = 205 mA
- -1 to 0 V Control voltage (Vc)

Applications

- Microwave Radio Systems
- Test Instrument

Package Diagram

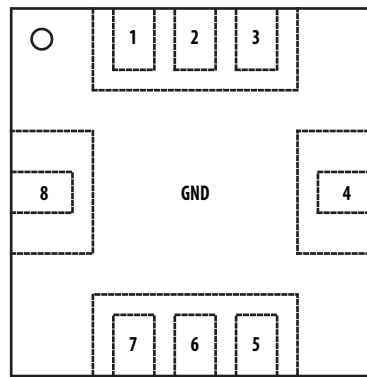

TOP VIEW



Attention: Observe Precautions for handling electrostatic sensitive devices.
ESD Machine Model: 40V
ESD Human Body Model: 150V
Refer to Avago Application Note A004R: Electrostatic Discharge Damage and Control.

ELECTRICAL SPECIFICATIONS

Table 1. Absolute Minimum and Maximum Ratings

Parameter		Specifications			Comments
Description		Min.	Max.	Unit	
Drain Voltage	Vd		5.25	V	
Control Voltage	Vc	-3	+1.5	V	
CW Input Power			5	dBm	
MSL			MSL2A		
Channel Temperature			150	°C	
Storage Temperature		-45	150	°C	

Table 2. Recommended Operating Range

Parameter		Specifications				Comments
Description	Pin	Min.	Typical	Max.	Unit	
Drain Voltage	Vd	4.5	5.0	5.0	V	
Control Voltage	Vc	-1.0		0	V	Vc = -1 V is max. gain state
Frequency range		40.5		43.5	GHz	
Thermal Resistance, θ_{ch-b}			23.9		°C/W	
Case Temperature		-40		+85	°C	
ESD	Human Body Model		150		V	Class 0 is ESD voltage level < 250 V
	Machine Model		40		V	Class A is ESD voltage level < 200 V

Table 3. RF Electrical Characteristics

All data measured on a Rogers 4350 demo board at Vd = 5 V, TA = 25° C and 50 Ω at all ports, unless otherwise specified.

Parameter		Performance			Unit	Comments
		Min.	Typical	Max.		
Gain	40.5GHz	8	11.3		dB	Vc = -1 V
	42GHz		9			
	43.5GHz		9.3			
Gain Dynamic Range	40.5 – 43.5 GHz		25		dB	
Input IP3 (max. Gain)	40.5GHz	8	13		dBm	Pin = -5 dBm / Tone
	42GHz		14.4			
	43.5GHz		13.3			
Noise Figure (max. Gain)			10		dB	@ 40.5 GHz
Input Return Loss	40.5 – 43.5 GHz		10		dB	Over dynamic range
Output Return Loss	40.5 – 43.5 GHz		10		dB	Over dynamic range
Drain Current (Id)			205		mA	
Control Voltage			-1/0		V	-1 V = Max. Gain 0 V = Min. Gain
Control Current (Ic)				1	mA	

**Product Consistency Distribution Charts at 40.5 GHz, 42 GHz and 43.5 GHz, $V_d = 5\text{ V}$, $V_c = -1\text{ V}$.
(Sample size of 2,000 pieces)**

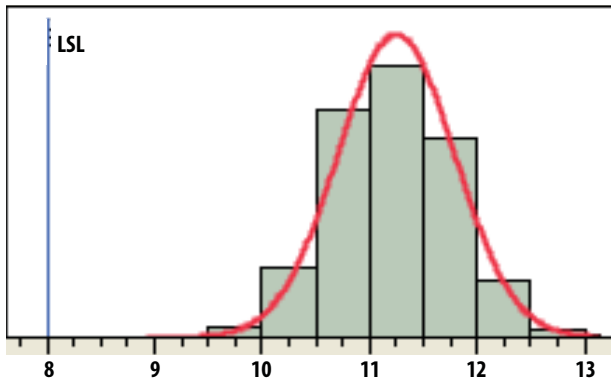

Gain @ 40.5 GHz, Mean = 11.28 dB, LSL = 8 dB

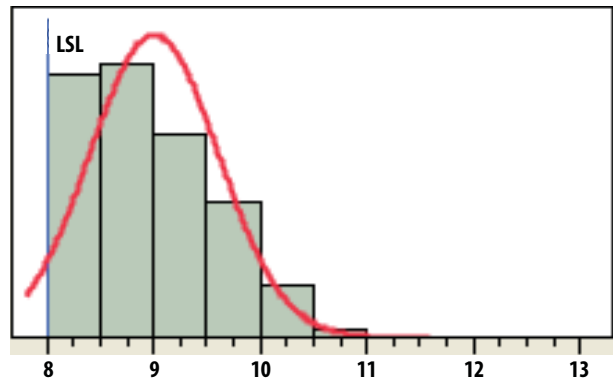

Gain @ 42 GHz, Mean = 8.97 dB, LSL = 8 dB

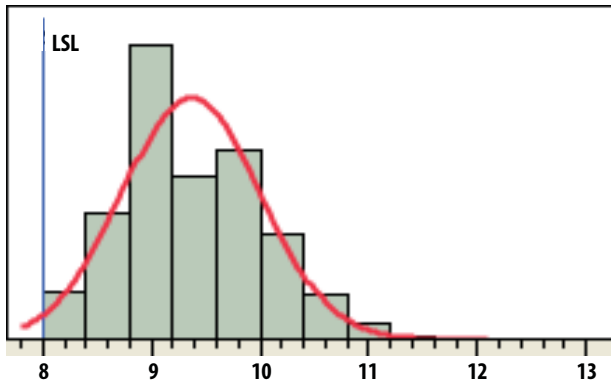

Gain @ 43.5 GHz, Mean = 9.33 dB, LSL = 8 dB

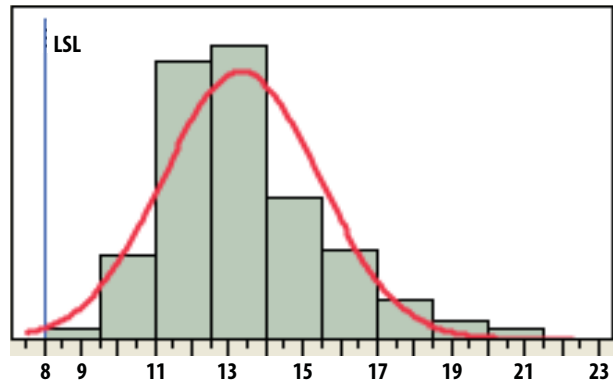

IIP3 @ 40.5 GHz, Mean = 12.92 dBm, LSL = 8 dBm

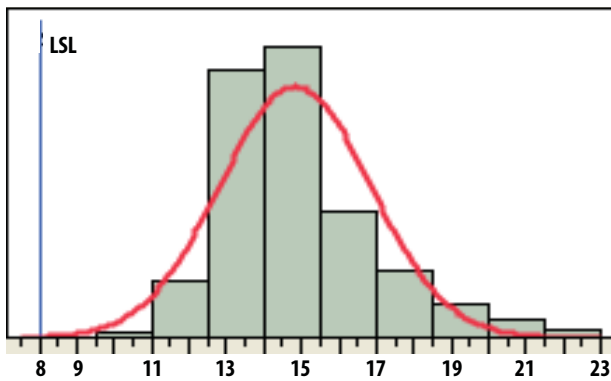

IIP3 @ 42 GHz, Mean = 14.42 dBm, LSL = 8 dBm

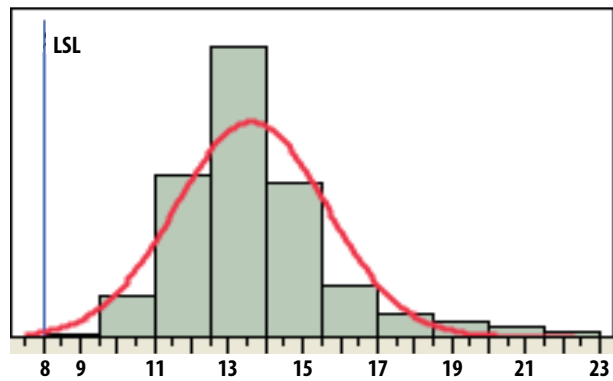

IIP3 @ 43.5 GHz, Mean = 13.33 dBm, LSL = 8 dBm

Selected performance plots

All data measured on connectorized Rogers 4350 demo board at $V_d = 5\text{ V}$, $T_A = 25^\circ\text{ C}$ and $50\ \Omega$ at all ports, unless otherwise specified.

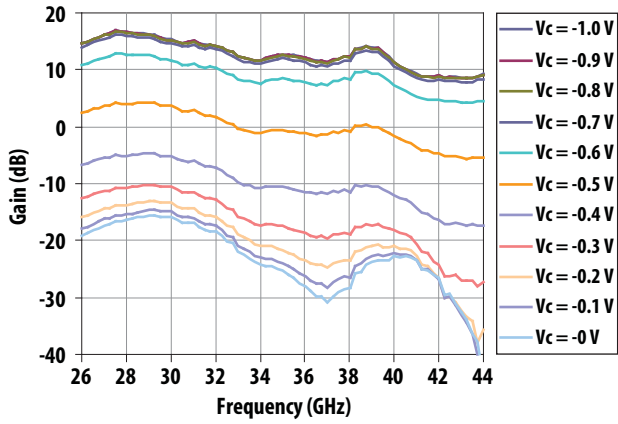

Figure 1. Broadband Gain over Gain Control Voltage V_c

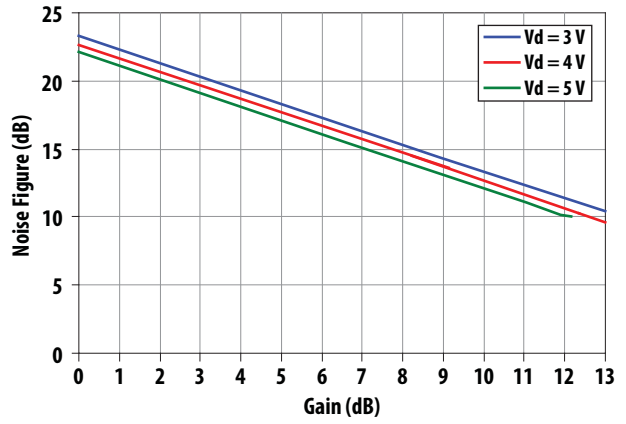

Figure 2. Noise Figure vs Gain @ 40 GHz over $V_d = 3, 4$ and 5 V

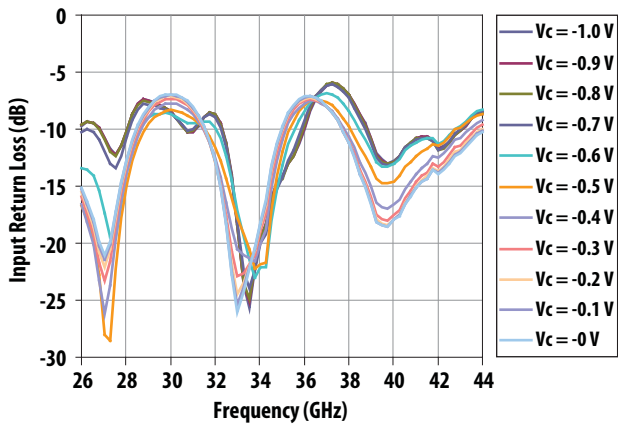

Figure 3. Broadband Input Return Loss over Gain Control Voltage V_c

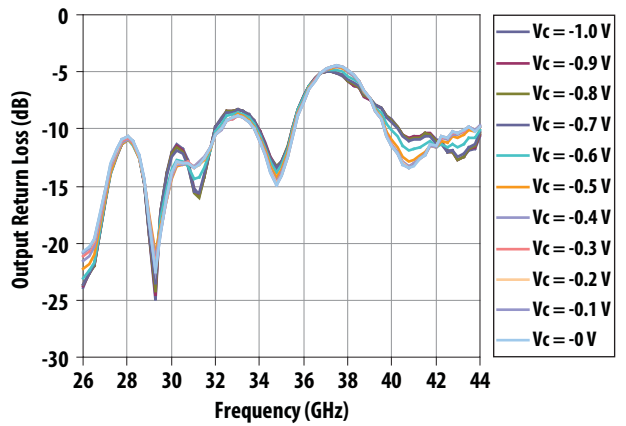

Figure 4. Broadband Output Return Loss over Gain Control Voltage V_c

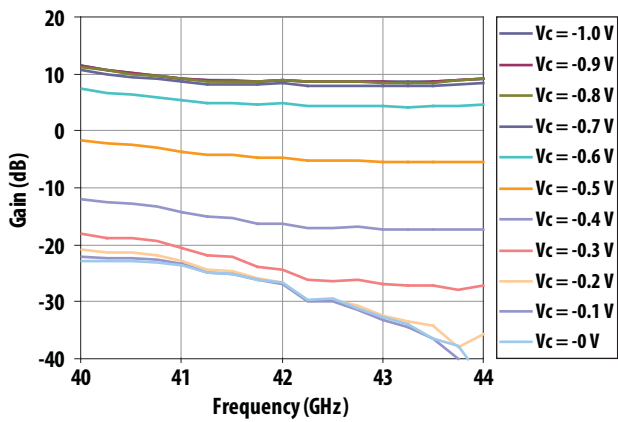

Figure 5. Gain in 40-43.5 GHz Band over Gain Control Voltage V_c

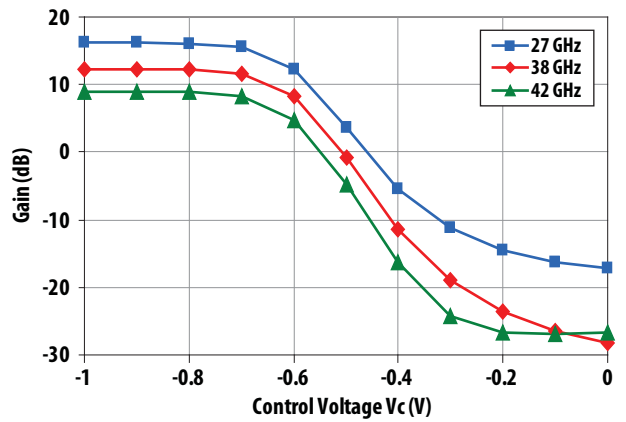

Figure 6. Gain vs Control Voltage V_c @ 27, 38 and 42 GHz

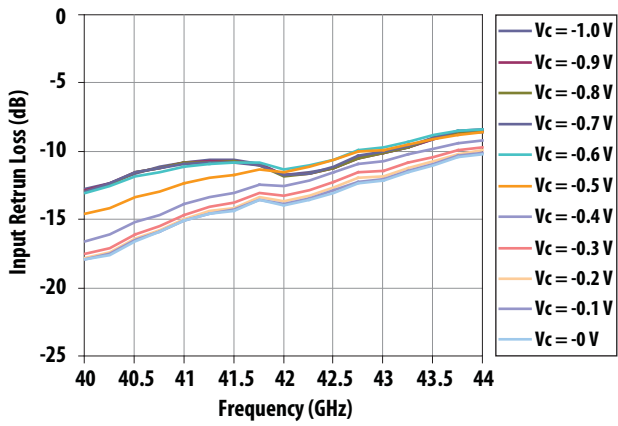

Figure 7. Input Return Loss in 40-43.5 GHz Band over Gain Control Voltage V_c

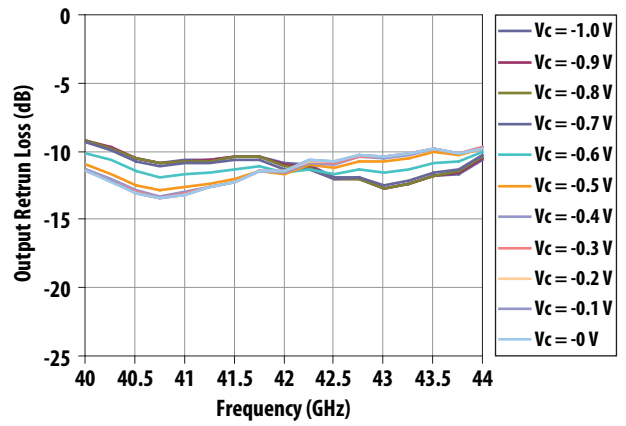

Figure 8. Output Return Loss in 40-43.5 GHz Band over Gain Control Voltage V_c

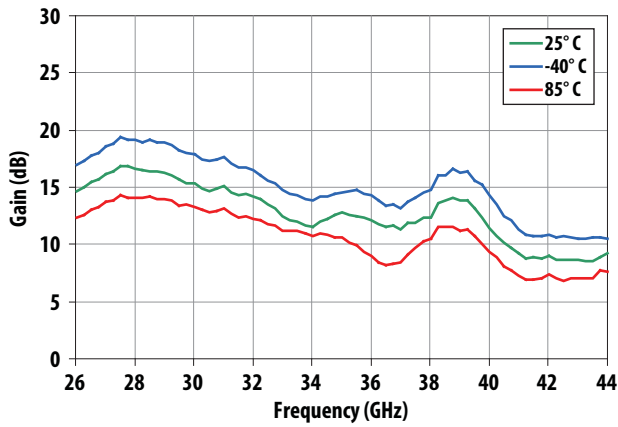

Figure 9. Broadband Gain Over Temperature

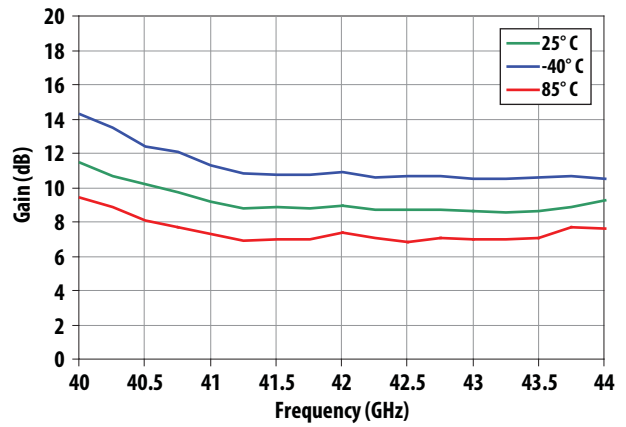

Figure 10. Gain in 40-43.5 GHz Band Over Temperature

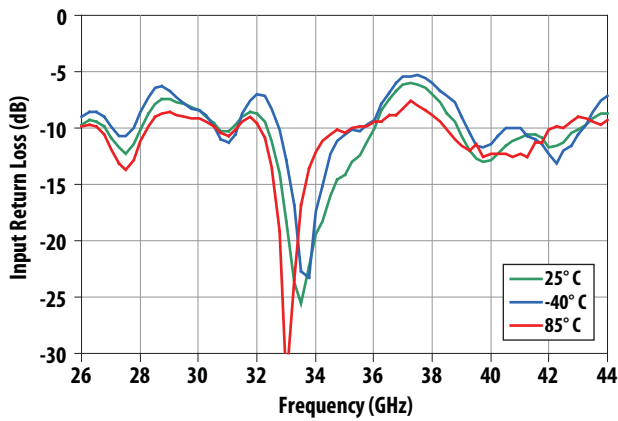

Figure 11. Broadband Input Return Loss Over Temperature

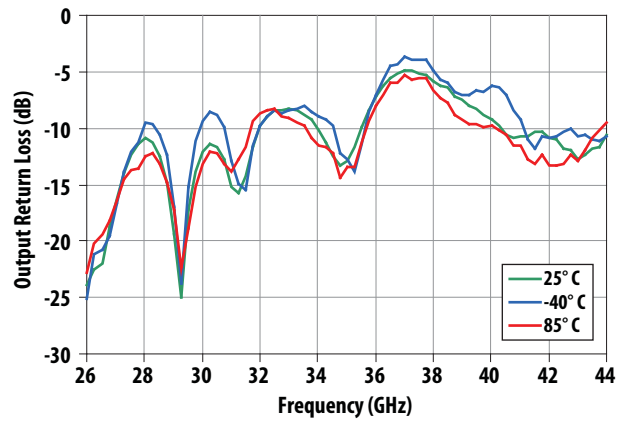

Figure 12. Broadband Output Return Loss Over Temperature

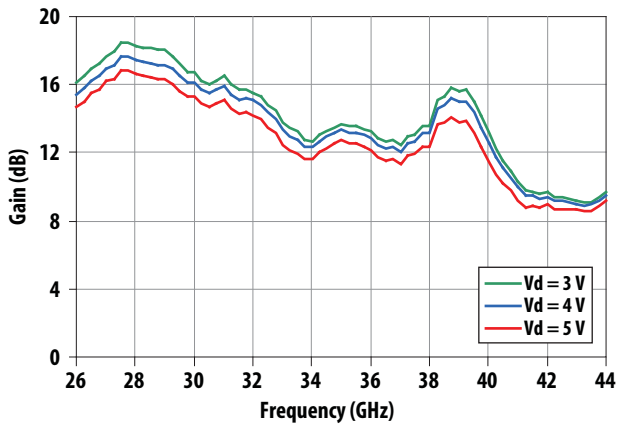

Figure 13. Broadband Gain Over Drain Bias Vd

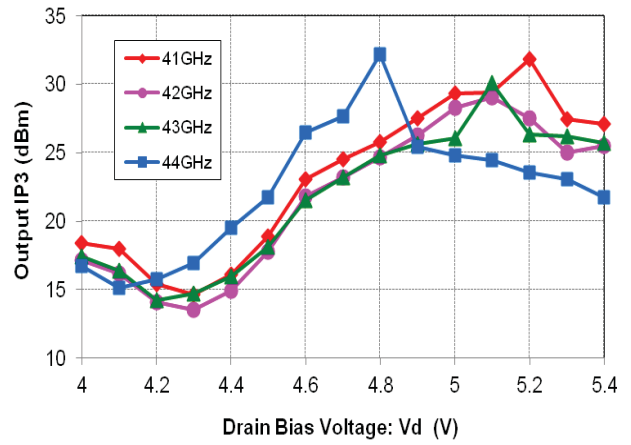

Figure 14. Output IP3 vs. Drain Bias Vd

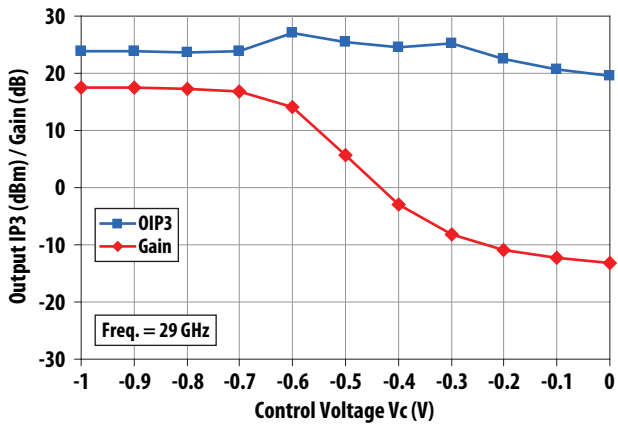

Figure 15. Output IP3 and Gain vs. Control Voltage @ 29 GHz

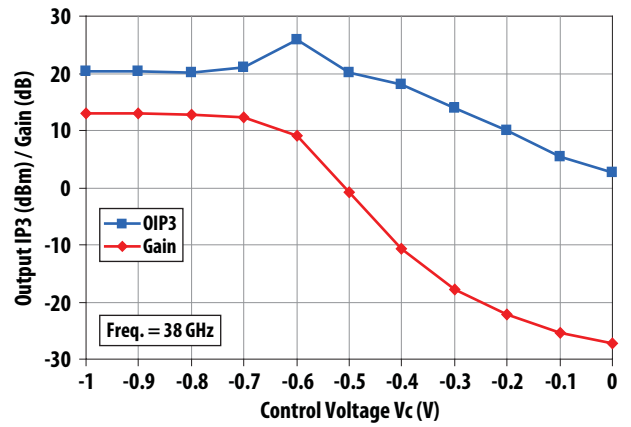

Figure 16. Output IP3 and Gain vs. Control Voltage @ 38 GHz

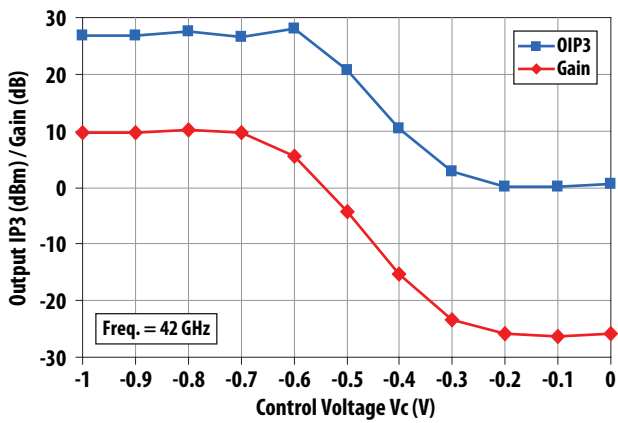

Figure 17. Output IP3 and Gain vs Control Voltage @ 42 GHz

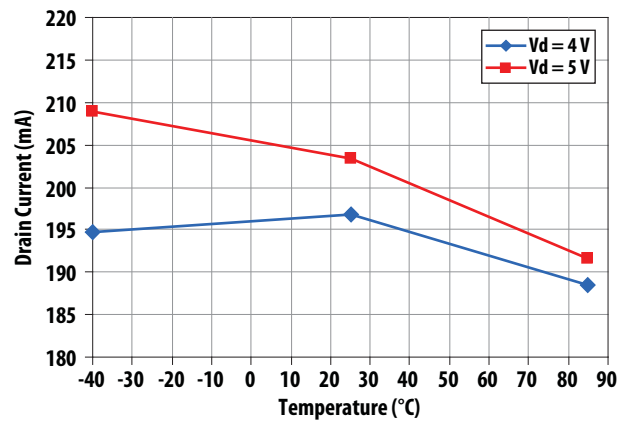

Figure 18. Drain Bias Current vs Temperature over Vd

Evaluation Board Description

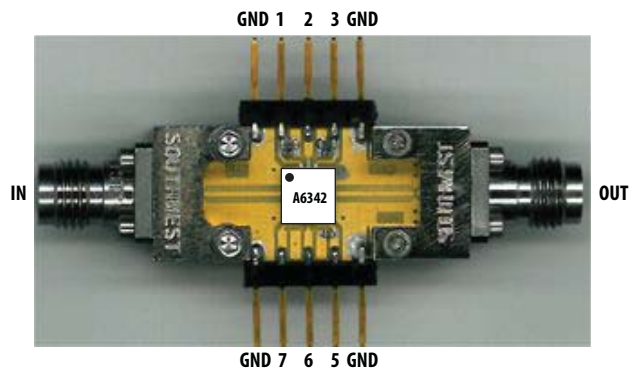

Table 4. Pin Description

Pin #	Function	Biasing	Comment
GND	GND		
1	Vd	5.0 V	Pins 2 & 4 are internally connected
2	NC		
3	Vd (opt)	5.0 V (opt)	Pins 2 & 4 are internally connected
GND	GND		
GND	GND		
5	Vc	-1 to 0 V	< 1 mA
6	NC		
7	NC		
GND	GND		

Package Dimension, PCB Layout and Tape and Reel information

Please refer to Avago Technologies Application Note 5521, AMxP-xxxx production Assembly Process (Land Pattern B).

Demo board circuit for AMGP-6342

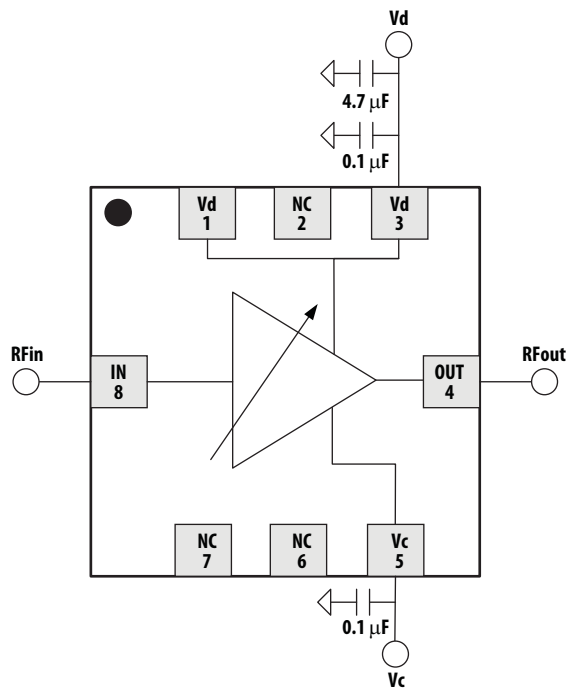

Note: Pins 1 and 3 are internally connected. Only either pin 2 or pin 4 should be used for Vd, not both.

Part Number Ordering Information

Part Number	Devices per Container	Container
AMGP-6342-BLKG	10	antistatic bag
AMGP-6342-TR1G	100	7" Reel
AMGP-6342-TR2G	500	7" Reel

For product information and a complete list of distributors, please go to our web site: www.avagotech.com

Avago, Avago Technologies, and the A logo are trademarks of Avago Technologies in the United States and other countries. Data subject to change. Copyright © 2005-2012 Avago Technologies. All rights reserved. AV02-3209EN - May 10, 2012

AVAGO
TECHNOLOGIES