

AFCT-57R5ATPZ

SFP, 1310 nm, 10 km, LC Connector,
Pluggable Fibre Channel 4.25/2.125/1.0625 GBd

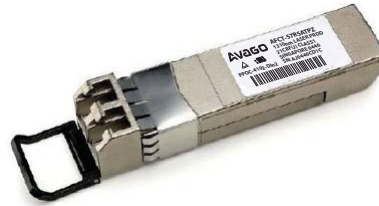

Data Sheet



Description

The AFCT-57R5ATPZ optical transceiver supports high-speed serial links over singlemode optical fiber at signaling rates up to 4.25 Gb/s. Compliant with Small Form Pluggable (SFP) Multi Source Agreement (MSA) mechanical and electrical specifications, ANSI Fibre Channel FC-PI-3 and compatible with IEEE 802.3 for gigabit applications.

As an enhancement to the conventional SFP interface defined in SFF-8074i, the AFCT-57R5ATPZ is compliant to SFF-8472 (digital diagnostic interface for SFP). Using the 2-wire serial interface defined in the SFP MSA, the AFCT-57R5ATPZ provides real time temperature, supply voltage, laser bias current, laser average output power and received average input power. This information is in addition to the conventional SFP data. The digital diagnostic interface also adds the ability to disable the transmitter (TX_DISABLE), monitor for Transmitter Faults (TX_FAULT), monitor for Receiver Loss of Signal (RX_LOS).

Applications

- Fibre channel systems
 - Director class switches
 - Fabric switches
 - HBA cards
- Disk and tape drive arrays

Related Products

- AFBR-59R5LZ: 850 nm +3.3 V LC SFF 2x7 for 4.25/2.125/1.0625 GBd Fibre Channel
- AFBR-57R5APZ: 850 nm +3.3 V LC SFP for 4.25/2.125/1.0625 GBd Fibre Channel
- AFCT-57R5APZ: 1310 nm +3.3 V LC SFP for 4.25/2.125/1.0625 GBd Fibre Channel Over 4 km

Features

- Diagnostic features per SFF-8472 "Diagnostic Monitoring Interface for Optical Transceivers"
- Compliant to Restriction on Hazardous Substances (RoHS) directive
- Real time monitors of:
 - Transmitted average optical power
 - Received average optical power
 - Laser bias current
 - Temperature
 - Supply voltage
- High performance 1310 nm DFB laser
- Wide Temperature and Supply Voltage Operation (-10°C to 85°C) (3.3 V \pm 10%)
- Transceiver specifications per SFP (SFF-8074i) Multi-Source Agreement and SFF-8472 (revision 9.3)
 - 4.25 GBd Fibre Channel operation for FC-PI-2 400-SM-LC-L
 - 2.125 GBd Fibre Channel operation for FC-PI-2 200-SM-LC-L
 - 1.0625 GBd Fibre Channel operation for FC-PI-2 100-SM-LC-L
- Link lengths at 4.25 GBd: 10 km with 9 μ m SMF
- Link lengths at 2.125 GBd: 10 km with 9 μ m SMF
- Link lengths at 1.0625 GBd: 10 km with 9 μ m SMF
- LC Duplex optical connector interface conforming to ANSI TIA/EIA604-10 (FOCIS 10)
- IEC 60825-1 Class 1/CDRH Class 1 laser eye safe

Installation

The AFCT-57R5ATPZ can be installed in any SFF-8074i compliant Small Form Pluggable (SFP) port regardless of host equipment operating status. The AFCT-57R5ATPZ is hot-pluggable, allowing the module to be installed while the host system is operating and on-line. Upon insertion, the transceiver housing makes initial contact with the host board SFP cage, mitigating potential damage due to Electro-Static Discharge (ESD).

Digital Diagnostic Interface and Serial Identification

The 2-wire serial interface is based on ATMEL AT24C01A series EEPROM protocol and signaling detail. Conventional SFP EEPROM memory, bytes 0-255 at memory address 0xA0, is organized in compliance with SFF-8074i. New digital diagnostic information, bytes 0-255 at memory address 0xA2, is compliant to SFF-8472. The new diagnostic information provides the opportunity for Predictive Failure Identification, Compliance Prediction, Fault Isolation and Component Monitoring.

The I2C accessible memory page address 0xB0 is used internally by SFP for the test and diagnostic purposes and it is reserved.

Predictive Failure Identification

The AFCT-57R5ATPZ predictive failure feature allows a host to identify potential link problems before system performance is impacted. Prior identification of link problems enables a host to service an application via “fail over” to a redundant link or replace a suspect device, maintaining system uptime in the process. For applications where ultra-high system uptime is required, a digital SFP provides a means to monitor two real-time laser metrics associated with observing laser degradation and predicting failure: average laser bias current (Tx_Bias) and average laser optical power (Tx_Power).

Compliance Prediction

Compliance prediction is the ability to determine if an optical transceiver is operating within its operating and environmental requirements. AFCT-57R5ATPZ devices provide real-time access to transceiver internal supply voltage and temperature, allowing a host to identify potential component compliance issues. Received optical power is also available to assess compliance of a cable plant and remote transmitter. When operating out of requirements, the link cannot guarantee error free transmission.

Fault Isolation

The fault isolation feature allows a host to quickly pinpoint the location of a link failure, minimizing downtime. For optical links, the ability to identify a fault at a local device, remote device or cable plant is crucial to speeding service of an installation. AFCT-57R5ATPZ real-time monitors of Tx_Bias, Tx_Power, Vcc, Temperature and Rx_Power can be used to assess local transceiver current operating conditions. In addition, status flags Tx_Disable and Rx Loss of Signal (LOS) are mirrored in memory and available via the two-wire serial interface.

Component Monitoring

Component evaluation is a more casual use of the AFCT-57R5ATPZ real-time monitors of Tx_Bias, Tx_Power, Vcc, Temperature and Rx_Power. Potential uses are as debugging aids for system installation and design, and transceiver parametric evaluation for factory or field qualification. For example, temperature per module can be observed in high density applications to facilitate thermal evaluation of blades, PCI cards and systems.

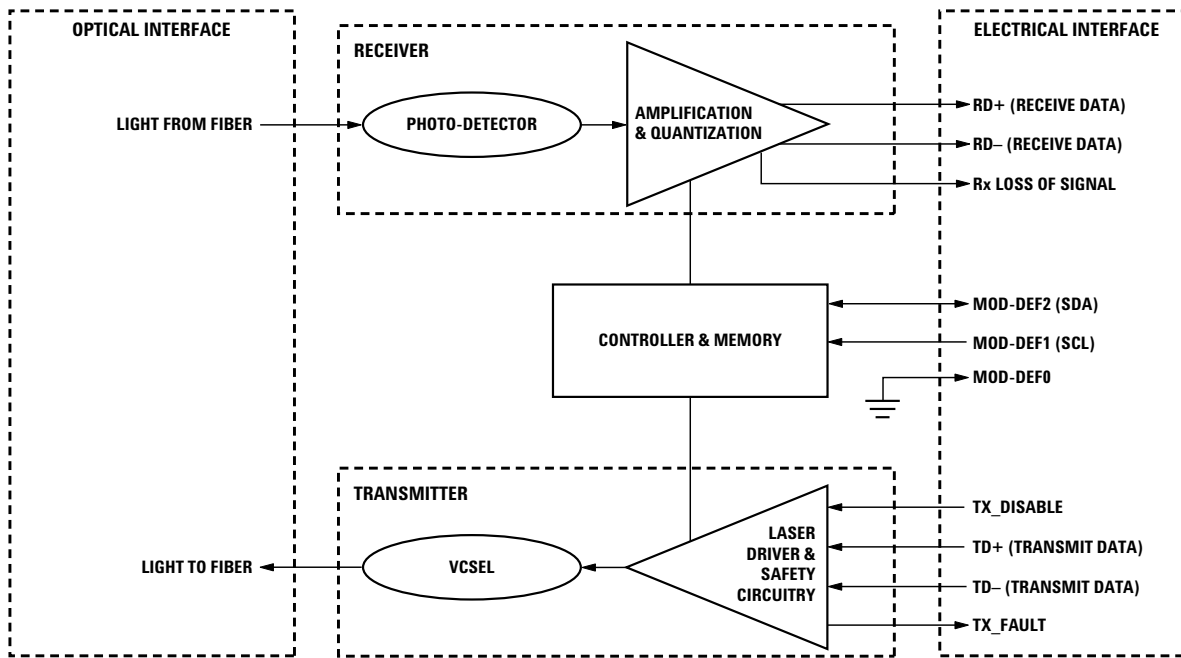

Figure 1. Transceiver functional diagram.

Transmitter Section

The transmitter section includes a 1310-nm distributed feedback (DFB) laser and a transmitter driver circuit. The driver circuit maintains a constant average optical power output with Fibre Channel and Ethernet 8B/10B coded data. Optical connection to the transmitter is provided via an LC connector. The TOSA is driven by a custom IC which uses the incoming differential high speed logic signal to modulate the laser diode driver current. This Tx laser driver circuit regulates the optical power at a constant level provided the incoming data pattern is dc balanced (8B/10B code, for example).

Transmit Disable (TX_DISABLE)

The AFCT-57R5ATPZ accepts a TTL and CMOS compatible transmit disable control signal input (pin 3) which shuts down the transmitter optical output. A high signal implements this function while a low signal allows normal transceiver operation. In the event of a fault (e.g. eye safety circuit activated), cycling this control signal resets the module as depicted in Figure 4. An internal pull up resistor disables the transceiver transmitter until the host pulls the input low. Host systems should allow a 10 ms interval between successive assertions of this control signal. Tx_Disable can also be asserted via the two-wire serial interface (address A2h, byte 110, bit 6) and monitored (address A2h, byte 110, bit 7).

The contents of A2h, byte 110, bit 6 are logic OR'd with hardware Tx_Disable (pin 3) to control transmitter operation

Transmit Fault (TX_FAULT)

A catastrophic laser fault will activate the transmitter signal, TX_FAULT, and disable the laser. This signal is an open collector output (pull-up required on the host board). A low signal indicates normal laser operation and a high signal indicates a fault. The TX_FAULT will be latched high when a laser fault occurs and is cleared by toggling the TX_DISABLE input or power cycling the transceiver. The transmitter fault condition can also be monitored via the two-wire serial interface (address A2, byte 110, bit 2).

Eye Safety Circuit

The AFCT-57R5ATPZ provides Class 1 (single fault tolerant) eye safety by design and has been tested for compliance with the requirements listed in Table 1. The eye safety circuit continuously monitors the optical output power level and will disable the transmitter upon detecting an unsafe condition beyond the scope of Class 1 certification. Such unsafe conditions can be due to inputs from the host board (Vcc fluctuation, unbalanced code) or a fault within the transceiver.

Receiver Section

The receiver section includes the Receiver Optical Sub-Assembly (ROSA) and the amplification/quantization circuitry. The ROSA, containing a PIN photodiode and custom transimpedance amplifier, is located at the optical interface and mates with the LC optical connector. The ROSA output is fed to a custom IC that provides post-amplification and quantization.

Receiver Loss of Signal (Rx_LOS)

The post-amplification IC also includes transition detection circuitry which monitors the ac level of incoming optical signals and provides a TTL/CMOS compatible status signal to the host (pin 8). An adequate optical input results in a low Rx_LOS output while a high Rx_LOS output indicates an unusable optical input. The Rx_LOS thresholds are factory set so that a high output indicates a definite optical fault has occurred. Rx_LOS can also be monitored via the two-wire serial interface (address A2h, byte 110, bit 1).

Functional Data I/O

The AFCT-57R5ATPZ interfaces with the host circuit board through twenty I/O pins (SFP electrical connector) identified by function in Table 2. The board layout for this interface is depicted in Figure 6.

The AFCT-57R5ATPZ high speed transmit and receive interfaces require SFP MSA compliant signal lines on the host board. To simplify board requirements, biasing resistors and ac coupling capacitors are incorporated into the SFP transceiver module (per SFF-8074i) and hence are not required on the host board. The Tx_Disable, Tx_Fault, Rx_LOS require TTL lines on the host board (per SFF-8074i) if used. If an application chooses not to take advantage of the functionality of these pins, care must be taken to ground Tx_Disable (for normal operation).

Figure 2 depicts the recommended interface circuit to link the AFCT-57R5ATPZ to supporting physical layer ICs. Timing for MSA compliant control signals implemented in the transceiver are listed in Figure 4.

Application Support

An Evaluation Kit and Reference Designs are available to assist in evaluation of the AFCT-57R5ATPZ. Please contact your local Field Sales representative for availability and ordering details.

Caution

There are no user serviceable parts nor maintenance requirements for the AFCT-57R5ATPZ. All mechanical adjustments are made at the factory prior to shipment. Tampering with, modifying, misusing or improperly handling the AFCT-57R5ATPZ will void the product warranty. It may also result in improper operation and possibly overstress the laser source. Performance degradation or device failure may result. Connection of the AFCT-57R5ATPZ to a light source not compliant with ANSI FC-PI or IEEE 802.3 specifications, operating above maximum operating conditions or in a manner inconsistent with its design and function may result in exposure to hazardous light radiation and may constitute an act of modifying or manufacturing a laser product. Persons performing such an act are required by law to re-certify and re-identify the laser product under the provisions of U.S. 21 CFR (Subchapter J) and TUV.

Ordering Information

Please contact your local field sales engineer or one of Avago Technologies franchised distributors for ordering information. For technical information, please visit Avago Technologies' WEB page at www.avagotech.com or contact Avago Technologies Semiconductor Products Customer Response Center at 1-800-235-0312. For information related to SFF Committee documentation visit www.sffcommittee.org.

Regulatory Compliance

The AFCT-57R5ATPZ complies with all applicable laws and regulations as detailed in Table 1. Certification level is dependent on the overall configuration of the host equipment. The transceiver performance is offered as a figure of merit to assist the designer.

Electrostatic Discharge (ESD)

The AFCT-57R5ATPZ is compatible with ESD levels found in typical manufacturing and operating environments as described in Table 1. In the normal handling and operation of optical transceivers, ESD is of concern in two circumstances.

The first case is during handling of the transceiver prior to insertion into an SFP compliant cage. To protect the device, it's important to use normal ESD handling precautions. These include using of grounded wrist straps, work-benches and floor wherever a transceiver is handled.

The second case to consider is static discharges to the exterior of the host equipment chassis after installation. If the optical interface is exposed to the exterior of host equipment cabinet, the transceiver may be subject to system level ESD requirements.

Electromagnetic Interference (EMI)

Equipment incorporating gigabit transceivers is typically subject to regulation by the FCC in the United States, CENELEC EN55022 (CISPR 22) in Europe and VCCI in Japan. The AFCT-57R5ATPZ's compliance to these standards is detailed in Table 1. The metal housing and shielded design of the AFCT-57R5ATPZ minimizes the EMI challenge facing the equipment designer.

EMI Immunity (Susceptibility)

Due to its shielded design, the EMI immunity of the AFCT-57R5ATPZ exceeds typical industry standards.

Flammability

The AFCT-57R5ATPZ optical transceiver is made of metal and high strength, heat resistant, chemical resistant and UL 94V-0 flame retardant plastic.

Table 1. Regulatory Compliance

Feature	Test Method	Performance
Electrostatic Discharge (ESD) to the Electrical Pins	MIL-STD-883C Method 3015.4	Class 2 (> 2000 Volts)
Electrostatic Discharge (ESD) to the Duplex LC Receptacle	Variation of IEC 61000-4-2 GR1089	Typically, no damage occurs with 25 kV when the duplex LC connector receptacle is contacted by a Human Body Model probe. 10 contacts of 8 kV on the electrical faceplate with device inserted into a panel.
Electrostatic Discharge (ESD) to the Optical Connector	Variation of IEC 801-2	Air discharge of 15 kV (min.) contact to connector without damage.
Electromagnetic Interference (EMI)	FCC Class B CENELEC EN55022 Class B (CISPR 22A) VCCI Class 1	System margins are dependent on customer board and chassis design.
Immunity	Variation of IEC 61000-4-3	Typically shows no measurable effect from a 10 V/m swept from 10 MHz to 1 GHz.
Laser Eye Safety and Equipment Type Testing 	US FDA CDRH AEL Class 1 US21 CFR, Subchapter J per Paragraphs 1002.10 and 1002.12 (IEC) EN60825-1: 1994 + A11 + A2 (IEC) EN60825-2: 1994 + A1 (IEC) EN60950: 1992 + A1 + A2 + A3 + A4 + A11	CDRH #9521220-141 TUV #933/21205741/010
Component Recognition	Underwriters Laboratories and Canadian Standards Association Joint Component Recognition for Information Technology Equipment including Electrical Business Equipment	UL #E173874
Restriction on Hazardous Substances (RoHS) Compliance		Less than 1000 ppm of cadmium, lead, mercury, hexavalent chromium, polybrominated biphenyls, and polybrominated biphenyl ethers.

Table 2. Pin Description

Pin	Name	Function/Description	Notes
1	VeeT	Transmitter Ground	
2	TX_FAULT	Transmitter Fault Indication – High indicates a fault condition	Note 1
3	TX_DISABLE	Transmitter Disable – Module optical output disables on high or open	Note 2
4	MOD-DEF2	Module Definition 2 – Two wire serial ID interface data line (SDA)	Note 3
5	MOD-DEF1	Module Definition 1 – Two wire serial ID interface clock line (SCL)	Note 3
6	MOD-DEF0	Module Definition 0 – Grounded in module (module present indicator)	Note 3
7	N.C.		
8	RX_LOS	Loss of Signal – High indicates loss of received optical signal	Note 4
9	VeeR	Receiver Ground	
10	VeeR	Receiver Ground	
11	VeeR	Receiver Ground	
12	RD-	Inverse Received Data Out	Note 5
13	RD+	Received Data Out	Note 5
14	VeeR	Receiver Ground	
15	VccR	Receiver Power + 3.3 V	Note 6
16	VccT	Transmitter Power + 3.3 V	Note 6
17	VeeT	Transmitter Ground	
18	TD+	Transmitter Data In	Note 7
19	TD-	Inverse Transmitter Data In	Note 7
20	VeeT	Transmitter Ground	

Notes:

- TX_FAULT is an open collector/drain output, which must be pulled up with a 4.7 k – 10 kΩ resistor on the host board. When high, this output indicates a laser fault of some kind. Low indicates normal operation. In the low state, the output will be pulled to < 0.8V.
- TX_DISABLE is an input that is used to shut down the transmitter optical output. It is internally pulled up (within the transceiver) with a 6.8 kΩ resistor.
Low (0 – 0.8V): Transmitter on
Between (0.8V and 2.0V): Undefined
High (2.0 – Vcc max) or OPEN: Transmitter Disabled
- The signals Mod-Def 0, 1, 2 designate the two wire serial interface pins. They must be pulled up with a 4.7 k – 10 kΩ resistor on the host board.
Mod-Def 0 is grounded by the module to indicate the module is present
Mod-Def 1 is serial clock line (SCL) of two wire serial interface
Mod-Def 2 is serial data line (SDA) of two wire serial interface
- RX_LOS (Rx Loss of Signal) is an open collector/drain output that must be pulled up with a 4.7 k – 10 kΩ resistor on the host board. When high, this output indicates the received optical power is below the worst case receiver sensitivity (as defined by the standard in use). Low indicates normal operation. In the low state, the output will be pulled to < 0.8V.
- RD-/+ designate the differential receiver outputs. They are AC coupled 100Ω differential lines which should be terminated with 100Ω differential at the host SERDES input. AC coupling is done inside the transceiver and is not required on the host board. The voltage swing on these lines will be between 600 and 1600 mV differential (300 – 800 mV single ended) when properly terminated.
- VccR and VccT are the receiver and transmitter power supplies. They are defined at the SFP connector pin. The maximum supply current is 300 mA and the associated in-rush current will typically be no more than 30 mA above steady state after 2 microseconds.
- TD-/+ designate the differential transmitter inputs. They are AC coupled differential lines with 100 Ω differential termination inside the module. The AC coupling is done inside the module and is not required on the host board. The inputs will accept differential swings of 400 – 2400 mV (200 – 1200 mV single ended), although it is recommended that values between 500 mV and 1200 mV differential (250-600 mV single ended) be used for best EMI.

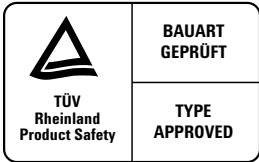
Table 3. Absolute Maximum Ratings

Parameter	Symbol	Minimum	Maximum	Unit	Notes
Storage Temperature	T_S	-40	100	C	Note 1, 2
Case Operating Temperature	T_C	-10	85	C	Note 1, 2
Relative Humidity	RH	5	85	%	Note 1
Supply Voltage	$V_{CC,T,R}$	-0.5	3.8	V	Note 1, 2, 3
Low Speed Input Voltage	V_{IN}	-0.5	$V_{CC} + 0.5$	V	Note 1

Notes;

1. Absolute Maximum Ratings are those values beyond which damage to the device may occur if these limits are exceeded for other than a short period of time. See Reliability Data Sheet for specific reliability performance.
2. Between Absolute Maximum Ratings and the Recommended Operating Conditions functional performance is not intended, device reliability is not implied, and damage to the device may occur over an extended period of time.
3. The module supply voltages, $V_{CC,T}$ and $V_{CC,R}$ must not differ by more than 0.5 V or damage to the device may occur.

Table 4. Recommended Operating Conditions

Parameter	Symbol	Minimum	Maximum	Unit	Notes
Supply Voltage	$V_{CC,T,R}$	2.97	3.63	V	Note 2
Data Rate		1.0625	4.25	Gb/s	Note 2
T_{case}		-10	85	°C	Note 1, 2

Notes:

1. The Ambient Operating Temperature limitations are based on the Case Operating Temperature limitations and are subject to the host system thermal design.
2. Recommended Operating Conditions are those values for which functional performance and device reliability is implied.

Table 5. Transceiver Electrical Characteristics

($T_C = -10^\circ\text{C}$ to 85°C , $V_{CC,T}$, $V_{CC,R} = 3.3\text{V} \pm 10\%$)

Parameter	Symbol	Minimum	Typical	Maximum	Unit	Notes
AC Electrical Characteristics						
Power Supply Noise Rejection (peak-peak)	PSNR		100		mV	Note 1
DC Electrical Characteristics						
Module Supply Current	I_{CC}		215	300 mA @ 70°C 350 mA @ 85°C		
Power Dissipation	P_{DISS}			1000	mW	
Low Speed Outputs: Transmit Fault (TX_FAULT), Loss of Signal (RX_LOS), MOD-DEF 2	V_{OH} V_{OL}	2.0		$V_{CC,T,R} + 0.3$ 0.8	V V	Note 2
Low Speed Inputs: Transmit Disable (TX_DIS), MOD-DEF 1, MOD-DEF 2	V_{IH} V_{IL}	2.0 0		V_{CC} 0.8	V V	Note 3

Notes:

1. Filter per SFP specification is required on host board to remove 10 Hz to 2 MHz content.
2. Pulled up externally with a 4.7 k – 10 k Ω resistor on the host board to 3.3 V.
3. Pulled up externally with a 4.7 k – 10 k Ω resistor on the host board to 3.3 V.

Table 6. Transmitter and Receiver Electrical Characteristics
($T_c = -10^\circ\text{C}$ to 85°C , $V_{ccT}, V_{ccR} = 3.3\text{ V} \pm 10\%$)

Parameter	Symbol	Minimum	Typical	Maximum	Unit	Notes
High Speed Data Input: Transmitter Differential Input Voltage (TD +/-)	V_I	400		2400	mV	Note 1
High Speed Data Output: Receiver Differential Output Voltage (RD +/-)	V_o	600		1600	mV	Note 2
Receiver Contributed Total Jitter (4.25 Gb/s)	TJ			0.26 61	UI ps	Note 3
Receiver Contributed Total Jitter (2.125 Gb/s)	TJ			0.26 122	UI ps	Note 3
Receiver Contributed Total Jitter (1.0625 Gb/s)	TJ			0.20 188	UI ps	Note 3
Receiver Electrical Output Rise & Fall Times (20-80%)	t_r, t_f	50	100	150	ps	Note 4

Notes:

1. Internally AC coupled and terminated (100 Ohm differential).
2. Internally AC coupled but requires an external load termination (100 Ohm differential).
3. Contributed DJ is measured on an oscilloscope in average mode with 50% threshold and K28.5 pattern. Contributed TJ is the sum of contributed RJ and contributed J. Contributed RJ is calculated for 1×10^{-12} BER by multiplying the RMS jitter (measured on a single rise or fall edge) from the oscilloscope by 14. Per FC-PI-2 (Table 9 - SM jitter output, note 1), the actual contributed RJ is allowed to increase above its limit if the actual contributed DJ decreases below its limits, as long as the component output DJ and TJ remain within their specified FC-PI-2 maximum limits with the worst case specified component jitter input.
4. 20%-80% electrical rise & fall times measured with a 500 MHz signal utilizing a 1010 data pattern.

Table 7. Transmitter Optical Characteristics

($T_c = -10^{\circ}\text{C}$ to 85°C , $V_{ccT}, V_{ccR} = 3.3\text{ V} \pm 10\%$)

Parameter	Symbol	Minimum	Typical	Maximum	Unit	Notes
Modulated Optical Output Power (OMA) (Peak-to-Peak) 4.25 Gb/s	T_x, OMA	290	350		μW	Note 6
Modulated Optical Output Power (OMA) (Peak-to-Peak) 2.125 Gb/s	T_x, OMA	290	350		μW	Note 3
Modulated Optical Output Power (OMA) (Peak-to-Peak) 1.0625 Gb/s	T_x, OMA	290	350		μW	Note 4
Average Optical Output Power	P_{out}	-8.4		-3.0	dBm	Note 1, 2
Center Wavelength	λ_c	1290		1340	nm	Note 3, 4, 6
Spectral Width – rms	σ, rms				nm	Note 3, 4, 6
Optical Rise/Fall Time (4.25 Gb/s)	t_r, t_f			90	ps	20% - 80%
RIN_{12} (OMA)	RIN			-118	dB/Hz	
Transmitter Contributed Total Jitter (4.25 Gb/s)	TJ			0.25	UI	Note 5
				60	ps	
Transmitter Contributed Total Jitter (2.125 Gb/s)	TJ			0.25	UI	Note 5
				120	ps	
Transmitter Contributed Total Jitter (1.0625 Gb/s)	TJ			0.27	UI	Note 5
				252	ps	
P_{out} TX_DISABLE Asserted	P_{OFF}			-35	dBm	

Notes:

1. Max P_{out} is the lesser of Class 1 safety limits (CDRH and EN 60825) or receiver power, max.
2. Into 9/125 μm single-mode optical fiber.
3. OMA, center wavelength and spectral width must comply with FC-PI clause 6.3.5, Figure 19 (200-SM-LC-L triple trade-off curve).
4. OMA, center wavelength and spectral width must comply with FC-PI clause 6.3.5, Figure 18 (100-SM-LC-L triple trade-off curve).
5. Contributed DJ is measured on an oscilloscope in average mode with 50% threshold and K28.5 pattern. Contributed TJ is the sum of contributed RJ and contributed DJ. Contributed RJ is calculated for 1×10^{-12} BER by multiplying the RMS jitter (measured on a single rise or fall edge) from the oscilloscope by 14. Per FC-PI (Table 9 - SM jitter output, note 1), the actual contributed RJ is allowed to increase above its limit if the actual contributed DJ decreases below its limits, as long as the component output DJ and TJ remain within their specified FC-PI maximum limits with the worst case specified component jitter input.
6. OMA, center wavelength and spectral width must comply with FC-PI-2 clause 6.3.5, Figure 20 (400-SM-LC-L triple trade-off curve).

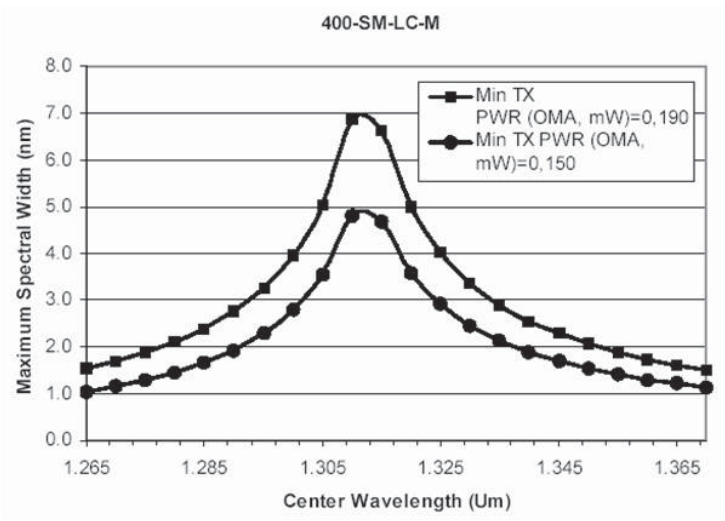

Table 8. Receiver Optical Characteristics**($T_C = -10^\circ\text{C}$ to 85°C , $V_{CC1}, V_{CC2} = 3.3\text{ V} \pm 10\%$)**

Parameter	Symbol	Min.	Typ.	Max.	Unit	Notes
Input Optical Power [Overdrive]	P_{IN}			-3	dBm, avg	
Input Optical Modulation Amplitude (Peak-to-Peak) 4.25 Gb/s [Sensitivity]	OMA	29			μW , oma	Notes 2, 4
Input Optical Modulation Amplitude (Peak-to-Peak) 2.125 Gb/s [Sensitivity]	OMA	15			μW , oma	Notes 1, 4
Input Optical Modulation Amplitude (Peak-to-Peak) 1.0625 Gb/s [Sensitivity]	OMA	15			μW , oma	Notes 1, 4
Return Loss		12			dB	
Loss of Signal – Assert	P_A			13.8	μW , oma	
			-30	-20.5	dBm, avg	Note 3
Loss of Signal – De-Assert	P_D			15	μW , oma	
				-20.0	dBm, avg	Note 3
Loss of Signal Hysteresis	$P_D - P_A$	0.5			dB	

Notes:

1. For illustrative purposes, consider the an example where an OMA of 15 μW is approximately equal to an average power of -20 dBm, avg. with an Extinction Ratio of 9 dB.
2. For illustrative purposes, consider the an example where an OMA of 29 μW is approximately equal to an average power of -17.3 dBm, avg. with an Extinction Ratio of 9 dB.
3. These average power values are specified with an Extinction Ratio of 9 dB. The loss of signal circuitry responds to valid 8B/10B encoded peak to peak input optical power, not average power.
4. Input Optical Modulation Amplitude (commonly known as sensitivity) requires a valid 8B/10B encoded input.

Table 9. Transceiver Timing Characteristics
($T_C = -10^{\circ}\text{C}$ to 85°C , $V_{CC1}, V_{CCR} = 3.3\text{V} \pm 10\%$)

Parameter	Symbol	Minimum	Maximum	Unit	Notes
Hardware TX_DISABLE Assert Time	t_off		10	μs	Note 1
Hardware TX_DISABLE Negate Time	t_on		1	ms	Note 2
Time to initialize, including reset of TX_FAULT	t_init		300	ms	Note 3
Hardware TX_FAULT Assert Time	t_fault		100	μs	Note 4
Hardware TX_DISABLE to Reset	t_reset	10		μs	Note 5
Hardware RX_LOS DeAssert Time	t_loss_on		100	μs	Note 6
Hardware RX_LOS Assert Time	t_loss_off		100	μs	Note 7
Software TX_DISABLE Assert Time	t_off_soft		100	ms	Note 8
Software TX_DISABLE Negate Time	t_on_soft		100	ms	Note 9
Software Tx_FAULT Assert Time	t_fault_soft		100	ms	Note 10
Software Rx_LOS Assert Time	t_loss_on_soft		100	ms	Note 11
Software Rx_LOS De-Assert Time	t_loss_off_soft		100	ms	Note 12
Analog parameter data ready	t_data		1000	ms	Note 13
Serial bus hardware ready	t_serial		300	ms	Note 14
Write Cycle Time	t_write		10	ms	Note 15
Serial ID Clock Rate	f_serial_clock		400	kHz	

Notes:

1. Time from rising edge of TX_DISABLE to when the optical output falls below 10% of nominal.
2. Time from falling edge of TX_DISABLE to when the modulated optical output rises above 90% of nominal.
3. Time from power on or falling edge of Tx_Disable to when the modulated optical output rises above 90% of nominal.
4. From power on or negation of TX_FAULT using TX_DISABLE.
5. Time TX_DISABLE must be held high to reset the laser fault shutdown circuitry.
6. Time from loss of optical signal to Rx_LOS Assertion.
7. Time from valid optical signal to Rx_LOS De-Assertion.
8. Time from two-wire interface assertion of TX_DISABLE (A2h, byte 110, bit 6) to when the optical output falls below 10% of nominal. Measured from falling clock edge after stop bit of write transaction.
9. Time from two-wire interface de-assertion of TX_DISABLE (A2h, byte 110, bit 6) to when the modulated optical output rises above 90% of nominal.
10. Time from fault to two-wire interface TX_FAULT (A2h, byte 110, bit 2) asserted.
11. Time for two-wire interface assertion of Rx_LOS (A2h, byte 110, bit 1) from loss of optical signal.
12. Time for two-wire interface de-assertion of Rx_LOS (A2h, byte 110, bit 1) from presence of valid optical signal.
13. From power on to data ready bit asserted (A2h, byte 110, bit 0). Data ready indicates analog monitoring circuitry is functional.
14. Time from power on until module is ready for data transmission over the serial bus (reads or writes over A0h and A2h).
15. Time from stop bit to completion of a 1-8 byte write command.

Table 10. Transceiver Digital Diagnostic Monitor (Real Time Sense) Characteristics**($T_C = -15^\circ\text{C}$ to 85°C , $V_{ccT}, V_{ccR} = 3.3\text{ V} \pm 10\%$)**

Parameter	Symbol	Min.	Units	Notes
Transceiver Internal Temperature Accuracy	T_{INT}	± 3.0	$^\circ\text{C}$	Temperature is measured internal to the transceiver. Valid from -10°C to 85°C case temperature.
Transceiver Internal Supply Voltage Accuracy	V_{INT}	± 0.1	V	Supply voltage is measured internal to the transceiver and can, with less accuracy, be correlated to voltage at the SFP Vcc pin. Valid over $3.3\text{ V} \pm 10\%$.
Transmitter Laser DC Bias Current Accuracy	I_{INT}	± 10	%	I_{INT} is better than $\pm 10\%$ of the nominal value.
Transmitted Average Optical Output Power Accuracy	P_T	± 3.0	dB	Coupled into $9/125\ \mu\text{m}$ single-mode fiber. Valid from $100\ \mu\text{W}$ to $500\ \mu\text{W}$, average.
Received Optical Input Power Accuracy	P_R	± 3.0	dB	Coupled from $9/125\ \mu\text{m}$ single-mode fiber. Valid from $15\ \mu\text{W}$ to $500\ \mu\text{W}$, average.

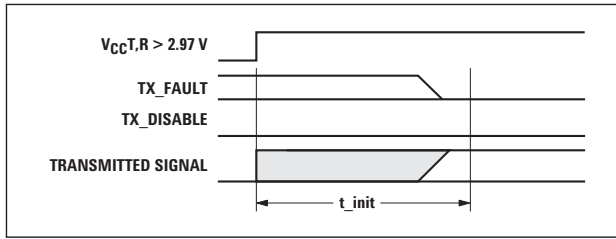

t-init: TX DISABLE NEGATED

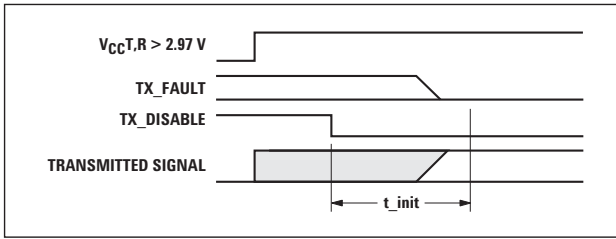

t-init: TX DISABLE ASSERTED

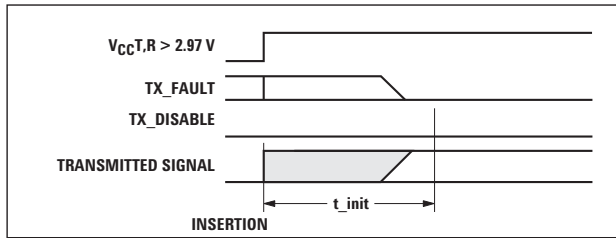

t-init: TX DISABLE NEGATED, MODULE HOT PLUGGED

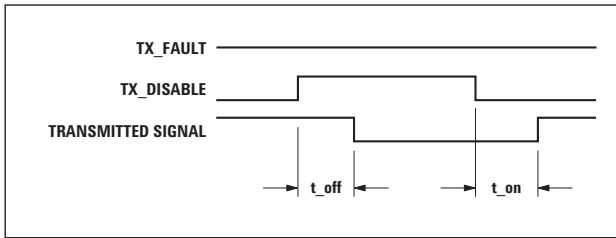

t-off & t-on: TX DISABLE ASSERTED THEN NEGATED

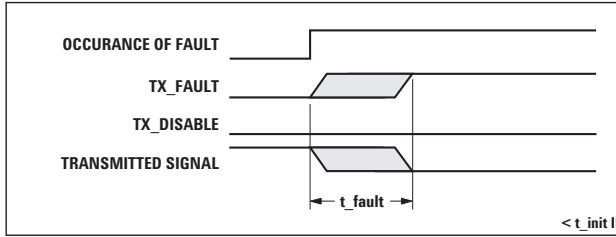

t-fault: TX FAULT ASSERTED, TX SIGNAL NOT RECOVERED

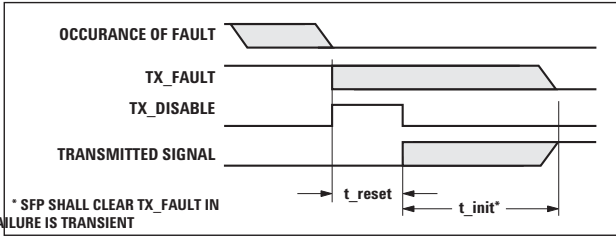

t-reset: TX DISABLE ASSERTED THEN NEGATED, TX SIGNAL RECOVERED

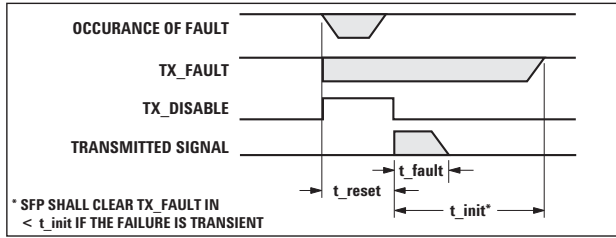

t-fault: TX DISABLE ASSERTED THEN NEGATED, TX SIGNAL NOT RECOVERED

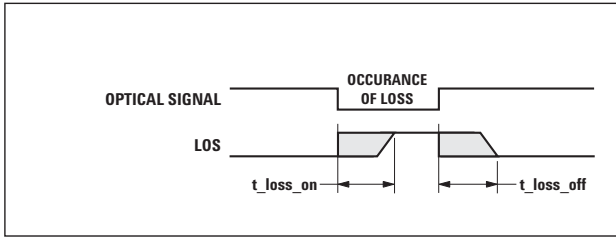

t-loss-on & t-loss-off

Figure 4. Transceiver timing diagrams (module installed except where noted).

Table 12. EEPROM Serial ID Memory Contents – Conventional SFP Memory (Address A0h)

Byte # Decimal	Data Hex	Notes	Byte # Decimal	Data Hex	Notes
0	03	SFP physical device	37	00	Hex Byte of Vendor OUI ^[2]
1	04	SFP function defined by serial ID only	38	17	Hex Byte of Vendor OUI ^[2]
2	07	LC optical connector	39	6A	Hex Byte of Vendor OUI ^[2]
3	00		40	41	"A" - Vendor Part Number ASCII character
4	00		41	46	"F" - Vendor Part Number ASCII character
5	00		42	43	"C" - Vendor Part Number ASCII character
6	00		43	54	"T" - Vendor Part Number ASCII character
7	12	Long distance (per FC-PI), Longwave Laser (LC)	44	2D	"-" - Vendor Part Number ASCII character
8	00		45	35	"5" - Vendor Part Number ASCII character
9	01	Single Mode (SM)	46	37	"7" - Vendor Part Number ASCII character
10	15	100, 200 & 400 Mbytes/sec FC-PI speed ^[1]	47	52	"R" - Vendor Part Number ASCII character
11	01	Compatible with 8B/10B encoded data	48	35	"5" - Vendor Part Number ASCII character
12	2B	4300 MBit/sec nominal bit rate (4.25 Gbit/s)	41	41	"A" - Vendor Part Number ASCII character
13	00		54	54	"T" - Vendor Part Number ASCII character
14	0A	10 km of 9 µm/125 µm single mode fiber	50	50	"P" - Vendor Part Number ASCII character
15	64	10 km of 9 µm/125 µm single mode fiber	5A	5A	"Z" - Vendor Part Number ASCII character
16	00		53	20	" " - Vendor Part Number ASCII character
17	00		54	20	" " - Vendor Part Number ASCII character
18	00		55	20	" " - Vendor Part Number ASCII character
19	00		56	20	" " - Vendor Part Number ASCII character
20	41	"A" - Vendor Name ASCII character	57	20	" " - Vendor Part Number ASCII character
21	56	"V" - Vendor Name ASCII character	58	20	" " - Vendor Part Number ASCII character
22	41	"A" - Vendor Name ASCII character	59	20	" " - Vendor Part Number ASCII character
23	47	"G" - Vendor Name ASCII character	60	05	Hex Byte of Laser Wavelength ^[3]
24	4F	"O" - Vendor Name ASCII character	61	1E	Hex Byte of Laser Wavelength ^[3]
25	20	" " - Vendor Name ASCII character	62	00	
26	20	" " - Vendor Name ASCII character	63		Checksum for Bytes 0-62 ^[4]
27	20	" " - Vendor Name ASCII character	64	00	
28	20	" " - Vendor Name ASCII character	65	1A	Hardware SFP TX_DISABLE, TX_FAULT, & RX_LOS
29	20	" " - Vendor Name ASCII character	66	00	
30	20	" " - Vendor Name ASCII character	67	00	
31	20	" " - Vendor Name ASCII character	68-83		Vendor Serial Number ASCII characters ^[5]
32	20	" " - Vendor Name ASCII character	84-91		Vendor Date Code ASCII characters ^[6]
33	20	" " - Vendor Name ASCII character	92	68	Digital Diagnostics, Internal Cal, Rx Pwr Avg
34	20	" " - Vendor Name ASCII character	93	F0	A/W, Soft SFP TX_DISABLE, TX_FAULT, & RX_LOS
35	20	" " - Vendor Name ASCII character	94	01	SFF-8472 Compliance to revision 9.3
36	00		95		Checksum for Bytes 64-94 ^[4]
			96 - 255	00	

Notes:

1. FC-PI speed 100 MBytes/sec is a serial bit rate of 1.0625 GBit/sec. 200 MBytes/sec is a serial bit rate of 2.125 GBit/sec. 400 MBytes/sec is a serial bit rate of 4.25 GBit/sec.
2. The IEEE Organizationally Unique Identifier (OUI) assigned to Avago Technologies is 00-17-6A (3 bytes of hex).
3. Laser wavelength is represented in 16 unsigned bits. The hex representation of 1310 (nm) is 051E.
4. Addresses 63 and 95 are checksums calculated (per SFF-8472 and SFF-8074) and stored prior to product shipment.
5. Addresses 68-83 specify the AFCT-57R5ATPZ ASCII serial number and will vary on a per unit basis.
6. Addresses 84-91 specify the AFCT-57R5ATPZ ASCII date code and will vary on a per date code basis.

Table 13: EEPROM Serial ID Memory Contents – Enhanced Feature Set Memory (Address A2h)

Byte # Decimal	Notes	Byte # Decimal	Notes	Byte # Decimal	Notes
0	Temp H Alarm MSB ^[1]	26	Tx Pwr L Alarm MSB ^[4]	104	Real Time Rx average MSB ^[5]
1	Temp H Alarm LSB ^[1]	27	Tx Pwr L Alarm LSB ^[4]	105	Real Time Rx average LSB ^[5]
2	Temp L Alarm MSB ^[1]	28	Tx Pwr H Warning MSB ^[4]	106	Reserved
3	Temp L Alarm LSB ^[1]	29	Tx Pwr H Warning LSB ^[4]	107	Reserved
4	Temp H Warning MSB ^[1]	30	Tx Pwr L Warning MSB ^[4]	108	Reserved
5	Temp H Warning LSB ^[1]	31	Tx Pwr L Warning LSB ^[4]	109	Reserved
6	Temp L Warning MSB ^[1]	32	Rx Pwr H Alarm MSB ^[5]	110	Status/Control - See Table 14
7	Temp L Warning LSB ^[1]	33	Rx Pwr H Alarm LSB ^[5]	111	Reserved
8	Vcc H Alarm MSB ^[2]	34	Rx Pwr L Alarm MSB ^[5]	112	Flag Bits - See Table 15
9	Vcc H Alarm LSB ^[2]	35	Rx Pwr L Alarm LSB ^[5]	113	Flag Bits - See Table 15
10	Vcc L Alarm MSB ^[2]	36	Rx Pwr H Warning MSB ^[5]	114	Reserved
11	Vcc L Alarm LSB ^[2]	37	Rx Pwr H Warning LSB ^[5]	115	Reserved
12	Vcc H Warning MSB ^[2]	38	Rx Pwr L Warning MSB ^[5]	116	Flag Bits - See Table 15
13	Vcc H Warning LSB ^[2]	39	Rx Pwr L Warning LSB ^[5]	117	Flag Bits - See Table 15
14	Vcc L Warning MSB ^[2]	40-55	Reserved	118-127	Reserved
15	Vcc L Warning LSB ^[2]	56-94	External Calibration Constants ^[6]	128-247	Customer Writeable
16	Tx Bias H Alarm MSB ^[3]	95	Checksum for Bytes 0-94 ^[7]	248-255	Vendor Specific
17	Tx Bias H Alarm LSB ^[3]	96	Real Time Temperature MSB ^[1]		
18	Tx Bias L Alarm MSB ^[3]	97	Real Time Temperature LSB ^[1]		
19	Tx Bias L Alarm LSB ^[3]	98	Real Time Vcc MSB ^[2]		
20	Tx Bias H Warning MSB ^[3]	99	Real Time Vcc LSB ^[2]		
21	Tx Bias H Warning LSB ^[3]	100	Real Time Tx Bias MSB ^[3]		
22	Tx Bias L Warning MSB ^[3]	101	Real Time Tx Bias LSB ^[3]		
23	Tx Bias L Warning LSB ^[3]	102	Real Time Tx Power MSB ^[4]		
24	Tx Pwr H Alarm MSB ^[4]	103	Real Time Tx Power LSB ^[4]		
25	Tx Pwr H Alarm LSB ^[4]				

Notes:

1. Temperature (Temp) is decoded as a 16 bit signed twos complement integer in increments of 1/256°C.
2. Supply Voltage (Vcc) is decoded as a 16 bit unsigned integer in increments of 100 μ V.
3. Laser bias current (Tx Bias) is decoded as a 16 bit unsigned integer in increments of 2 μ A.
4. Transmitted average optical power (Tx Pwr) is decoded as a 16 bit unsigned integer in increments of 0.1 μ W.
5. Received average optical power (Rx Pwr) is decoded as a 16 bit unsigned integer in increments of 0.1 μ W.
6. Bytes 55-94 are not intended for use with AFCT-57R5ATPZ, but have been set to default values per SFF-8472.
7. Byte 95 is a checksum calculated (per SFF-8472) and stored prior to product shipment.

Table 14. EEPROM Serial ID Memory Contents – Soft Commands (Address A2h, Byte 110)

Bit #	Status/ Control Name	Description	Notes
7	TX_DISABLE State	Digital state of SFP TX_DISABLE Input Pin (1 = TX_DISABLE asserted)	Note 1
6	Soft TX_DISABLE	Read/write bit for changing digital state of TX_DISABLE function	Note 1, 2
5	Reserved		
4	Reserved		
3	Reserved		
2	TX_FAULT State	Digital state of the SFP TX_FAULT output pin (1 = TX_FAULT asserted)	Note 1
1	RX_LOS State	Digital state of the SFP RX_LOS output pin (1 = RX_LOS asserted)	Note 1
0	Data Ready (Bar)	Indicates transceiver is powered and real time sense data is ready. (0 = Ready)	Note 1

Notes:

1. The response time for soft commands of the AFCT-57R5ATPZ is 100 msec as specified by the MSA SFF-8472.
2. Bit 6 is logic OR'd with the SFP TX_DISABLE input pin 3 ... either asserted will disable the SFP transmitter.

Table 15. EEPROM Serial ID Memory Contents – Alarms and Warnings (Address A2h, Bytes 112, 113, 116, 117)

Byte	Bit	Flag Bit Name	Description
112	7	Temp High Alarm	Set when transceiver internal temperature exceeds high alarm threshold
	6	Temp Low Alarm	Set when transceiver internal temperature exceeds low alarm threshold
	5	Vcc High Alarm	Set when transceiver internal supply voltage exceeds high alarm threshold
	4	Vcc Low Alarm	Set when transceiver internal supply voltage exceeds low alarm threshold
	3	Tx Bias High Alarm	Set when transceiver laser bias current exceeds high alarm threshold
	2	Tx Bias Low Alarm	Set when transceiver laser bias current exceeds low alarm threshold
	1	Tx Power High Alarm	Set when transmitted average optical power exceeds high alarm threshold
	0	Tx Power Low Alarm	Set when transmitted average optical power exceeds low alarm threshold
113	7	Rx Power High Alarm	Set when received optical power exceeds high alarm threshold
	6	Rx Power Low Alarm	Set when received optical power exceeds low alarm threshold
	0-5	Reserved	
116	7	Temp High Warning	Set when transceiver internal temperature exceeds high warning threshold
	6	Temp Low Warning	Set when transceiver internal temperature exceeds low warning threshold
	5	Vcc High Warning	Set when transceiver internal supply voltage exceeds high warning threshold
	4	Vcc Low Warning	Set when transceiver internal supply voltage exceeds low warning threshold
	3	Tx Bias High Warning	Set when transceiver laser bias current exceeds high warning threshold
	2	Tx Bias Low Warning	Set when transceiver laser bias current exceeds low warning threshold
	1	Tx Power High Warning	Set when transmitted average optical power exceeds high warning threshold
	0	Tx Power Low Warning	Set when transmitted average optical power exceeds low warning threshold
117	7	Rx Power High Warning	Set when received optical power exceeds high warning threshold
	6	Rx Power Low Warning	Set when received optical power exceeds low warning threshold
	0-5	Reserved	

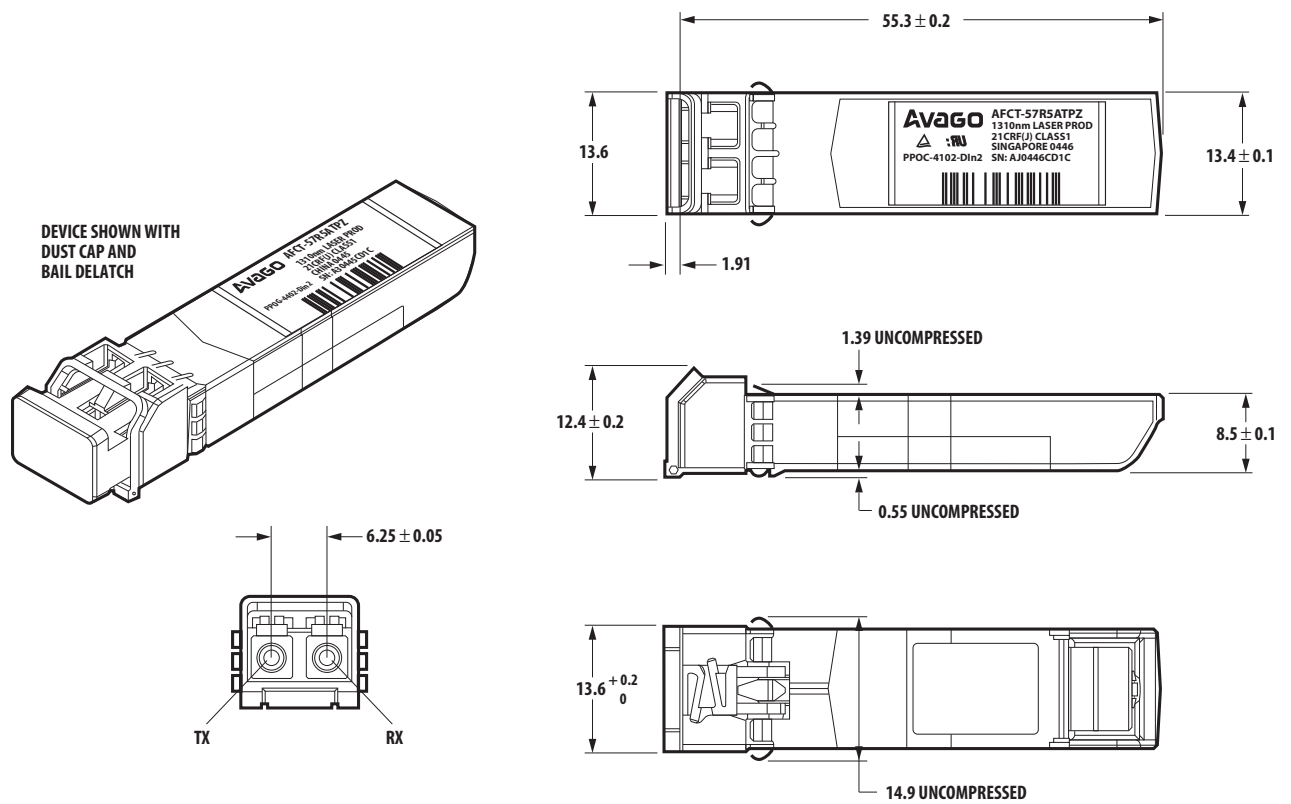

Figure 5. Module drawing.

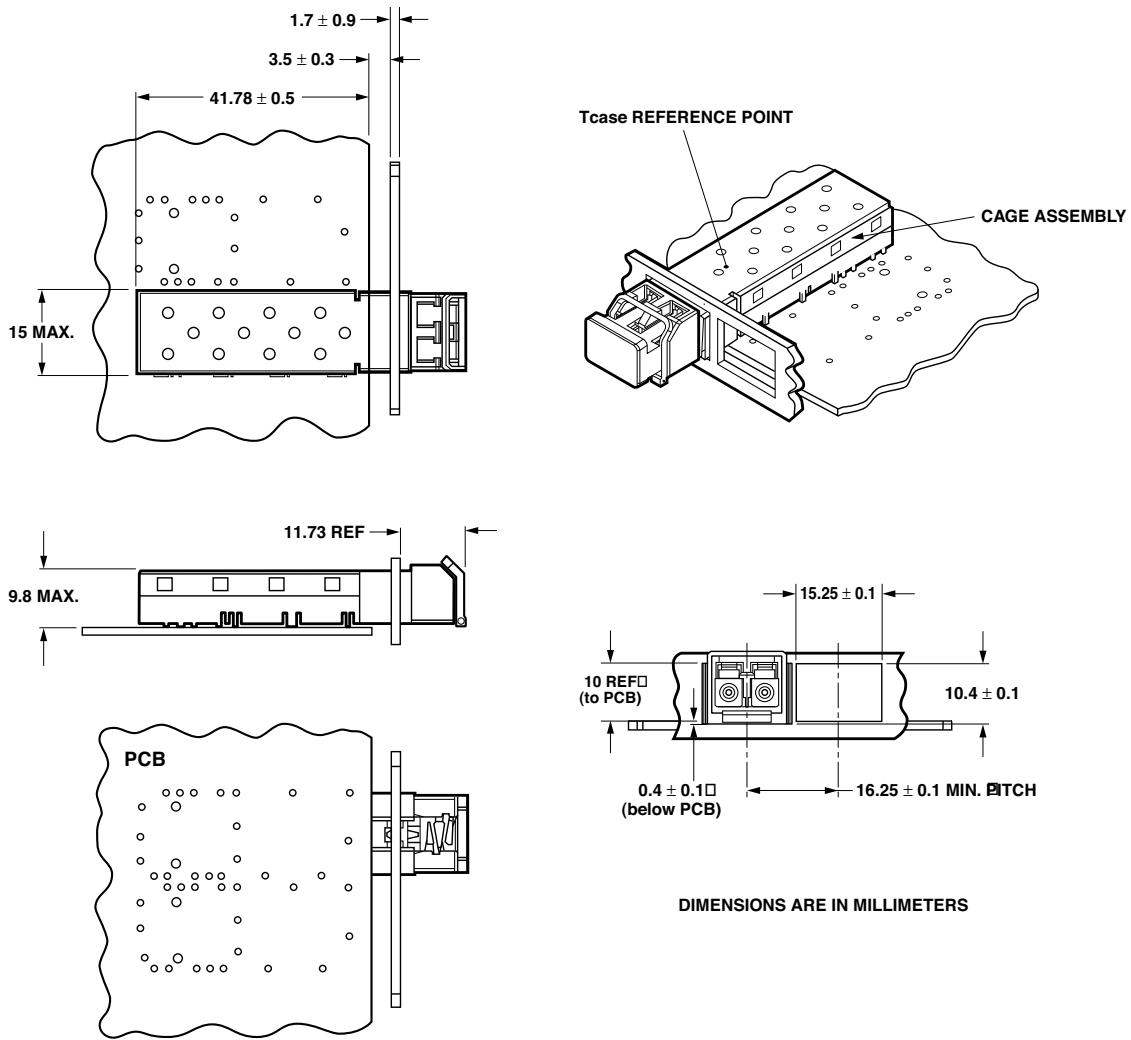

Figure 7. SFP assembly drawing.

Customer Manufacturing Processes

This module is pluggable and is not designed for aqueous wash, IR reflow, or wave soldering processes.

For product information and a complete list of distributors, please go to our website: www.avagotech.com

Avago, Avago Technologies, and the A logo are trademarks of Avago Technologies in the United States and other countries. Data subject to change. Copyright © 2005–2012 Avago Technologies. All rights reserved. Obsoletes AV01-0436EN AV02-0435EN - September 12, 2012

