

# ACPM-7331-OR1

## UMTS1900 4x4 Power Amplifier Module

(1850-1910 MHz)



### Data Sheet

#### Description

The ACPM-7331, a Wide-band Code Division Multiple Access (WCDMA) Power Amplifier (PA), is a fully matched 10-pin surface mount module developed for WCDMA handset applications. This power amplifier module operates in the 1850-1910MHz bandwidth. The ACPM-7331 meets the stringent WCDMA linearity requirements for output power of up to 28.5dBm. The ACPM-7331 is also developed to meet HSDPA specs.

The ACPM-7331 is designed to enhance the efficiency at low and medium output power range by using 3-mode control scheme with 2 mode control pins. This provides extended talk time.

The ACPM-7331 is self contained, incorporating 50ohm input and output matching networks.

#### Features

- Excellent Linearity
- Low quiescent current
- High Efficiency
  - PAE at 28.5dBm: 33.5%
  - PAE at 16dBm: 19.1%
  - PAE at 8dBm: 7.0%
- 10-pin surface mounting package (4mmx4mmx1.1mm)
- Internal 50ohm matching networks for both RF input and output
- RoHS Compliant

#### Order information

Part Number	No. of Devices	Container
ACPM-7331-OR1	1000	7" Tape and Reel
ACPM-7331-BLKR	100	BULK

#### Applications

- WCDMA Handset (HSDPA)

#### Functional Block Diagram

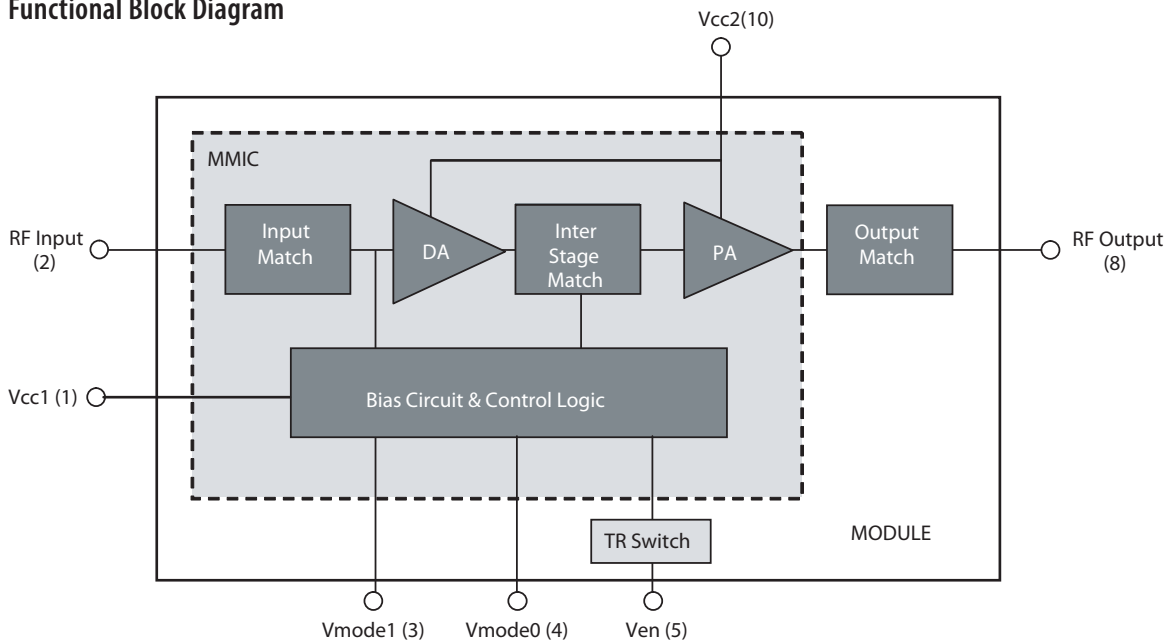

**Table 1. Absolute Maximum Ratings** <sup>[1]</sup>

Parameter	Symbol	Min	Nominal	Max	Unit
RF Input Power	Pin	–	–	10.0	dBm
DC Supply Voltage	Vcc	0	3.4	5.0	V
Enable Voltage	Ven	0	2.6	3.3	V
Mode Control Voltage	Vmode0	0	2.6	3.3	V
	Vmode1	0	2.6	3.3	V
Storage Temperature	Tstg	-55	–	+125	°C

**Table 2. Recommended Operating Condition**

Parameter	Symbol	Min	Nominal	Max	Unit
DC Supply Voltage	Vcc	3.2	3.4	4.2	V
PA Enable	Ven	1.9	2.6	2.9	V
Mode Control Voltage – High Power Mode	Vmode0	0	0	0.5	V
	Vmode1	0	0	0.5	V
– Mid Power Mode	Vmode0	1.9	2.6	2.9	V
	Vmode1	0	0	0.5	V
– Low Power Mode	Vmode0	1.9	1.9	2.9	V
	Vmode1	1.9	1.9	2.9	V
Operating Frequency	Fo	1850		1910	MHz
Case Operating Temperature	To	-20	25	90	°C

**Table 3. Power Range Truth Table** <sup>[2]</sup>

Power Mode	Symbol	Ven	Vmode0	Vmode1	Range
High Power Mode	PR3	High	Low	Low	~ 28.5dBm
Mid Power Mode	PR2	High	High	Low	~ 16dBm
Low Power Mode	PR1	High	High	High	~ 8dBm
Shut Down Mode	–	Low	–	-	–

Notes:

1. No damage assuming only one parameter is set at limit at a time with all other parameters set at or below nominal value.
2. High (1.9–2.9V), Low (0.0V–0.5V).

**Table 4. Electrical Characteristics for WCDMA Mode (Vcc=3.4V, Ven=2.6V, T=25°C, Zin/Zout=50ohm) [1]**

Characteristics	Symbol	Condition	Min.	Typ.	Max.	Unit	
Operating Frequency Range	F		1850	–	1910	MHz	
Gain	Gain_hi	High Power Mode, Pout=28.5 dBm	24	28		dB	
	Gain_mid	Mid Power Mode, Pout=16.0 dBm	13.5	16.5		dB	
	Gain_low	Low Power Mode, Pout=8.0 dBm	13	16		dB	
Power Added Efficiency	PAE_hi	High Power Mode, Pout=28.5 dBm	30.1	33.5		%	
	PAE_mid	Mid Power Mode, Pout=16.0 dBm	14.9	19.1		%	
	PAE_low	Low Power Mode, Pout=8.0 dBm	4.9	7.0		%	
Total Supply Current	lcc_hi	High Power Mode, Pout=28.5 dBm		620	690	mA	
	lcc_mid	Mid Power Mode, Pout=16.0 dBm		60	77	mA	
	lcc_low	Low Power Mode, Pout=8.0 dBm		26	37	mA	
Quiescent Current	lq_hi	High Power Mode		91	120	mA	
	lq_mid	Mid Power Mode		14	22	mA	
	lq_low	Low Power Mode		12	18	mA	
Enable Current	len_hi	High Power Mode		0.18	1	mA	
	len_mid	Mid Power Mode		0.18	1	mA	
	len_low	Low Power Mode		0.18	1	mA	
Control Current	lmode0_mid	Mid Power Mode		0.4	1	mA	
	lmode1_low	Low Power Mode		0.18	1	mA	
	lmode0_low	Low Power Mode		0.4	1	mA	
Total Current in Power-down mode	lpd	Ven=0V		0.2	5	µA	
Adjacent Channel Leakage Ratio [2]	5 MHz offset	ACL1_hi	High Power Mode, Pout=28.5 dBm		-40	-37	dBc
		ACL2_hi			-54	-46	dBc
	10 MHz offset	ACL1_mid	Mid Power Mode, Pout=16.0 dBm		-41	-36	dBc
		ACL2_mid			-56	-46	dBc
	5 MHz offset	ACL1_low	Low Power Mode, Pout=8.0 dBm		-41	-37	dBc
		ACL2_low			-57	-46	dBc
Harmonic Sup- pression	Second	2f0	High Power Mode, Pout=28.5 dBm		-35	-30	dBc
	Third	3f0			-70	-50	dBc
Input VSWR	VSWR			1.4:1	2.0:1		
Stability (Spurious Output)	S	VSWR 6:1, All phase			-60	dBc	
Noise Power in Rx Band	RxBN	High Power Mode, Pout=28.5 dBm		-136	-133	dBm/ Hz	
Phase Discontinuity	PDlow_mid	low power mode<-->mid power mode, at Pout=8dBm			10	Deg	
	PDmid_high	mid power mode<-->high power mode, at Pout=16dBm			15	Deg	
Ruggedness	Ru	Pout<28.5dBm, Pin<10dBm, All phase High Power Mode			10:1	VSWR	

Notes:

1. Electrical characteristics are specified under WCDMA modulated ( 3GPP Uplink DPCCCH + 1DPDCH ) signal
2. ACP is expressed as a ratio of total adjacent power to signal power, both with 3.84MHz bandwidth at specified offsets.

**Table 5. Electrical Characteristics for HSDPA Mode (Vcc=3.4V, Ven=2.6V, T=25°C, Zin/Zout=50ohm) [1]**

Characteristics		Symbol	Condition	Min.	Typ.	Max.	Unit
Operating Frequency Range		F		1850	–	1910	MHz
Gain		Gain_hih	High Power Mode, Pout=28.5 dBm	24	28		dB
		Gain_midh	Mid Power Mode, Pout=16.0 dBm	13.5	16.5		dB
		Gain_lowh	Low Power Mode, Pout=8.0 dBm	13	16		dB
Power Added Efficiency		PAE_hih	High Power Mode, Pout=28.5 dBm	31.0	34.6		%
		PAE_midh	Mid Power Mode, Pout=16.0 dBm	15.3	19.7		%
		PAE_lowh	Low Power Mode, Pout=8.0 dBm	4.9	7.0		%
Total Supply Current		icc_hih	High Power Mode, Pout=28.5 dBm		600	670	mA
		icc_midh	Mid Power Mode, Pout=16.0 dBm		58	75	mA
		icc_lowh	Low Power Mode, Pout=8.0 dBm		26	37	mA
Adjacent Channel Leakage Ratio [2]	5 MHz offset	ACLR1_hih	High Power Mode, Pout=28.5 dBm	–	-39	-37	dBc
	10 MHz offset	ACLR2_hih			-54	-46	dBc
	5 MHz offset	ACLR1_midh	Mid Power Mode, Pout=16.0 dBm	–	-40	-36	dBc
	10 MHz offset	ACLR2_midh			-56	-46	dBc
	5 MHz offset	ACLR1_lowh	Low Power Mode, Pout=8.0 dBm	–	-40	-37	dBc
	10 MHz offset	ACLR2_lowh			-56	-46	dBc

Notes:

1. Electrical characteristics are specified under HSDPA modulated Up-Link signal (DPCCH/DPDCH=12/15, HS-DPCCH/DPDCH=15/15)
2. ACP is expressed as a ratio of total adjacent power to signal power, both with 3.84MHz bandwidth at specified offsets

Characteristics Data (WCDMA,  $V_{cc}=3.4V$ ,  $V_{en}=2.6V$ ,  $T=25^{\circ}C$ ,  $C_{Zin}/Z_{out}=50\Omega$ )

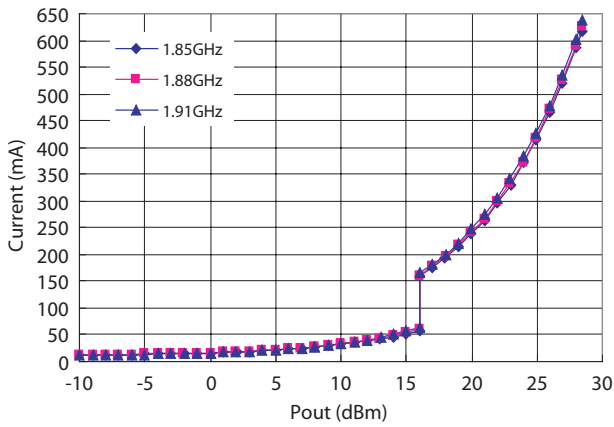

Figure 1. Total Current vs. Output Power

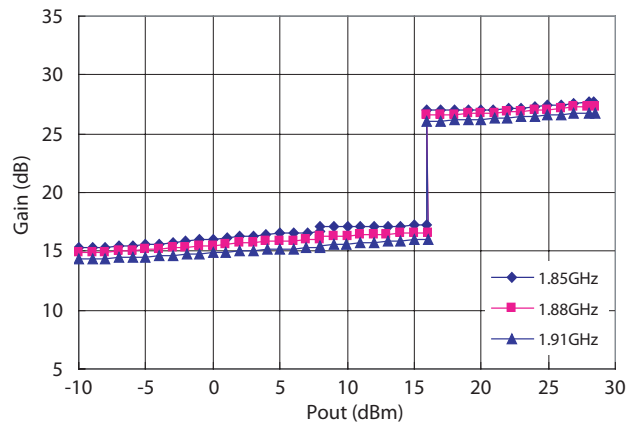

Figure 2. Gain vs. Output Power

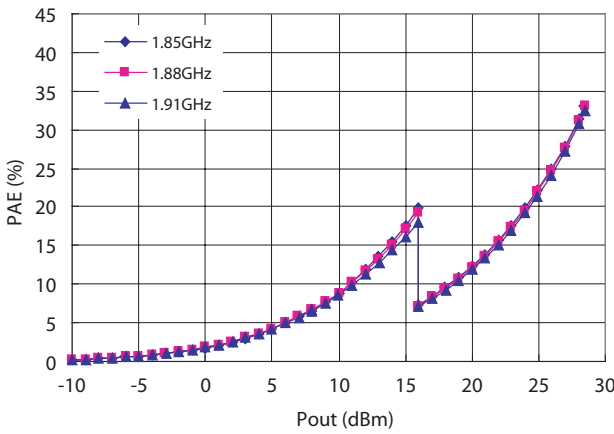

Figure 3. Power Added Efficiency vs. Output Power

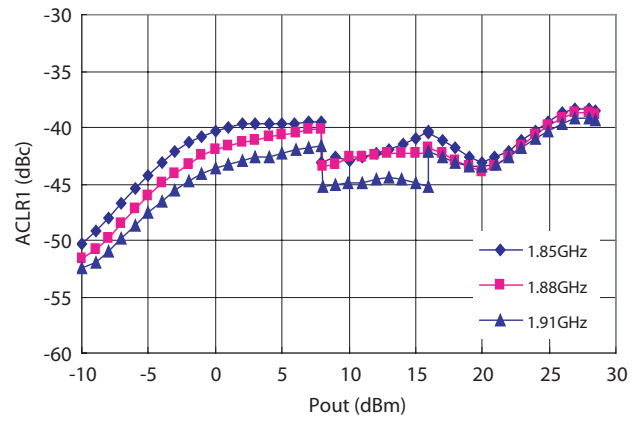

Figure 4. Adjacent Channel Leakage Ratio 1 vs. Output Power

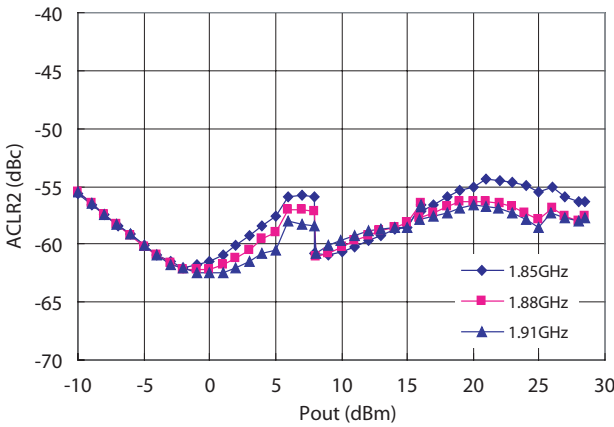

Figure 5. Adjacent Channel Leakage Ratio 2 vs. Output Power

Characteristics Data (HSDPA,  $V_{cc}=3.4V$ ,  $V_{en}=2.6V$ ,  $T=25^{\circ}C$ ,  $Z_{in}/Z_{out}=50\Omega$ )

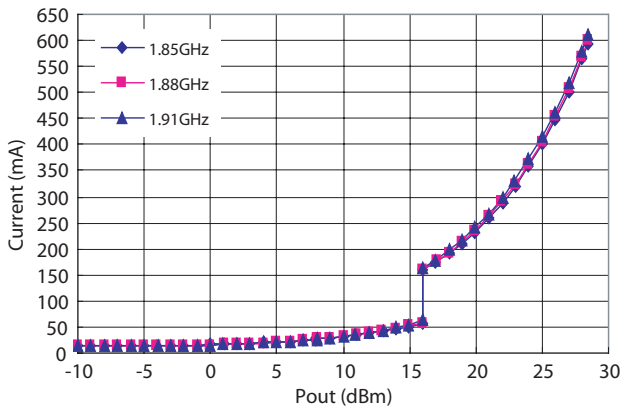

Figure 6. Total Current vs. Output Power

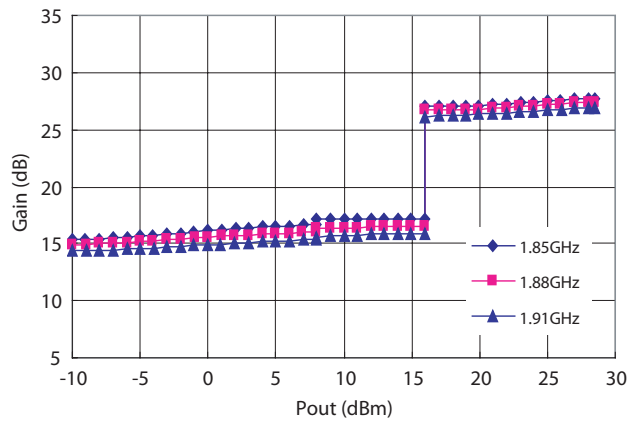

Figure 7. Gain vs. Output Power

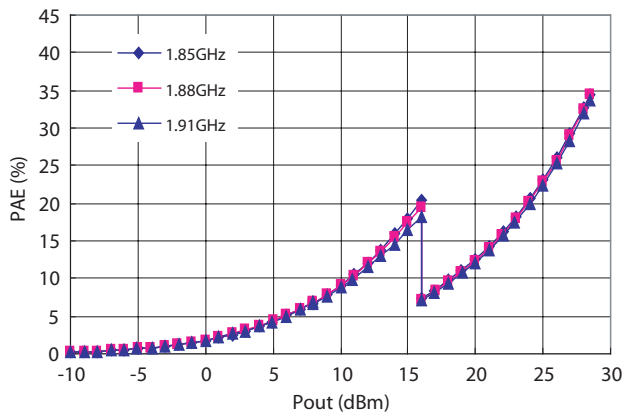

Figure 8. Power Added Efficiency vs. Output Power

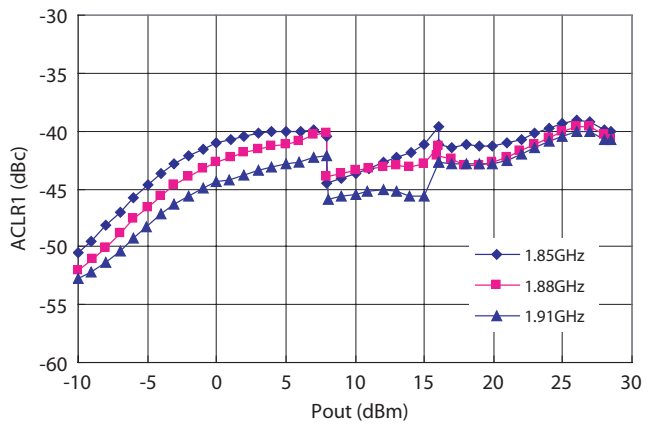

Figure 9. Adjacent Channel Leakage Ratio 1 vs. Output Power

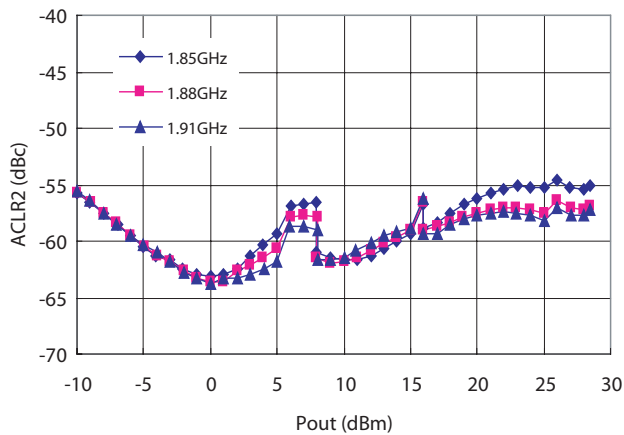

Figure 10. Adjacent Channel Leakage Ratio 2 vs. Output Power

## Evaluation Board Description

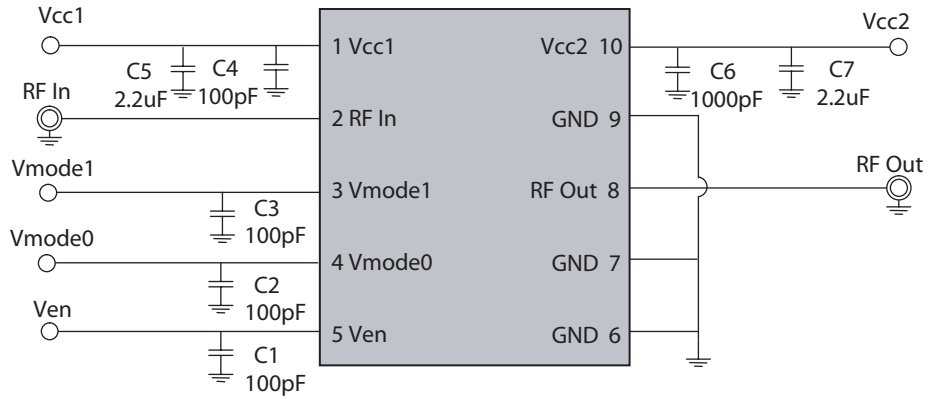

Figure 11. Evaluation Board Schematic

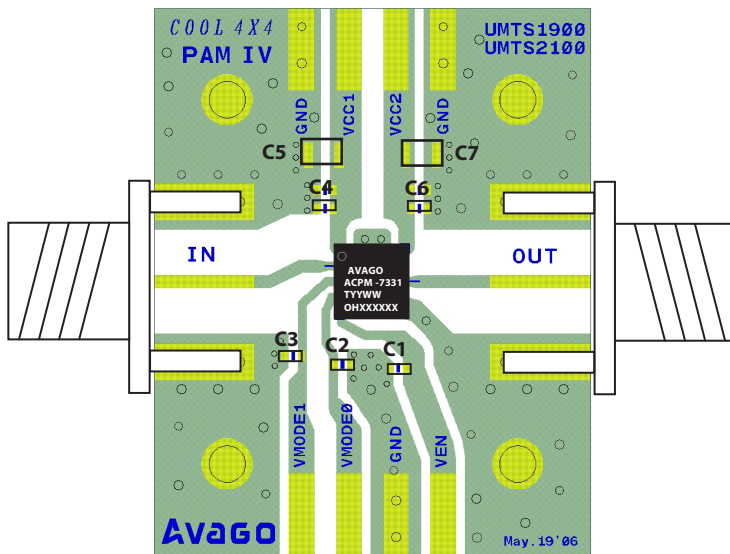

Figure 12. Evaluation Board Assembly Diagram

### Package Dimensions and Pin Descriptions

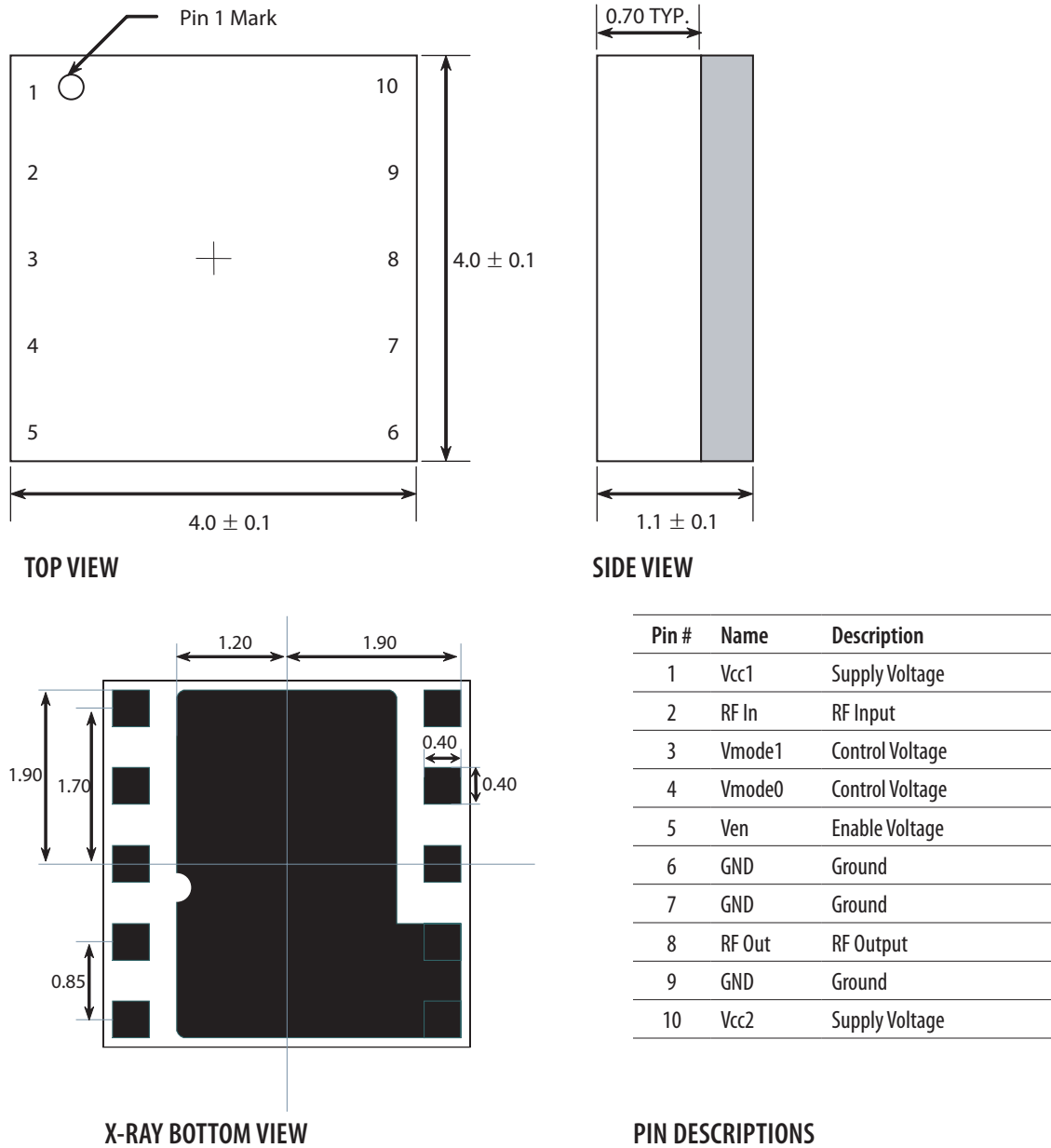

Figure 13. Package Dimensional Drawing and Pin Descriptions (All dimensions are in millimeters)

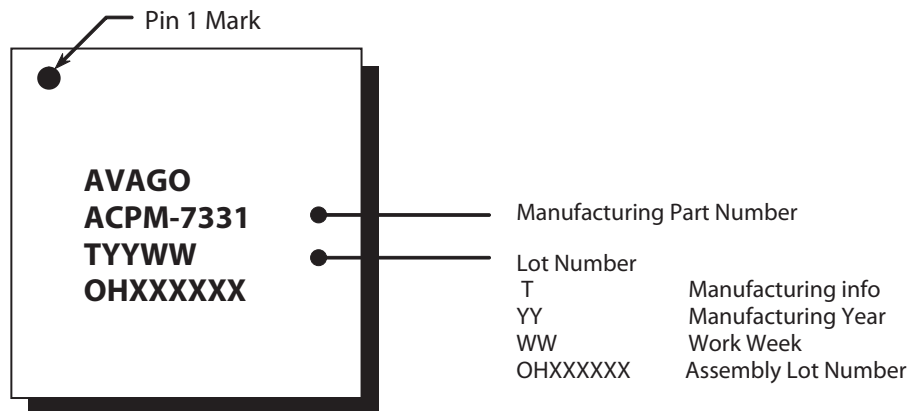

Figure 14. Marking Specifications



## PCB Design Guidelines

The recommended ACPM-7331 PCB land pattern is shown in Figure 15 and Figure 16. The substrate is coated with solder mask between the I/O and conductive paddle to protect the gold pads from short circuit that is caused by solder bleeding/bridging.

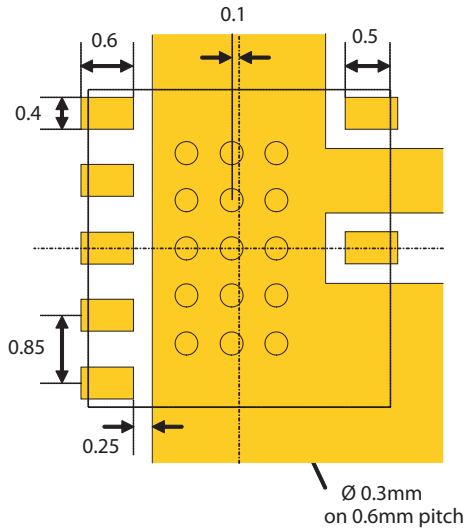

Figure 15. Metallization

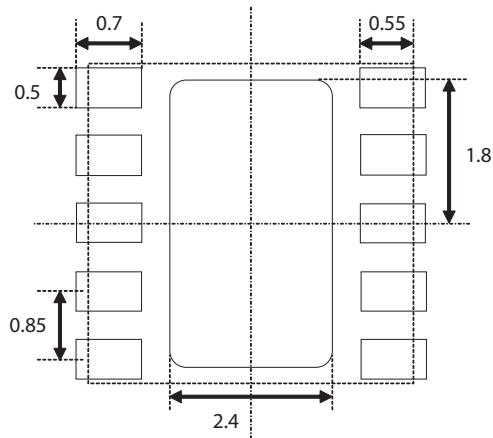

Figure 16. Solder Mask Opening

## Stencil Design Guidelines

A properly designed solder screen or stencil is required to ensure optimum amount of solder paste is deposited onto the PCB pads. The recommended stencil layout is shown in Figure 17. Reducing the stencil opening can potentially generate more voids. On the other hand, stencil openings larger than 100% will lead to excessive solder paste smear or bridging across the I/O pads or conductive paddle to adjacent I/O pads. Considering the fact that solder paste thickness will directly affect the quality of the solder joint, a good choice is to use laser cut stencil composed of 0.10mm(4mils) or 0.127mm(5mils) thick stainless steel which is capable of producing the required fine stencil outline.

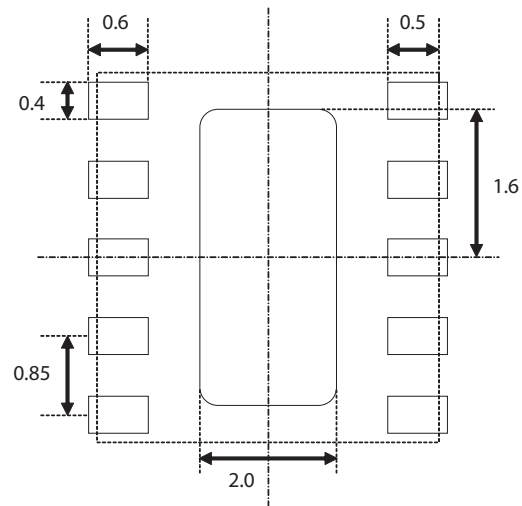
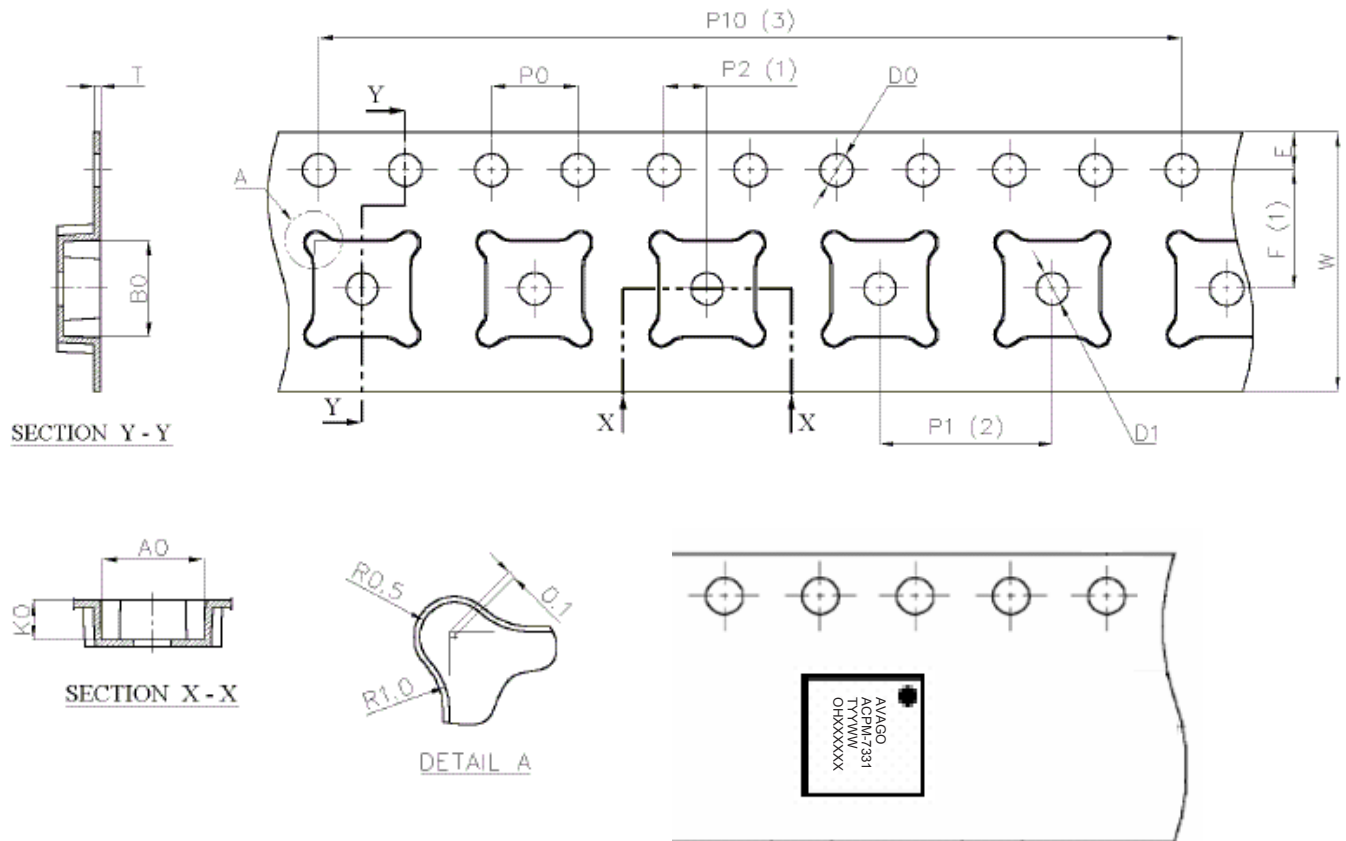

Figure 17. Solder Paste Stencil Aperture

## Tape and Reel Information



### Dimension List

Dimension	Millimeter
A0	4.40±0.10
B0	4.40±0.10
K0	1.70±0.10
D0	1.55±0.05
D1	1.60±0.10
P0	4.00±0.10
P1	8.00±0.10

Dimension	Millimeter
P2	2.00±0.05
P10	40.00±0.20
E	1.75±0.10
F	5.50±0.05
W	12.00±0.30
T	0.30±0.05

Figure 18. Tape and Reel Format – 4 mm x 4 mm.

## Reel Drawing

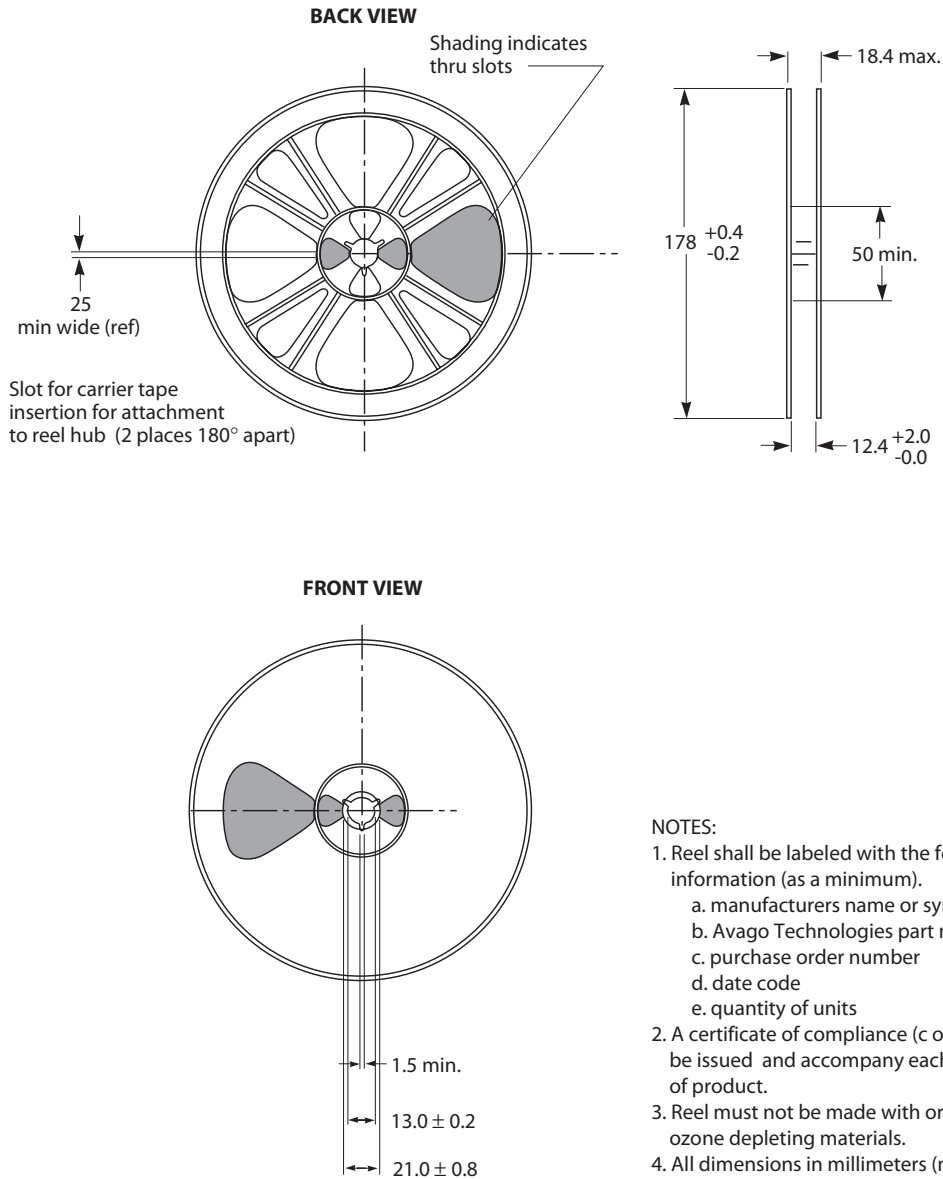

Figure 19. Plastic Reel Format (all dimensions are in millimeters)

## Handling and Storage

### ESD (Electrostatic Discharge)

Electrostatic discharge occurs naturally in the environment. With the increase in voltage potential, the outlet of neutralization or discharge will be sought. If the acquired discharge route is through a semiconductor device, destructive damage will result.

ESD countermeasure methods should be developed and used to control potential ESD damage during handling in a factory environment at each manufacturing site.

### MSL (Moisture Sensitivity Level)

Plastic encapsulated surface mount package is sensitive to damage induced by absorbed moisture and temperature.

Avago Technologies follows JEDEC Standard J-STD 020B. Each component and package type is classified for moisture sensitivity by soaking a known dry package at various temperatures and relative humidity, and times. After soak, the components are subjected to three consecutive simulated reflows.

The out of bag exposure time maximum limits are determined by the classification test describe below which corresponds to a MSL classification level 6 to 1 according to the JEDEC standard IPC/JEDEC J-STD-020B and J-STD-033.

ACPM-7331 is MSL3. Thus, according to the J-STD-033 p.11 the maximum Manufacturers Exposure Time (MET) for this part is 168 hours. After this time period, the part would need to be removed from the reel, de-taped and then re-baked. MSL classification reflow temperature for the ACPM-7331 is targeted at 260°C +0/-5°C. Figure 20 and Table 8 show typical SMT profile for maximum temperature of 260 +0/-5°C.

Table 6. ESD Classification

Pin #	Name	Description	HBM	CDM	Classification
1	Vcc1	Supply Voltage	± 2000V	± 200V	Class 2
2	RF In	RF Input	± 2000V	± 200V	Class 2
3	Vmode1	Control Voltage	± 2000V	± 200V	Class 2
4	Vmode0	Control Voltage	± 2000V	± 200V	Class 2
5	Ven	Enable Voltage	± 2000V	± 200V	Class 2
6	GND	Ground	± 2000V	± 200V	Class 2
7	GND	Ground	± 2000V	± 200V	Class 2
8	RF Out	RF Output	± 2000V	± 200V	Class 2
9	GND	Ground	± 2000V	± 200V	Class 2
10	Vcc2	Supply Voltage	± 2000V	± 200V	Class 2

Note :

1. Module products should be considered extremely ESD sensitive.

Table 7. Moisture Classification Level and Floor Life

MSL Level	Floor Life (out of bag) at factory ambient =< 30°C/60% RH or as stated
1	Unlimited at =< 30°C/85% RH
2	1 year
2a	4 weeks
3	168 hours
4	72 hours
5	48 hours
5a	24 hours
6	Mandatory bake before use. After bake, must be reflowed within the time limit specified on the label

Note :

1. The MSL Level is marked on the MSL Label on each shipping bag.

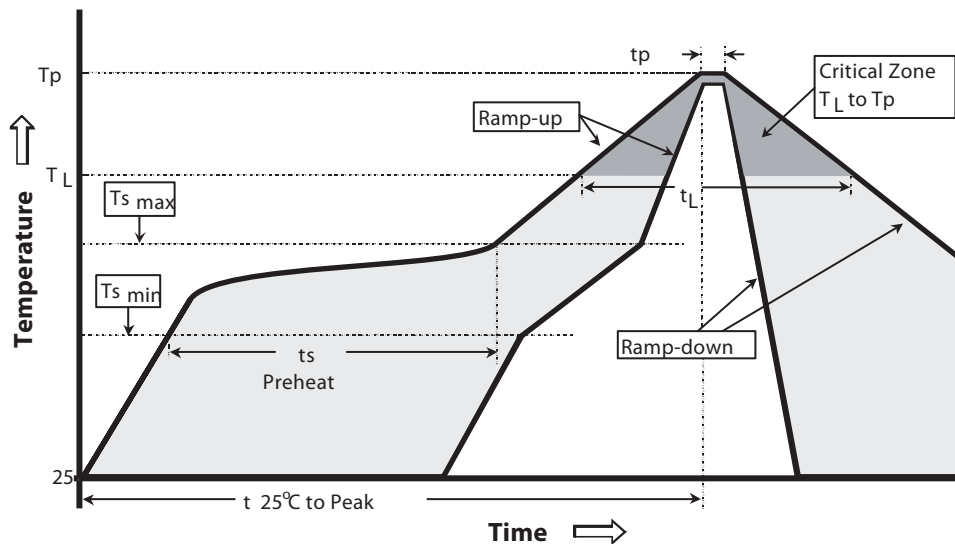

Figure 20. Typical SMT Reflow Profile for Maximum Temperature =  $260 \pm 0/-5^{\circ}\text{C}$

Table 8. Typical SMT Reflow Profile for Maximum Temperature =  $260 \pm 0 / -5^{\circ}\text{C}$

Profile Feature	Sn-Pb Solder	Pb-Free Solder
Average ramp-up rate (TL to TP)	$3^{\circ}\text{C}/\text{sec max}$	$3^{\circ}\text{C}/\text{sec max}$
Preheat		
- Temperature Min (T <sub>smin</sub> )	$100^{\circ}\text{C}$	$150^{\circ}\text{C}$
- Temperature Max (T <sub>smax</sub> )	$150^{\circ}\text{C}$	$200^{\circ}\text{C}$
- Time (min to max) (t <sub>s</sub> )	60-120 sec	60-180 sec
T <sub>smax</sub> to TL		
- Ramp-up Rate		$3^{\circ}\text{C}/\text{sec max}$
Time maintained above:		
- Temperature (TL)	$183^{\circ}\text{C}$	$217^{\circ}\text{C}$
- Time (TL)	60-150 sec	60-150 sec
Peak temperature (T <sub>p</sub> )	$240 \pm 0/-5^{\circ}\text{C}$	$260 \pm 0/-5^{\circ}\text{C}$
Time within $5^{\circ}\text{C}$ of actual Peak Temperature (t <sub>p</sub> )	10-30 sec	20-40 sec
Ramp-down Rate	$6^{\circ}\text{C}/\text{sec max}$	$6^{\circ}\text{C}/\text{sec max}$
Time $25^{\circ}\text{C}$ to Peak Temperature	6 min max.	8 min max.

## Storage Condition

Packages described in this document must be stored in sealed moisture barrier, antistatic bags. Shelf life in a sealed moisture barrier bag is 12 months at <40°C and 90% relative humidity (RH) J-STD-033 p.7.

## Out-of-Bag Time Duration

After unpacking the device must be soldered to the PCB within 168 hours as listed in the J-STD-020B p.11 with factory conditions <30°C and 60% RH.

## Baking

It is not necessary to re-bake the part if both conditions (storage conditions and out-of bag conditions) have been satisfied. Baking must be done if at least one of the conditions above have not been satisfied. The baking conditions are 125°C for 12 hours J-STD-033 p.8.

## CAUTION

Tape and reel materials typically cannot be baked at the temperature described above. If out-of-bag exposure time is exceeded, parts must be baked for a longer time at low temperatures, or the parts must be de-reeled, de-taped, re-baked and then put back on tape and reel. (See moisture sensitive warning label on each shipping bag for information of baking).

## Board Rework

### Component Removal, Rework and Remount

If a component is to be removed from the board, it is recommended that localized heating be used and the maximum body temperatures of any surface mount component on the board not exceed 200°C. This method will minimize moisture related component damage. If any component temperature exceeds 200°C, the board must be baked dry per 4-2 prior to rework and/or component removal. Component temperatures shall be measured at the top center of the package body. Any SMD packages that have not exceeded their floor life can be exposed to a maximum body temperature as high as their specified maximum reflow temperature.

### Removal for Failure Analysis

Not following the above requirements may cause moisture/reflow damage that could hinder or completely prevent the determination of the original failure mechanism.

## Baking of Populated Boards

Some SMD packages and board materials are not able to withstand long duration bakes at 125°C. Examples of this are some FR-4 materials, which cannot withstand a 24 hr bake at 125°C. Batteries and electrolytic capacitors are also temperature sensitive. With component and board temperature restrictions in mind, choose a bake temperature from Table 4-1 in J-STD 033; then determine the appropriate bake duration based on the component to be removed. For additional considerations see IPC-7711 and IPC-7721.

## Derating due to Factory Environmental Conditions

Factory floor life exposures for SMD packages removed from the dry bags will be a function of the ambient environmental conditions. A safe, yet conservative, handling approach is to expose the SMD packages only up to the maximum time limits for each moisture sensitivity level as shown in Table 7. This approach, however, does not work if the factory humidity or temperature is greater than the testing conditions of 30°C/60% RH. A solution for addressing this problem is to derate the exposure times based on the knowledge of moisture diffusion in the component package materials ref. JESD22-A120). Recommended equivalent total floor life exposures can be estimated for a range of humidities and temperatures based on the nominal plastic thickness for each device.

Table 9 lists equivalent derated floor lives for humidities ranging from 20-90% RH for three temperature, 20°C, 25°C, and 30°C.

This table is applicable to SMDs molded with novolac, biphenyl or multifunctional epoxy mold compounds. The following assumptions were used in calculating Table 9:

1. Activation Energy for diffusion = 0.35eV (smallest known value).
2. For ≤60% RH, use Diffusivity =  $0.121 \exp(-0.35\text{eV}/kT)$  mm<sup>2</sup>/s (this used smallest known Diffusivity @ 30°C).
3. For >60% RH, use Diffusivity =  $1.320 \exp(-0.35\text{eV}/kT)$  mm<sup>2</sup>/s (this used largest known Diffusivity @ 30°C).

**Table 9. Recommended Equivalent Total Floor Life (days) @ 20 °C , 25°C & 30°C For ICs with Novolac, Biphenyl and Multifunctional Epoxies (Reflow at same temperature at which the component was classified)**

**Maximum Percent Relative Humidity**

Package Type and Body Thickness	Moisture Sensitivity Level	5%	10%	20%	30%	40%	50%	60%	70%	80%	90%		
Body Thickness ≥3.1 mm Including PQFPs >84 pin, PLCCs (square) All MQFPs or All BGAs ≥1 mm	Level 2a	∞	∞	∞	60	41	33	28	10	7	6	30°	
		∞	∞	∞	78	53	42	36	14	10	8	25°	
		∞	∞	∞	103	69	57	47	19	13	10	20°	
	Level 3	∞	∞	10	9	8	7	7	5	4	4	30°	
		∞	∞	13	11	10	9	9	7	6	5	25°	
		∞	∞	17	14	13	12	12	10	8	7	20°	
	Level 4	∞	5	4	4	4	3	3	3	2	2	30°	
		∞	6	5	5	5	5	4	3	3	3	25°	
		∞	8	7	7	7	7	6	5	4	4	20°	
	Level 5	∞	4	3	3	2	2	2	2	1	1	30°	
		∞	5	5	4	4	3	3	2	2	2	25°	
		∞	7	7	6	5	5	4	3	2	3	20°	
	Level 5a	∞	2	1	1	1	1	1	1	1	1	30°	
		∞	3	2	2	2	2	2	1	1	1	25°	
		∞	5	4	3	3	3	2	2	2	2	20°	
Body 2.1 mm ≤ Thickness <3.1 mm including PLCCs (rectangular) 18-32 pin SOICs (wide body) SOICs ≥20 pins, PQFPs ≤80 pins	Level 2a	∞	∞	∞	∞	86	39	28	4	3	2	30°	
		∞	∞	∞	∞	148	51	37	6	4	3	25°	
		∞	∞	∞	∞	∞	69	49	8	5	4	20°	
	Level 3	∞	∞	19	12	9	8	7	3	2	2	30°	
		∞	∞	25	15	12	10	9	5	3	3	25°	
		∞	∞	32	19	15	13	12	7	5	4	20°	
	Level 4	∞	7	5	4	4	3	3	2	2	1	30°	
		∞	9	7	5	5	4	4	3	2	2	25°	
		∞	11	9	7	6	6	5	4	3	3	20°	
	Level 5	∞	4	3	3	2	2	2	1	1	1	30°	
		∞	5	4	3	3	3	3	2	1	1	25°	
		∞	6	5	5	4	4	4	3	3	2	20°	
	Level 5a	∞	2	1	1	1	1	1	1	0.5	0.5	30°	
		∞	2	2	2	2	2	2	1	1	1	25°	
		∞	3	2	2	2	2	2	2	2	1	20°	
Body Thickness <2.1 mm including SOICs <18 pin All TQFPs, TSOPs or All BGAs <1 mm body thickness	Level 2a	∞	∞	∞	∞	∞	∞	28	1	1	1	30°	
		∞	∞	∞	∞	∞	∞	∞	∞	2	1	1	25°
		∞	∞	∞	∞	∞	∞	∞	∞	2	2	1	20°
	Level 3	∞	∞	∞	∞	∞	11	7	1	1	1	30°	
		∞	∞	∞	∞	∞	14	10	2	1	1	25°	
		∞	∞	∞	∞	∞	20	13	2	2	1	20°	
	Level 4	∞	∞	∞	9	5	4	3	1	1	1	30°	
		∞	∞	∞	12	7	5	4	2	1	1	25°	
		∞	∞	∞	17	9	7	6	2	2	1	20°	
	Level 5	∞	∞	13	5	3	2	2	1	1	1	30°	
		∞	∞	18	6	4	3	3	2	1	1	25°	
		∞	∞	26	8	6	5	4	2	2	1	20°	
	Level 5a	∞	10	3	2	1	1	1	1	1	0.5	30°	
		∞	13	5	3	2	2	2	1	1	1	25°	
		∞	18	6	4	3	2	2	2	2	1	20°	

For product information and a complete list of distributors, please go to our web site: [www.avagotech.com](http://www.avagotech.com)

Avago, Avago Technologies, and the A logo are trademarks of Avago Technologies, Limited in the United States and other countries.  
Data subject to change. Copyright © 2006 Avago Technologies Limited. All rights reserved.  
AV01-0608EN - November 21, 2006

