



Bridgelux® Décor Series™ Class A LED Array

Preliminary Product Data Sheet

Introduction

Vero



Bridgelux® Décor Series™ Class A products are a revolutionary advancement in lighting designed to match how humans perceive and prefer light. The Class A specification was created by the Lighting Research Center (LRC) behavior studies in conjunction with Bridgelux and other ASSIST members. Based on human factor response testing, the Décor Series Class A products provide vibrant, natural and brilliant looking light, evoking an emotional attraction and response. The Décor Series Class A products were developed for high-end retail, museum, architectural, premium building and hospitality applications.

Bridgelux Décor Series Class A products are available on the Vero 13 and 18 platforms. The Vero platform has been engineered with advanced connectivity options and can operate over a broad current range, enabling multiple degrees of flexibility in luminaire design optimization.

Features

- Light quality based on how humans perceive light and most preferred characteristics
- White point targeted below Black Body Curve to match preferred light quality defined in studies of human perception of light
- High Gamut Area Index and full spectrum color rendering
- Excellent light quality, matched to human preference encourages use of space
- No IR, UV or blue light peaks in spectrum
- Class A – has substantially better (broader) GAI color spectrum than Halogen
- 3000K and 4000K white color points
- Based on Bridgelux Vero CoB LED array platform
- Energy efficient lighting with long lifetime

Benefits

- Evokes a positive emotional response
- Intuitively 'feels right' for users of the space
- Bright white light
- Creates comfortable ambience
- Vibrant and vivid colors
- Bright, clean and natural looking light
- Creates stunning visual experience
- Increases visits, use of services, customer purchases and revenue generated in lighted space
- Enhances prestige of premium locations
- Does not damage artwork and fixture interiors
- Light does not discolor or age products
- Minimizes loss and wastage
- Better light quality matched to human preference
- Ideal for CDM and CMH replacement
- Industry leading light source design
- Reduces electricity, AC cooling and operating costs

Contents

Product Feature Map	2
Product Nomenclature	2
Product Selection Guide	3
Flux & Electrical Characteristics	4
Absolute Maximum Ratings	5
Performance Curves	6
Mechanical Dimensions	8
Design Resources	10
Precautions	10
Disclaimers	10
About Bridgelux	11

Product Feature Map

In addition to delivering the performance and light quality required for many lighting applications, Décor Series Class A LED arrays incorporates several

features to simplify the design integration and manufacturing process, accelerate time to market and reduce system costs.

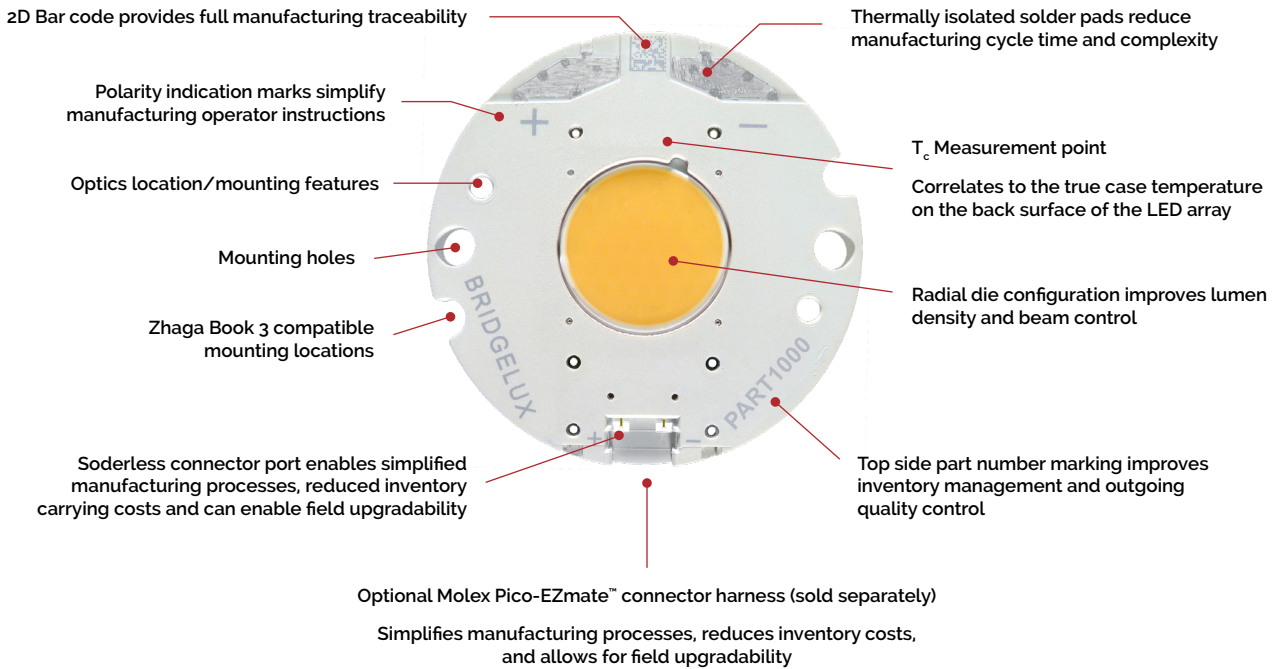

Product Nomenclature

The part number designation for Bridgelux Vero LED arrays is explained as follows:

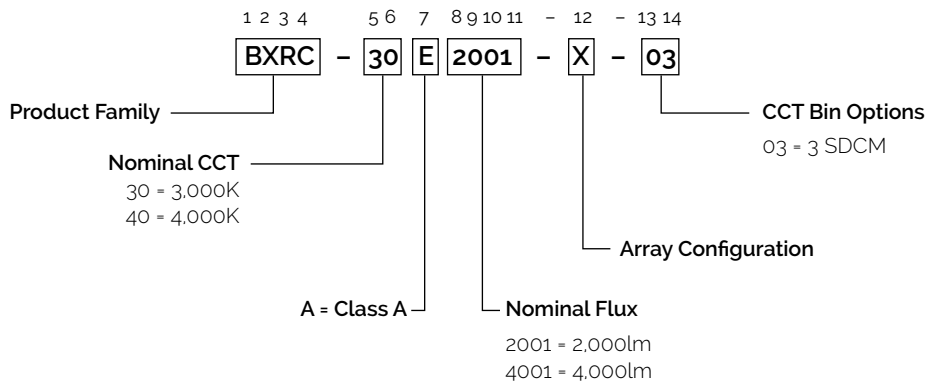

Product Selection Guide

The following product configurations are available:

Table 1: Selection Guide, Pulsed Measurement Data ($T_j = T_c = 25^\circ\text{C}$)

Part Number	Nominal CCT (K)	CRI	GAI	Nominal Drive Current ¹ (mA)	Typical Pulsed Flux ² $T_c = 25^\circ\text{C}$ (lm)	Typical V_f (V)	Typical Power (W)	Typical Efficacy (lm/W)
BXRC-30A2001-C-03	3000	80	>80	500	1360	32.3	16.2	81
BXRC-30A4001-F-03	3000	80	>80	1050	2527	29.5	31.3	82
BXRC-40A2001-C-03	4000	80	>80	500	1747	32.3	16.2	108
BXRC-40A4001-F-03	4000	80	>80	1050	3354	29.5	31.0	108

Table 2: Selection Guide, Stabilized DC Performance ($T_c = 85^\circ\text{C}$)^{3,4}

Part Number	Nominal CCT (K)	CRI	GAI	Nominal Drive Current ¹ (mA)	Typical Pulsed Flux ² $T_c = 85^\circ\text{C}$ (lm)	Typical V_f (V)	Typical Power (W)	Typical Efficacy (lm/W)
BXRC-30A2001-C-03	3000	80	>80	500	1171	31.5	15.7	74
BXRC-30A4001-F-03	3000	80	>80	1050	2249	28.8	30.2	74
BXRC-40A2001-C-03	4000	80	>80	500	1537	31.5	15.7	98
BXRC-40A4001-F-03	4000	80	>80	1050	2952	28.8	30.2	98

Notes for Tables 1 & 2:

1. Drive current is referred to as nominal drive current.
2. Bridgelux maintains a $\pm 7\%$ tolerance on flux measurements.
3. Typical stabilized DC performance values are provided as reference only and are not a guarantee of performance.
4. Typical performance is estimated based on operation under DC (direct current) with the LED array mounted to a heat sink with thermal interface material and the case temperature maintained at 85°C . Based on Bridgelux test setup, values may vary depending on the thermal design of the luminaire and/or the exposed environment to which the product is subjected.

Flux & Electrical Characteristics

Table 3: Electrical Characteristics and Driver Selection Voltages

Form Factor	Nominal Drive Current (mA) ¹	Forward Voltage Pulsed, T _c = 25°C (V) ^{1, 2, 3}			Typical Coefficient of Forward Voltage ΔV _f /ΔT (mV/°C)	Typical Thermal Resistance Junction to Case R _{j-c} (°C/W)	Driver Selection Voltages (V)	
		Minimum	Typical	Maximum			V _f Min. Hot ⁴	V _f Max. Cold ⁴
							T _c = 105°C (V)	T _c = 40°C (V)
BXRC-xxA2001-C-03	500	29.9	32.3	34.7	-14	0.78	28.8	35.6
BXRC-xxA2001-C-03	1050	32.0	35.1	37.9	-14	0.93	30.9	38.8
BXRC-xxA4001-F-03	1050	27.3	29.5	31.7	-12	0.29	26.3	32.5
BXRC-xxA4001-F-03	2100	29.2	31.6	34.2	-12	0.38	28.2	35.0

Notes for Table 3:

1. Parts are tested in pulsed conditions, T_c = 25°C. Pulse width is 10 ms.
2. Bridgelux maintains a tester tolerance of ± 0.10 V on forward voltage measurements.
3. Forward voltage minimum and maximum values at the nominal drive current (indicated in bold font) are guaranteed by 100% test. Values provided at other drive currents are provided for reference only and are not guaranteed by test.
4. V_f min hot and V_f max cold values are provided as reference only and are not guaranteed by test. These values are provided to aid in driver design and selection over the operating range of the product.
5. Thermal resistance values are based on testing data from a 3000K 80 CRI product.

Absolute Maximum Ratings

Table 4: Maximum Drive Current and Reverse Voltage Ratings

Part Number	Drive Current for LM-80 (mA) ¹	Maximum Peak Pulsed Drive Current (mA) ²	Maximum Reverse Voltage (V _r) ³
BXRC-xxA2001-C-03	1050	1500	-55
BXRC-xxA4001-F-03	2100	3000	-50

Notes for Table 4:

1. Lumen maintenance (L70) and lifetime predictions are valid for drive current and case temperature conditions used for LM-80 testing as included in the applicable LM-80 test report for these products.
2. Bridgelux recommends a maximum duty cycle of 10% when operating LED Arrays at the maximum peak pulsed current specified. Maximum peak pulsed currents indicate values where the LED array can be driven without catastrophic failures.
3. Light emitting diodes are not designed to be driven in reverse voltage and will not produce light under this condition. Maximum rating provided for reference only.

Performance Curves

Figure 1:

Drive Current vs. Forward Voltage
 $(T_j = T_c = 25^\circ\text{C}) - \text{BXRC-xxA2001-C-03}$

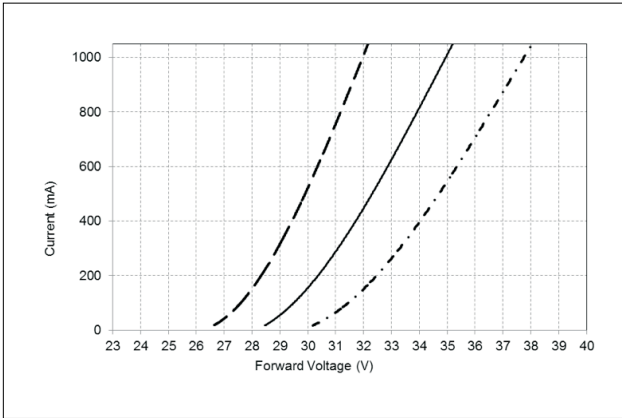

Figure 2:

Drive Current vs. Forward Voltage
 $(T_j = T_c = 25^\circ\text{C}) - \text{BXRC-xxA4001-F-03}$

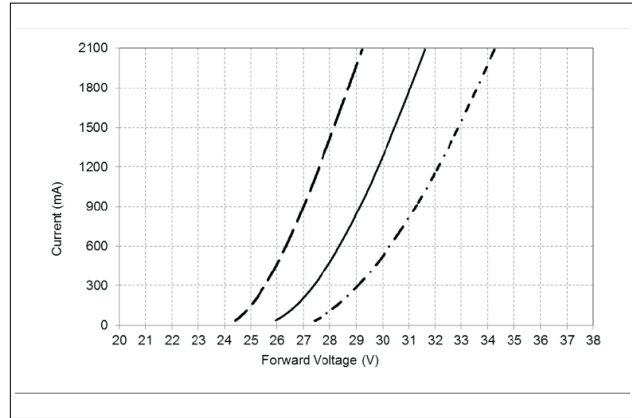

Figure 3:

Typical Relative Intensity vs. Drive Current
 BXRC-xxA2001-C-03

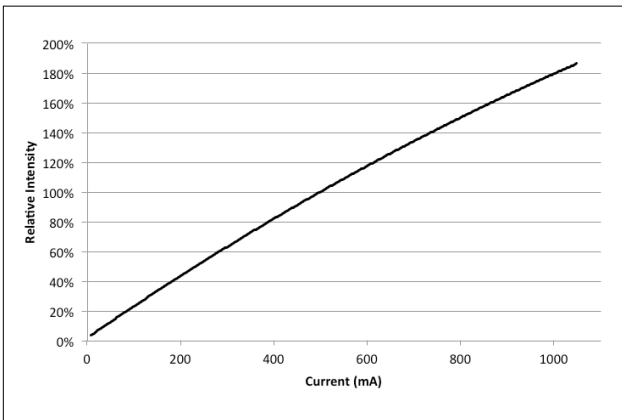
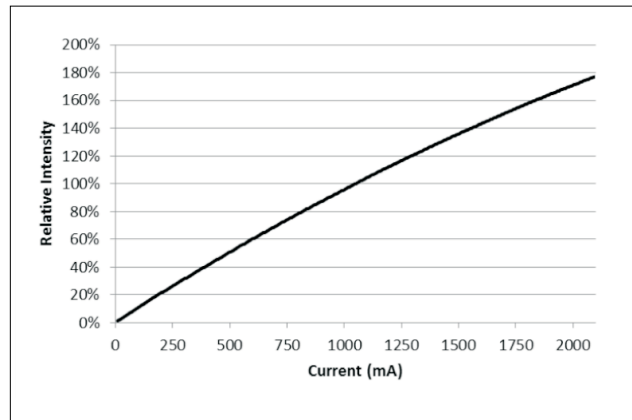

Figure 4:

Typical Relative Intensity vs. Drive Current
 BXRC-xxA4001-F-03



Performance Curves

Figure 5:

Typical Flux vs. Case Temperature

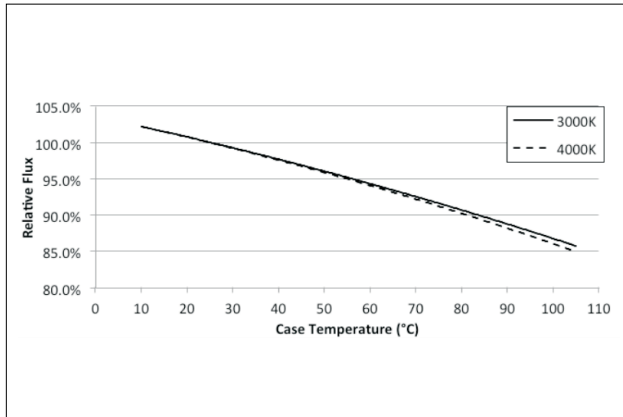

Figure 6:

Typical ccx Shift vs. Case Temperature

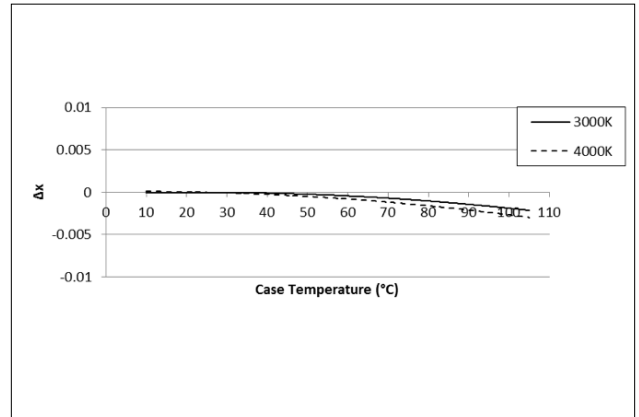
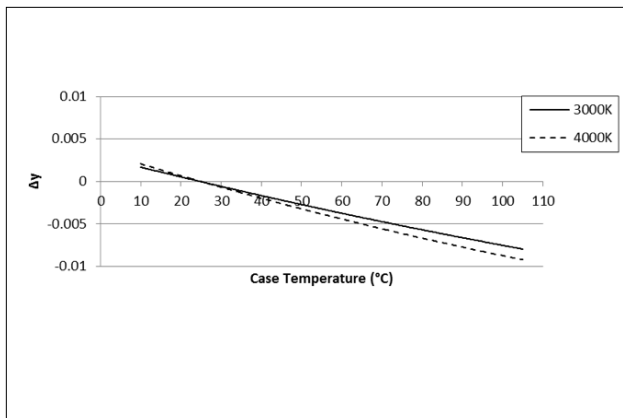

Figure 7:

Typical ccy Shift vs. Case Temperature



Mechanical Dimensions

Figure 8: Drawing for Vero 13 LED Array

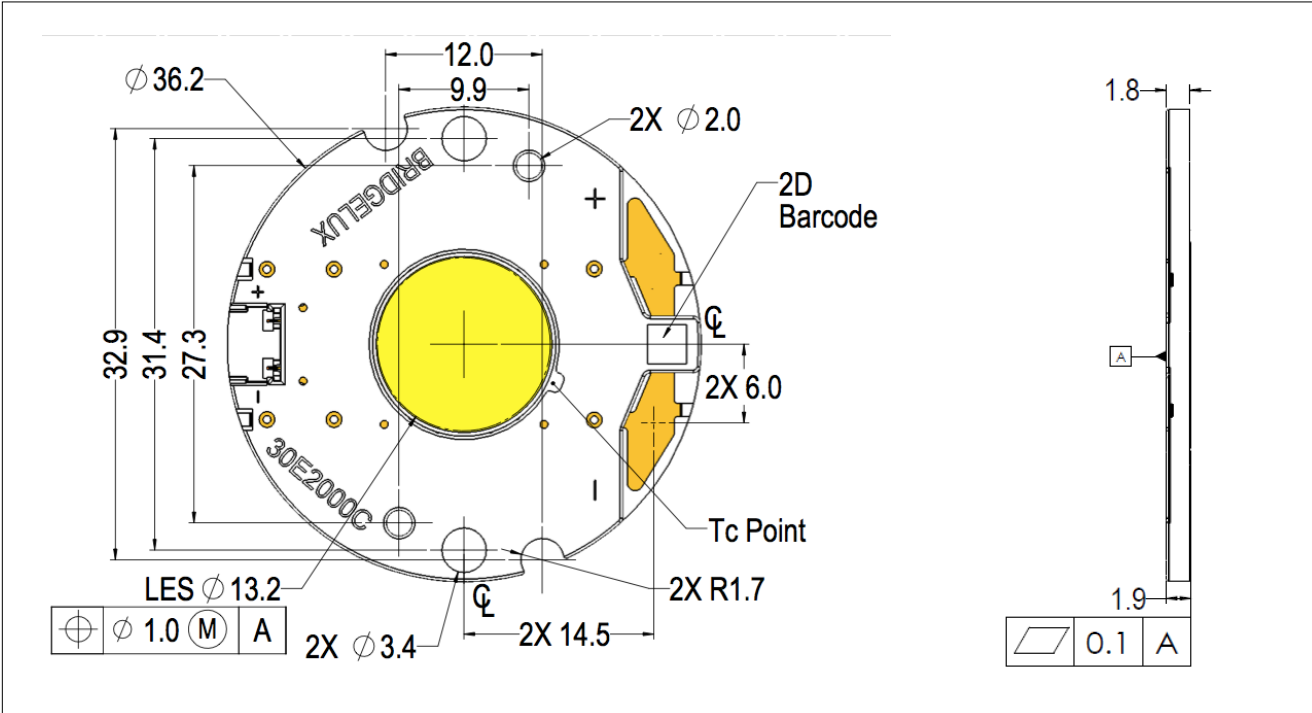

Design Resources

Application Notes

Bridgelux has developed a comprehensive set of application notes and design resources to assist customers in successfully designing with the Vero product family of LED array products. For a list of resources under development, visit www.bridgelux.com.

Optical Source Models

Optical source models and ray set files are available for all Bridgelux products. For a list of available formats, visit www.bridgelux.com.

3D CAD Models

Three dimensional CAD models depicting the product outline of all Bridgelux Vero LED arrays are available in both SAT and STEP formats. Please contact your Bridgelux sales representative for assistance.

Precautions

CAUTION: CHEMICAL EXPOSURE HAZARD

Exposure to some chemicals commonly used in luminaire manufacturing and assembly can cause damage to the LED array. Please consult Bridgelux Application Note AN31 for additional information.

CAUTION: EYE SAFETY

Eye safety classification for the use of Bridgelux Vero LED arrays is in accordance with IEC specification EN62471: Photobiological Safety of Lamps and Lamp Systems. Vero LED arrays are classified as Risk Group 1 (Low Risk) when operated at or below the maximum drive current. Please use appropriate precautions. It is important that employees working with LEDs are trained to use them safely.

CAUTION: RISK OF BURN

Do not touch the Vero LED array or yellow resin area during operation. Allow the array to cool for a sufficient period of time before handling. The Vero LED array may reach elevated temperatures such that could burn skin when touched.

CAUTION

CONTACT WITH LIGHT EMITTING SURFACE (LES)

Avoid any contact with the LES. Do not touch the LES of the LED array or apply stress to the LES (yellow phosphor resin area). Contact may cause damage to the LED array.

Optics and reflectors must not be mounted in contact with the LES (yellow phosphor resin area). Optical devices may be mounted on the top surface of the plastic housing of the Vero LED array. Use the mechanical features of the LED array housing, edges and/or mounting holes to locate and secure optical devices as needed.

Disclaimers

MINOR PRODUCT CHANGE POLICY

The rigorous qualification testing on products offered by Bridgelux provides performance assurance. Slight cosmetic changes that do not affect form, fit, or function may occur as Bridgelux continues product optimization.

About Bridgelux

Bridgelux is a leading developer and manufacturer of technologies and solutions transforming the \$40 billion global lighting industry into a \$100 billion market opportunity. Based in Livermore, California, Bridgelux is a pioneer in solid state lighting (SSL), expanding the market for light emitting diode (LED) technologies by driving down the cost of LED lighting systems. Bridgelux's patented light source technology replaces traditional technologies (such as incandescent, halogen, fluorescent and high intensity discharge lighting) with integrated, solid state lighting solutions that enable lamp and luminaire manufacturers to provide high performance and energy efficient white light for the rapidly growing interior and exterior lighting markets, including street lights, commercial lighting and consumer applications.

**For more information about the company,
please visit www.bridgelux.com.**



101 Portola Avenue
Livermore, CA 94551
Tel (925) 583-8400
Fax (925) 583-8410
www.bridgelux.com

© 2014 Bridgelux, Inc. All rights reserved 2014. Product specifications are subject to change without notice. Bridgelux, the Bridgelux stylized logo design and Vero are registered trademarks, and Decor Series is a trademark of Bridgelux, Inc. All other trademarks are the property of their respective owners.

Bridgelux Decor Series Class A Product Data Sheet (10/2014 r1)