

Bridgelux RS Array Series

Product Data Sheet DS25

**BXRA-27X-3500-F, BXRA-27X4000-H, BXRA-27x7000-J,
BXRA-30X3500-F, BXRA-30X4000-H, BXRA-30X7000-J,
BXRA-35X3500-F, BXRA-35X4000 -H, BXRA-35X7000-J,
BXRA-40X4000-F, BXRA-40E4500-H, BXRA-40E7500-J,
BXRA-5XC4500-F, BXRA-5XC5300-H, BXRA-5XC9000-J**

Introduction

The Bridgelux family of LED Array products delivers high performance, compact and cost-effective solid-state lighting solutions to serve the general lighting market. These products combine the higher efficacy, lifetime, and reliability benefits of LEDs with the light output levels of many conventional lighting sources. The Bridgelux RS Array Series has been specified to enable lamp and luminaire designs with comparable performance to existing high wattage CFL and HID conventional light sources for retail, commercial, industrial and outdoor/street lighting applications. Bridgelux Arrays are ideal for all types of light-on-demand applications, where they can be instantaneously and smoothly dimmed up or down without any effect on lifetime, unlike traditional CFL and HID light sources.

Bridgelux RS Array series are a high performance alternative to conventional solid state solutions, delivering between 3,000 and 10,000 lumens under application conditions in warm, neutral and cool white color temperatures. These compact high flux density light sources deliver uniform high quality illumination without pixilation or the multiple shadow effect caused by LED component based solutions, enabling excellent beam control for precision lighting.

LED array solutions reduce system complexity and enable miniaturized cost-effective designs. Luminaire designs incorporating these LED Arrays deliver system level performance comparable to 42-55 Watt CFL, 35-90 Watt low pressure sodium, 70-150 Watt high pressure sodium or 70-200 Watt metal halide based luminaires and feature increased system level and service life. Typical applications include retail lighting, commercial down lights, high bay, outdoor and street lights, and entertainment lighting.

Features

- Compact high flux density light source
- Uniform high quality illumination
- Minimum 70, 80 and 90 CRI options
- Streamlined thermal path
- Energy Star / ANSI compliant color binning structure with 3SDCM options
- More energy efficient than incandescent, halogen and fluorescent lamps
- Low voltage DC operation
- Instant light with unlimited dimming
- 5-Year warranty
- RoHS compliant and Pb free

Benefits

- Enhanced optical control
- Clean white light without pixilation
- High quality true color reproduction
- Significantly reduced thermal resistance and increased operating temperatures
- Uniform consistent white light
- Lower operating costs
- Increased safety
- Easy to use with daylight and motion detectors to enable increased energy savings
- Reduced maintenance costs
- Environmentally friendly, no disposal issue



Table of Contents	Page
Product Nomenclature	3
Average Lumen Maintenance Characteristics	3
IES LM-80 Test Data	3
Environmental Compliance	4
UL Recognition	4
Minor Product Change Policy	4
Cautionary Statements	4
Selection Guide	6
Color Control Options	7
Flux Characteristics	8
Optical Characteristics	9
Electrical Characteristics	10
Absolute Minimum and Maximum Ratings	11
Typical Performance at Alternative Drive Currents	12
Typical Performance at Alternative Drive Currents (continued)	13
Mechanical Dimensions	15
Typical Radiation Pattern	16
Wavelength Characteristics at Rated Test Current, $T_j=25^\circ\text{C}$	17
Typical Relative Luminous Flux vs. Current, $T_j=25^\circ\text{C}$	18
Typical Light Output Characteristics vs. Temperature	20
Forward Current Characteristics	22
Color Binning Information	24
Design Resources	27

Product Nomenclature

The part number designation for Bridgelux LED Arrays is explained as follows:

BXRA – AB C DEFG – H – IJ - KLM

Where:

BXRA – Designates product family

AB – Designates the nominal ANSI color temperature; 27 = 2700K; 30 = 3000K, etc.

C - Designates minimum CRI; C = 70, E = 80, G = 90

DEFG - Designates Nominal Flux; 4000 = 4000lm, 7000 = 7000lm, 9000 = 9000lm, etc.

H – Designates array configuration

IJ – Designates CCT Bin options

3000K as an example:

00 = Full ANSI: Q3, Q4, R3, R4

03 = 3 SDCM

KLM – Designates wire option if available

Average Lumen Maintenance Characteristics

Bridgelux projects that its family of LED Array products will deliver, on average, greater than 70% lumen maintenance after 50,000 hours of operation at the rated forward test current. This performance assumes constant current operation with case temperature maintained at or below 85°C. For use beyond these typical operating conditions please consult your Bridgelux sales representative for further assistance.

These projections are based on a combination of package test data, semiconductor chip reliability data, a fundamental understanding of package related degradation mechanisms, and performance observed from products installed in the field using Bridgelux die technology. Bridgelux conducts lumen maintenance tests per LM80. Observation of design limits is required in order to achieve this projected lumen maintenance.

IES LM-80 Test Data

Bridgelux has carried out extensive testing on multiple LED arrays according to the IES LM-80 test protocols. LM80 data is available to support all BXRA LED array products.

The IES LM-80 qualification test method is required for an LED light source. The LM-80 test method does not apply to an LED luminaire light fixture. LM-80 is a rigorous test procedure that has been designed to provide LED light source test data to support an ENERGY STAR rating for a luminaire light fixture.

When a manufacturer requires an ENERGY STAR rating for a fixture, the manufacture must have the luminaire light fixture tested to LM-79 by an accredited test facility. This test ensures that the fixture meets the photometric performance required for the ENERGY STAR rating under the specified operating conditions of the fixture.

The fixture manufacturer must provide an LM-80 report with the appropriate test data to support the operating conditions of the fixture that is to be submitted. Bridgelux can supply an LM-80 report for specific requests, contact your local Bridgelux sales representative.

Environmental Compliance

Bridgelux is committed to providing environmentally friendly products to the solid-state lighting market. Bridgelux LED Arrays comply with the European Union directives on the restriction of hazardous substances in electronic equipment, namely the RoHS directive. Bridgelux does not intentionally add the following restricted materials to LED Array products: lead, mercury, cadmium, hexavalent chromium, polybrominated biphenyls (PBB) or polybrominated diphenyl ethers (PBDE).

UL Recognition

Bridgelux secures UL Recognition for all the LED Array products. Please refer to the UL file E333389 for the latest list of UL Recognized Arrays. Bridgelux uses UL Recognized materials with suitable flammability ratings in the LED Array to streamline the process for customers to secure UL listing of the final luminaire product. Bridgelux recommends that luminaires are designed with a Class 2 Driver to facilitate the UL listing process.

Minor Product Change Policy

The rigorous qualification testing on products offered by Bridgelux provides performance assurance. Slight cosmetic changes that do not affect form, fit, or function may occur as Bridgelux continues product optimization.

Cautionary Statements

CAUTION: CONTACT WITH OPTICAL AREA

Avoid any contact with the optical area. Do not touch the optical area of the LED Array or apply stress to the yellow phosphor resin area – it could damage to the LED Array.

Optics and reflectors must not be mounted in contact with the white phosphor resin area or the white ring that surrounds the yellow phosphor area. Using the white ring to secure optics can result in damage to the LED Array as the ring is not designed to act as a mechanical locating feature. Optical devices may be mounted on the top surface of the LED Array substrate outside of the white ring maximum OD as specified in the product data sheet. Use the mechanical features of the LED Array substrate edges and/or mounting holes to locate and secure the optical device as needed.

CAUTION: EYE SAFETY

Eye safety classification for the use of Bridgelux LED Arrays is in accordance with IEC specification EN62471; Photobiological Safety of Lamps and Lamp Systems. Bridgelux LED Arrays are classified as Risk Group 1 (Low Risk) when operated at or below their rated test current. Please use appropriate precautions. It is important that employees working with LEDs are trained to use them safely.

CAUTION: RISK OF BURN

Do not touch the LED Array or resin area during operation. Allow the LED Array to cool for a sufficient period of time before handling. The LED Array may reach elevated temperatures such that it can burn skin when touched.

CAUTION: CHEMICAL EXPOSURE HAZARD

Exposure to some chemicals commonly used in luminaire manufacturing and assembly can cause damage to the LED Array. Please consult Application Note AN11 for additional information.

Case Temperature Measurement Point

A case temperature measurement point location is included on the top surface of the Bridgelux LED Arrays. The location of this measurement point is indicated in the mechanical dimensions section of this data sheet.

The purpose of this measurement point is to allow the user access to a measurement point closely linked to the true case temperature on the back surface of the LED Array. Once the LED Array is installed, it is challenging to measure the back surface of the array, or true case temperature. Measuring the top surface of the product can lead to inaccurate results due to the poor thermal conductivity of the top layers of the array such as the solder mask and other materials.

Bridgelux has provided the case temperature measurement location in a manner which closely ties it to the true case temperature of the LED Array under steady state operation. Deviations between thermal measurements taken at the point indicated and the back of the LED Array differ by less than 1 °C, providing a robust method to testing thermal operation once the product is installed.

Selection Guide

The following configurations are available. (3-step (7SDCM) color control available on certain configurations):

Table 1: Selection Guide for RS Arrays

BXRA Part Number	CCT (Nominal)	CRI (min)	Typical DC Flux T_{case}=70°C (lm)	Typical Pulsed Flux T_j=25°C (lm)	Test Current (mA)	V_f (Typ) (V)	Power (Typ) (W)	Efficacy (Typ at T _j 25°C) (lm/W)
BXRA-27E3500-F-00	2700	80	2690	3025	1750	18.2	31.8	95
BXRA-27G3500-F-00	2700	90	2280	2570	1750	18.2	31.8	81
BXRA-27E4000-H-00	2700	80	4090	4600	2100	23.5	49.4	93
BXRA-27G4000-H-00	2700	90	3550	3950	2100	23.5	49.4	80
BXRA-27E7000-J-00	2700	80	6425	7300	2800	30.5	85.4	85
BXRA-27G7000-J-00	2700	90	5520	6275	2800	30.5	85.4	73
BXRA-30E3500-F-00	3000	80	2800	3150	1750	18.2	31.8	99
BXRA-30G3500-F-00	3000	90	2450	2750	1750	18.2	31.8	86
BXRA-30E4000-H-00	3000	80	4375	4925	2100	23.5	49.4	100
BXRA-30G4000-H-00	3000	90	3730	4200	2100	23.5	49.4	85
BXRA-30E7000-J-00	3000	80	6900	7850	2800	30.5	85.4	92
BXRA-30G7000-J-00	3000	90	5900	6700	2800	30.5	85.4	78
BXRA-35E3500-F-00	3500	80	3025	3400	1750	18.2	31.8	107
BXRA-35E4000-H-00	3500	80	4710	5300	2100	23.5	49.4	107
BXRA-35E7000-J-00	3500	80	7390	8400	2800	30.5	85.4	98
BXRA-40E4000-F-00	4000	80	3130	3525	1750	18.2	31.8	111
BXRA-40E4500-H-00	4000	80	5025	5650	2100	23.5	49.4	114
BXRA-40E7500-J-00	4000	80	7830	8900	2800	30.5	85.4	104
BXRA-50C4500-F-00	5000	70	3575	4025	1750	18.2	31.8	127
BXRA-50C5300-H-00	5000	70	5585	6275	2100	23.5	49.4	127
BXRA-50C9000-J-00	5000	70	8800	10000	2800	30.5	85.4	117
BXRA-56C4500-F-00	5600	70	3580	4025	1750	18.2	31.8	127
BXRA-56C5300-H-00	5600	70	5575	6275	2100	23.5	49.4	127
BXRA-56C9000-J-00	5600	70	8800	10000	2800	30.5	85.4	117

Color Control Options

ES LED Series Arrays are available in the following color control options.

Table 2: Color Control Options

Product	CCT	CRI	7SDCM Part Number	3SDCM Part Number
RS LED Array	2700K	80	BXRA-27E3500-F-00	BXRA-27E3500-F-03
RS LED Array	2700K	90	BXRA-27G3500-F-00	BXRA-27G3500-F-03
RS LED Array	2700K	80	BXRA-27E4000-H-00	BXRA-27E4000-H-03
RS LED Array	2700K	90	BXRA-27G4000-H-00	BXRA-27G4000-H-03
RS LED Array	2700K	80	BXRA-27E7000-J-00	BXRA-27E7000-J-03
RS LED Array	2700K	90	BXRA-27G7000-J-00	BXRA-27G7000-J-03
RS LED Array	3000K	80	BXRA-30E3500-F-00	BXRA-30E3500-F-03
RS LED Array	3000K	90	BXRA-30G3500-F-00	BXRA-30G3500-F-03
RS LED Array	3000K	80	BXRA-30E4000-H-00	BXRA-30E4000-H-03
RS LED Array	3000K	90	BXRA-30G4000-H-00	BXRA-30G4000-H-03
RS LED Array	3000K	80	BXRA-30E7000-J-00	BXRA-30E7000-J-03
RS LED Array	3000K	90	BXRA-30G7000-J-00	BXRA-30G7000-J-03
RS LED Array	3500K	80	BXRA-35E3500-F-00	BXRA-35E3500-F-03
RS LED Array	3500K	80	BXRA-35E4000-H-00	BXRA-35E4000-H-03
RS LED Array	3500K	80	BXRA-35E7000-J-00	BXRA-35E7000-J-03
RS LED Array	4000K	80	BXRA-40E4000-F-00	BXRA-40E4000-F-03
RS LED Array	4000K	80	BXRA-40E4500-H-00	BXRA-40E4500-H-03
RS LED Array	4000K	80	BXRA-40E7500-J-00	BXRA-40E7500-J-03
RS LED Array	5000K	70	BXRA-50C4500-F-00	Not Available
RS LED Array	5000K	70	BXRA-50C5300-H-00	Not Available
RS LED Array	5000K	70	BXRA-50C9000-J-00	Not Available
RS LED Array	5600K	70	BXRA-56C4500-F-00	Not Available
RS LED Array	5600K	70	BXRA-56C5300-H-00	Not Available
RS LED Array	5600K	70	BXRA-56C9000-J-00	Not Available

Flux Characteristics

Table 3: Flux Characteristics

Color	ANSI CCT (K)	BXRA Part Number	CRI (min) ⁽⁴⁾	Typical DC Flux Tcase=70°C (lm) ⁽³⁾	Minimum Pulsed Flux Tj 25°C (lm) ⁽¹⁾	Typical Pulsed Flux Tj = 25°C (lm) ⁽³⁾	Test Current (mA) ⁽²⁾
Warm White	2700	BXRA-27E3500-F-00	80	2690	2720	3025	1750
		BXRA-27G3500-F-00	90	2280	2310	2570	1750
		BXRA-27E4000-H-00	80	4090	4140	4600	2100
		BXRA-27G4000-H-00	90	3550	3550	3950	2100
		BXRA-27E7000-J-00	80	6425	6570	7300	2800
		BXRA-27G7000-J-00	90	5520	5640	6275	2800
	3000	BXRA-30E3500-F-00	80	2800	2835	3150	1750
		BXRA-30G3500-F-00	90	2450	2475	2750	1750
		BXRA-30E4000-H-00	80	4375	4420	4925	2100
		BXRA-30G4000-H-00	90	3730	3775	4200	2100
		BXRA-30E7000-J-00	80	6900	7050	7850	2800
		BXRA-30G7000-J-00	90	5900	6030	6700	2800
	3500	BXRA-35E3500-F-00	80	3025	3060	3400	1750
		BXRA-35E4000-H-00	80	4710	4750	5300	2100
		BXRA-35E7000-J-00	80	7390	7550	8400	2800
Neutral White	4000	BXRA-40E4000-F-00	80	3130	3170	3525	1750
		BXRA-40E4500-H-00	80	5025	5075	5650	2100
		BXRA-40E7500-J-00	80	7830	8010	8900	2800
Cool White	5000	BXRA-50C4500-F-00	70	3575	3620	4025	1750
		BXRA-50C5300-H-00	70	5585	5640	6275	2100
		BXRA-50C9000-J-00	70	8800	9000	10000	2800
	5600	BXRA-56C4500-F-00	70	3580	3620	4025	1750
		BXRA-56C5300-H-00	70	5575	5640	6275	2100
		BXRA-56C9000-J-00	70	8800	9000	10000	2800

Notes for Table 3:

1. Bridgelux maintains a $\pm 7\%$ tolerance of flux measurements.
2. Parts are tested in pulsed conditions, $T_j = 25^\circ\text{C}$. Pulse width is 10 ms at rated test current.
3. Typical performance when driven at DC (direct current) test current with LED Array case temperature maintained at 70°C , mounted to heat sink with thermal interface material. Please contact a Bridgelux sales representative for additional details.
4. Typical R9 value for 90 CRI product options is 50.
5. Reference Table 8 and 9 for typical performance at other driver currents (including those commonly available in the market).

Optical Characteristics

Table 4: Optical Characteristics

Color	ANSI CCT (K)	BXRA Part Number	Color Temperature (CCT) ^{[1], [2], [3]}			Minimum Color Rendering Index ^[4]	Typical Viewing Angle (Degrees) $2\theta^{1/2}$ ^[5]	Typical Center Beam Candle Power (cd) ^[6]
			Min	Typ	Max			
Warm White	2700	BXRA-27E3500-F-00	2580 K	2725 K	2870 K	80	120	960
		BXRA-27G3500-F-00	2580 K	2725 K	2870 K	90	120	810
		BXRA-27E4000-H-00	2580 K	2725 K	2870 K	80	120	1460
		BXRA-27G4000-H-00	2580 K	2725 K	2870 K	90	120	1250
		BXRA-27E7000-J-00	2580 K	2725 K	2870 K	80	120	2325
		BXRA-27G7000-J-00	2580 K	2725 K	2870 K	90	120	2000
	3000	BXRA-30E3500-F-00	2870 K	3045 K	3220 K	80	120	1000
		BXRA-30G3500-F-00	2870 K	3045 K	3220 K	90	120	875
		BXRA-30E4000-H-00	2870 K	3045 K	3220 K	80	120	1560
		BXRA-30G4000-H-00	2870 K	3045 K	3220 K	90	120	1330
		BXRA-30E7000-J-00	2870 K	3045 K	3220 K	80	120	2500
		BXRA-30G7000-J-00	2870 K	3045 K	3220 K	90	120	2100
	3500	BXRA-35E3500-F-00	3220 K	3465 K	3710 K	80	120	1080
		BXRA-35E4000-H-00	3220 K	3465 K	3710 K	80	120	1675
		BXRA-35E7000-J-00	3220 K	3465 K	3710 K	80	120	2675
Neutral White	4000	BXRA-40E4000-F-00	3700 K	4000 K	4250 K	80	120	1120
		BXRA-40E4500-H-00	3700 K	4000 K	4250 K	80	120	1800
		BXRA-40E7500-J-00	3700 K	4000 K	4250 K	80	120	2830
Cool White	5000	BXRA-50C4500-F-00	5028 K	5100 K	5665 K	70	120	1280
		BXRA-50C5300-H-00	5028 K	5100 K	5665 K	70	120	2000
		BXRA-50C9000-J-00	5028 K	5100 K	5665 K	70	120	3180
	5600	BXRA-56C4500-F-00	5310 K	5665 K	6020 K	70	120	1280
		BXRA-56C5300-H-00	5310 K	5665 K	6020 K	70	120	2000
		BXRA-56C9000-J-00	5310 K	5665 K	6020 K	70	120	3180

Notes for Table 4:

1. Parts are tested in pulsed conditions, $T_j = 25^\circ\text{C}$. Pulse width is 10 ms at rated test current.
2. Refer to Flux Characteristic Table for test current data.
3. Product is binned for color in x y coordinates.
4. Viewing angle is the off axis angle from the centerline where I_v is $\frac{1}{2}$ of the peak value.
5. Center beam candle power is a calculated value based on lambertian radiation pattern at nominal test current.

Electrical Characteristics

Table 5: Electrical Characteristics

Color	Base Part Number	Forward Voltage Vf (V) ^[2]			Test Current (mA) ^[1]	Typical Coefficient of Forward Voltage (mV/°C) $\Delta V_f/\Delta T_j$	Typical Thermal Resistance Junction to Case (°C/W) $R_{\theta_{j-c}}$
		Min	Typ	Max			
Warm White	BXRA-27E3500-F-00	16.4	18.2	20.0	1750	-6 to -18	0.46
	BXRA-27G3500-F-00	16.4	18.2	20.0	1750	-6 to -18	0.46
	BXRA-27E4000-H-00	21.2	23.5	25.9	2100	-8 to -24	0.31
	BXRA-27G4000-H-00	21.2	23.5	25.9	2100	-8 to -24	0.31
	BXRA-27E7000-J-00	27.5	30.5	33.6	2800	-10 to -30	0.26
	BXRA-27G7000-J-00	27.5	30.5	33.6	2800	-10 to -30	0.26
	BXRA-30E3500-F-00	16.4	18.2	20.0	1750	-6 to -18	0.46
	BXRA-30G3500-F-00	16.4	18.2	20.0	1750	-6 to -18	0.46
	BXRA-30E4000-H-00	21.2	23.5	25.9	2100	-8 to -24	0.31
	BXRA-30G4000-H-00	21.2	23.5	25.9	2100	-8 to -24	0.31
	BXRA-30E7000-J-00	27.5	30.5	33.6	2800	-10 to -30	0.26
	BXRA-30G7000-J-00	27.5	30.5	33.6	2800	-10 to -30	0.26
	BXRA-35E3500-F-00	16.4	18.2	20.0	1750	-6 to -18	0.46
	BXRA-35E4000-H-00	21.2	23.5	25.9	2100	-8 to -24	0.31
	BXRA-35E7000-J-00	27.5	30.5	33.6	2800	-10 to -30	0.26
Neutral White	BXRA-40E4000-F-00	16.4	18.2	20.0	1750	-6 to -18	0.46
	BXRA-40E4500-H-00	21.2	23.5	25.9	2100	-8 to -24	0.31
	BXRA-40E7500-J-00	27.5	30.5	33.6	2800	-10 to -30	0.26
Cool White	BXRA-50C4500-F-00	16.4	18.2	20.0	1750	-6 to -18	0.46
	BXRA-50C5300-H-00	21.2	23.5	25.9	2100	-8 to -24	0.31
	BXRA-50C9000-J-00	27.5	30.5	33.6	2800	-10 to -30	0.26
	BXRA-56C4500-F-00	16.4	18.2	20.0	1750	-6 to -18	0.46
	BXRA-56C5300-H-00	21.2	23.5	25.9	2100	-8 to -24	0.31
	BXRA-56C9000-J-00	27.5	30.5	33.6	2800	-10 to -30	0.26

Notes for Table 5:

1. Parts are tested in pulsed conditions, $T_j = 25^\circ\text{C}$. Pulse width is 10 ms at rated test current.
2. Bridgelux maintains a tester tolerance of ± 0.10 V on forward voltage measurements.

Absolute Minimum and Maximum Ratings

Table 6: Maximum Current and Reverse Voltage Ratings

Color	Base Part Number	Maximum DC Forward Current (mA)	Maximum Peak Pulsed Current (mA) ^[1]	Maximum Reverse Voltage (Vr) ^[2]
Warm White	BXRA-XXX3500-F-00	2250	2500	-30
	BXRA-XXX4000-H-00	3000	4000	-40
	BXRA-XXX7000-J-00	3750	5000	-50
Neutral White	BXRA-40X4000-F-00	2250	2500	-30
	BXRA-XXX4500-H-00	3000	4000	-40
	BXRA-XXX7500-J-00	3750	5000	-50
Cool White	BXRA-XXX54500-F-00	2250	2500	-30
	BXRA-XXX5300-H-00	3000	4000	-40
	BXRA-XXX9000-J-00	3750	5000	-50

Notes for Table 6:

1. Bridgelux recommends a maximum duty cycle of 10% when operating LED Arrays at the maximum peak pulsed current specified.
2. Light emitting diodes are not designed to be driven in reverse voltage.

Table 7: Maximum Ratings

Parameter	Maximum Rating
LED Junction Temperature	150 °C
Storage Temperature	-40 °C to +105 °C
Operating Case Temperature	105 °C
Soldering Temperature*	350 °C or lower for a maximum of 3.5 seconds

*See Bridgelux Application Note AN15: Reflow Soldering of Bridgelux LED Arrays for solder procedure (www.Bridgelux.com)

Typical Performance at Alternative Drive Currents

Bridgelux LED Arrays may also be driven at alternative drive currents dependent on the specific application. Typical performance at any drive current can be derived from the flux vs. current characteristics (Figures 5 and 6) and current vs. voltage characteristics (Figures 10 and 11). The typical performance at common drive currents is also summarized in Tables 8 and 9.

Table 8: Typical Product Performance at Alternative Drive Currents

Color	ANSI CCT (K)	BXRA Part Number	CRI	Typ. Flux $T_{case} = 70^{\circ}C$ (lm) ^[3]	Typ. Flux $T_j = 25^{\circ}C$ (lm)	Vf	Forward Current (mA) ^[2]
Warm White	2700	BXRA-27E3500-F-00	80	2375	2640	18.2	1500
				3130	3525	18.5	1750^[1]
				3540	3580	18.7	2100
		BXRA-27G3500-F-00	90	2010	2240	18.2	1500
				2275	2570	18.5	1750^[1]
				2710	3050	18.7	2100
		BXRA-27E4000-H-00	80	2925	3250	22.8	1400
				3510	3900	23.2	1750
				4090	4600	23.5	2100^[1]
		BXRA-27G4000-H-00	90	2520	2800	22.8	1400
				3040	3380	23.2	1750
				3550	3950	23.5	2100^[1]
	BXRA-27E7000-J-00	80	4150	4610	29.0	1750	
			5000	5620	29.5	2100	
			6425	7300	30.5	2800^[1]	
	BXRA-27G7000-J-00	90	3550	3950	29.0	1750	
			4270	4800	29.5	2100	
			5520	6270	30.5	2800^[1]	
	3000	BXRA-30E3500-F-00	80	2475	2750	18.2	1500
				2800	3150	18.5	1750^[1]
				3320	3730	18.7	2100
		BXRA-30G3500-F-00	90	2150	2400	18.2	1500
				2450	2750	18.5	1750^[1]
				2900	3260	18.7	2100
BXRA-30E4000-H-00		80	3140	3490	22.8	1400	
			3780	4200	23.2	1750	
			4375	4925	23.5	2100^[1]	
BXRA-30G4000-H-00		90	2700	3000	22.8	1400	
			3270	3630	23.2	1750	
			3730	4200	23.5	2100^[1]	
BXRA-30E7000-J-00	80	4450	4940	29.0	1750		
		5350	6025	29.5	2100		
		6900	7850	30.5	2800^[1]		
BXRA-30G7000-J-00	90	3825	4250	29.0	1750		
		4610	5180	29.5	2100		
		5980	6800	30.5	2800^[1]		

Typical Performance at Alternative Drive Currents (continued)

Table 9: Typical Product Performance at Alternative Drive Currents

Color	ANSI CCT (K)	BXRA Part Number	CRI	Typ. Flux T _{case} = 70°C (lm) ^[3]	Typ. Flux T _j = 25°C (lm)	V _f	Forward Current (mA) ^[2]
Warm White	3500	BXRA-35E3500-F-00	80	2650	2950	18.2	1500
				3125	3525	18.5	1750^[1]
				3600	4050	18.7	2100
		BXRA-35E4000-H-00	80	3375	3770	22.8	1400
				4100	4550	23.2	1750
				4720	5300	23.5	2100^[1]
		BXRA-35E7000-J-00	80	4750	5275	29.0	1750
				5725	6430	29.5	2100
				7390	8400	30.5	2800^[1]
Neutral White	4000	BXRA-40E4000-F-00	80	2770	3080	18.2	1500
				3130	3525	18.5	1750^[1]
				3720	4180	18.7	2100
		BXRA-40E4500-H-00	80	3600	4010	22.8	1400
				4350	4840	23.2	1750
				5025	5650	23.5	2100^[1]
		BXRA-40E7500-J-00	90	5000	5610	29.0	1750
				6100	6840	29.5	2100
				7830	8900	30.5	2800^[1]
Cool White	5000	BXRA-50C4500-F-00	70	3150	3500	18.2	1500
				3580	4025	18.5	1750^[1]
				4240	4770	18.7	2100
		BXRA-50C5300-H-00	70	4200	4660	22.8	1400
				4840	5380	23.2	1750
				5575	6275	23.5	2100^[1]
		BXRA-50C9000-J-00	70	5600	6300	29.0	1750
				6830	7680	29.5	2100
				8800	10000	30.5	2800^[1]
	5600	BXRA-56C4500-F-00	70	3150	3500	18.2	1500
				3580	4025	18.5	1750^[1]
				4240	4770	18.7	2100
		BXRA-56C5300-H-00	70	4190	4660	22.8	1400
				4840	5380	23.2	1750
				5575	6275	23.5	2100^[1]
BXRA-56C9000-J-00	70	5600	6300	29.0	1750		
		6830	7680	29.5	2100		
		8800	10000	30.5	2800^[1]		

Notes for Table 8 and 9:

1. Product is tested and binned at the specified drive current.
2. Operating these LED Arrays at or below the drive currents listed in Tables 7 and 8, with a case temperature maintained at or below 70°C, will enable the average lumen maintenance projection outlined earlier in this Product Data Sheet.

PRELIMINARY

Mechanical Dimensions

Figure 1: Drawing for RS Arrays

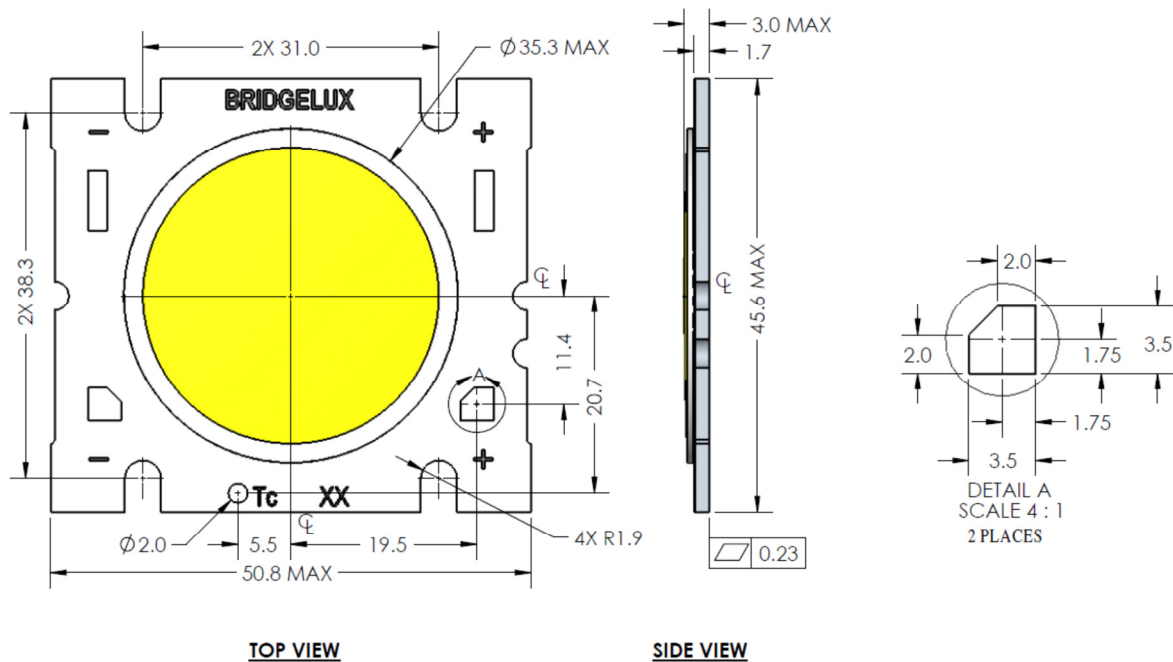

Notes for Figure 1:

1. Slots are for M2.5, M3 or #4 screws.
2. Solder pads are labeled "+" and "-" to denote positive and negative, respectively.
3. It is not necessary to provide electrical connections to both sets of solder pads. Either set of solder pads (6.35 x 2.03 mm rectangular pads or 3.50 mm tapered square pads) may be used depending on application specific design requirements.
4. Drawings are not to scale.
5. Drawing dimensions are in millimeters.
6. Bridgelux recommends four tapped holes for mounting screws – refer to product Application Note AN11 for recommended spacing of holes.
7. Unless otherwise specified, tolerances are ± 0.10 mm.
8. Refer to product Application Notes AN10 and AN11 for product handling, mounting and heat sink recommendations.
9. The optical center of the LED Array is defined by the mechanical center of the array.
10. Bridgelux maintains a flatness of 0.25 mm across the mounting surface of the array. Refer to Application Notes AN10 and AN11 for product handling, mounting and heat sink recommendations.

Typical Radiation Pattern

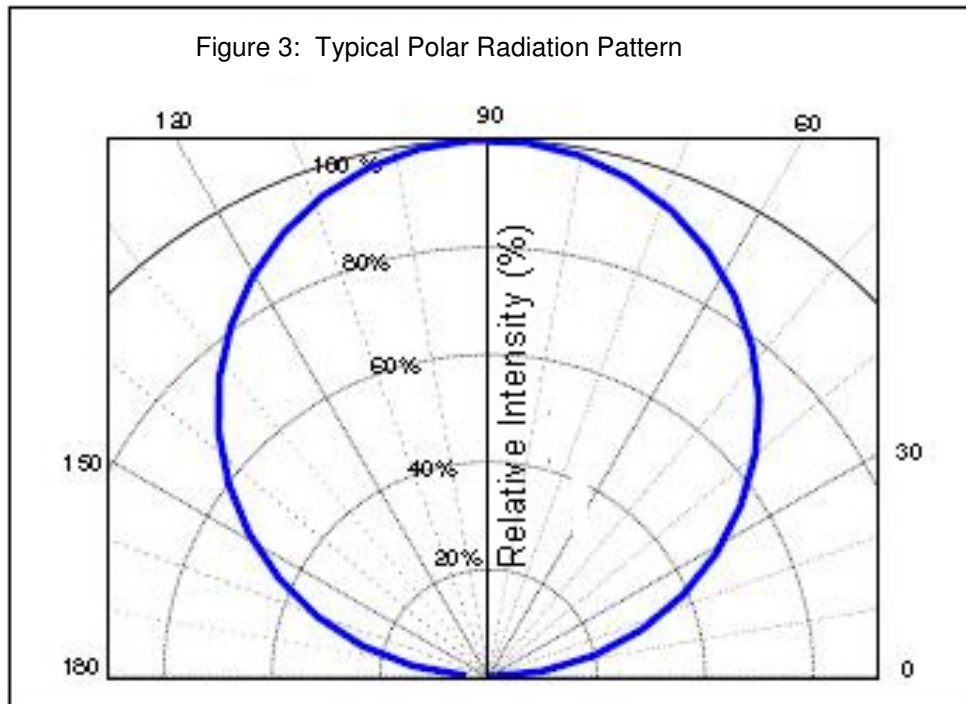
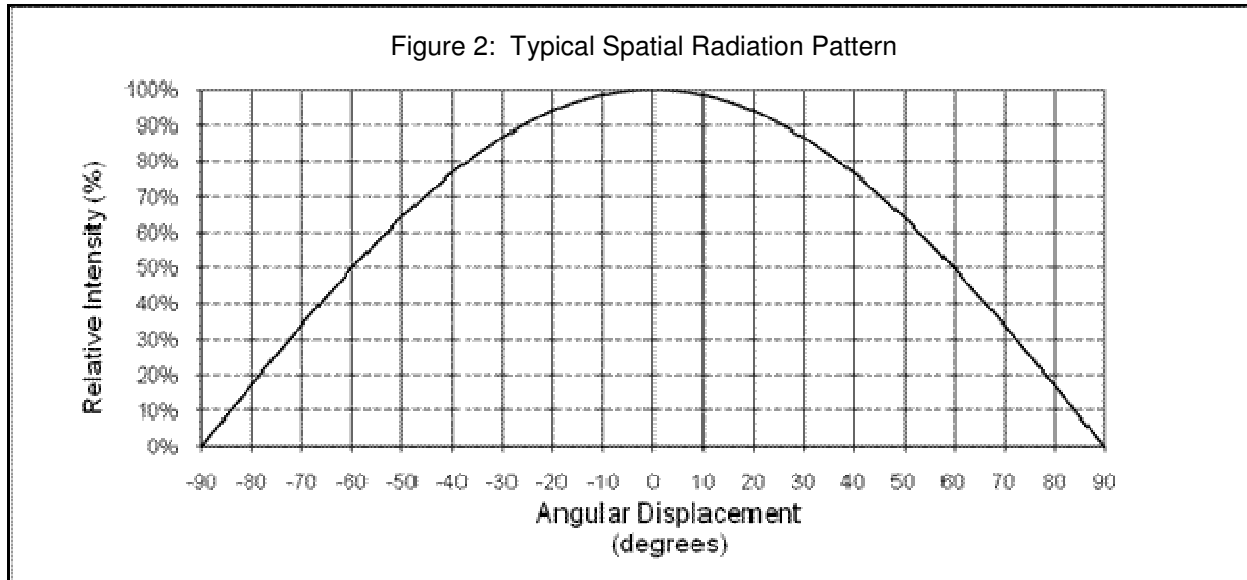

Wavelength Characteristics at Rated Test Current, $T_j=25^\circ\text{C}$

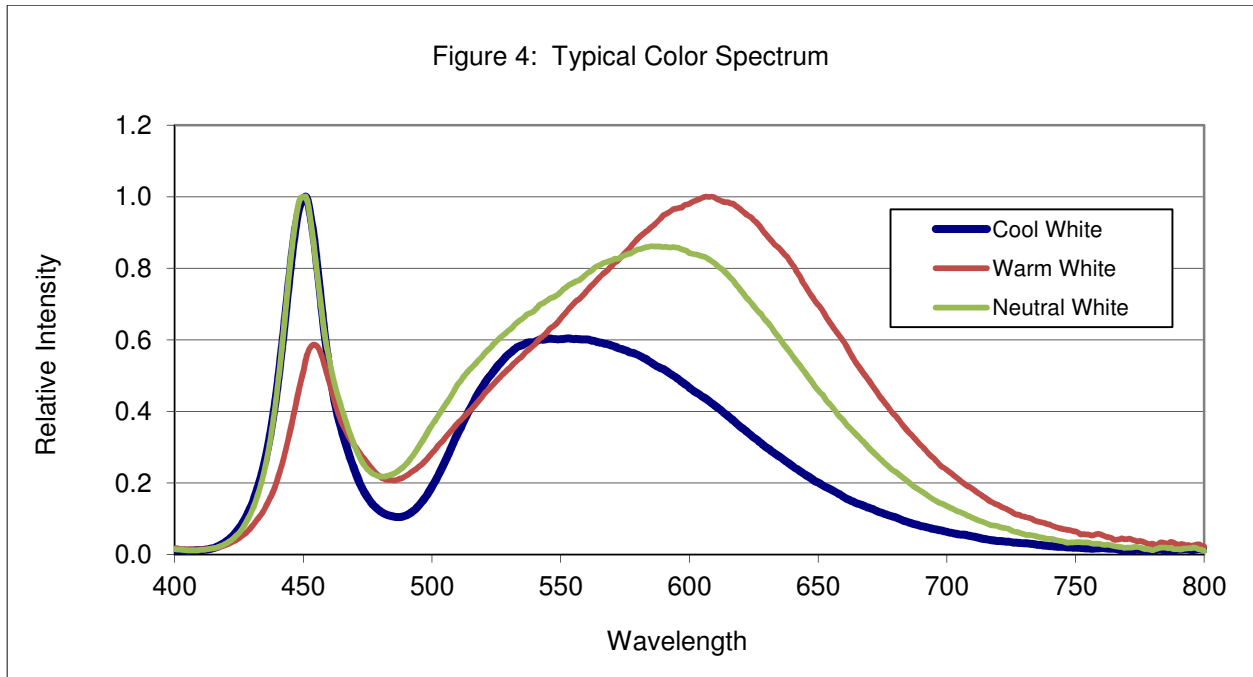

Typical Relative Luminous Flux vs. Current, T_j=25 °C

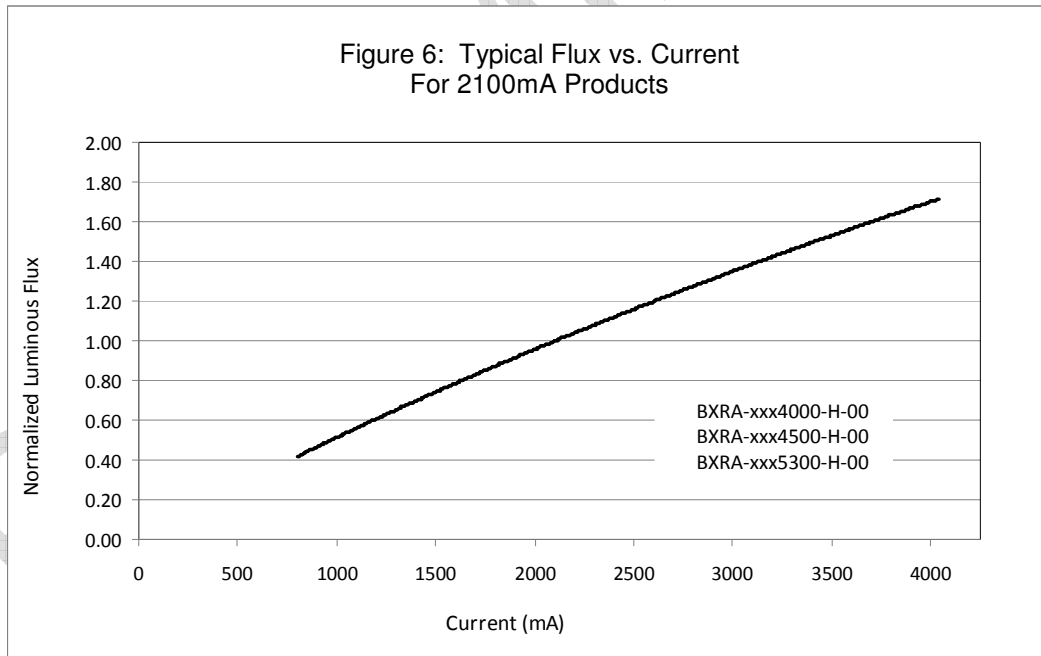
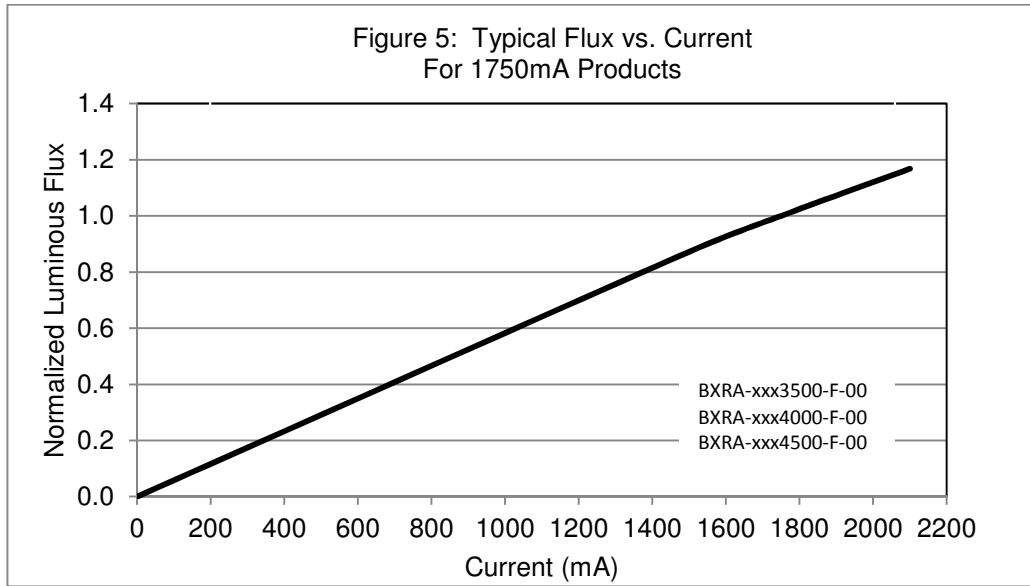

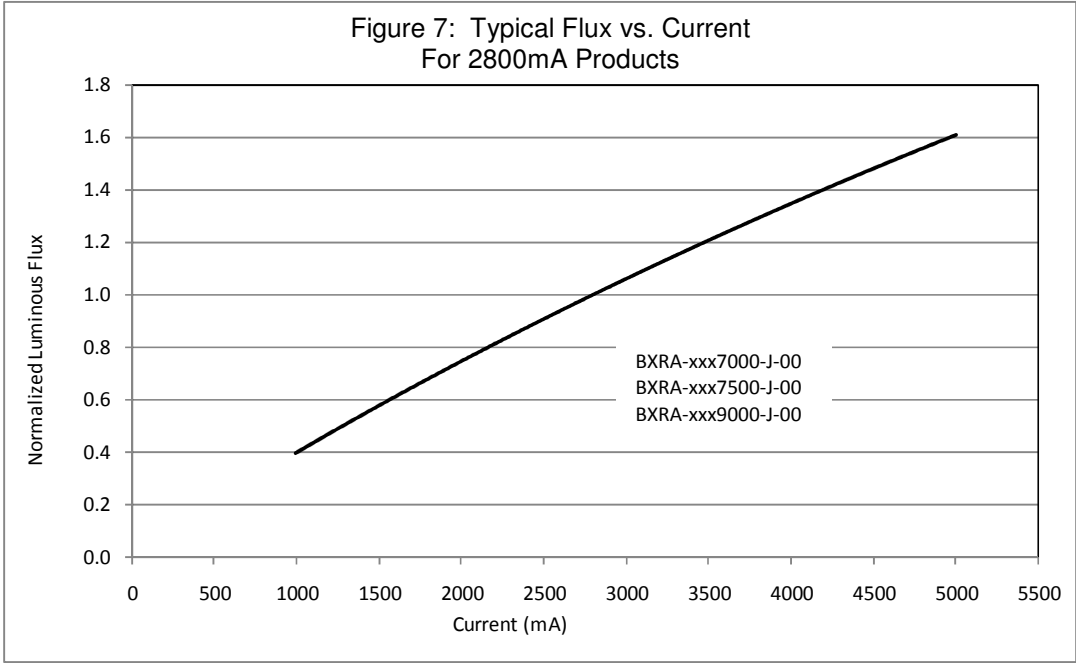

PRELIMINARY

Typical Light Output Characteristics vs. Temperature

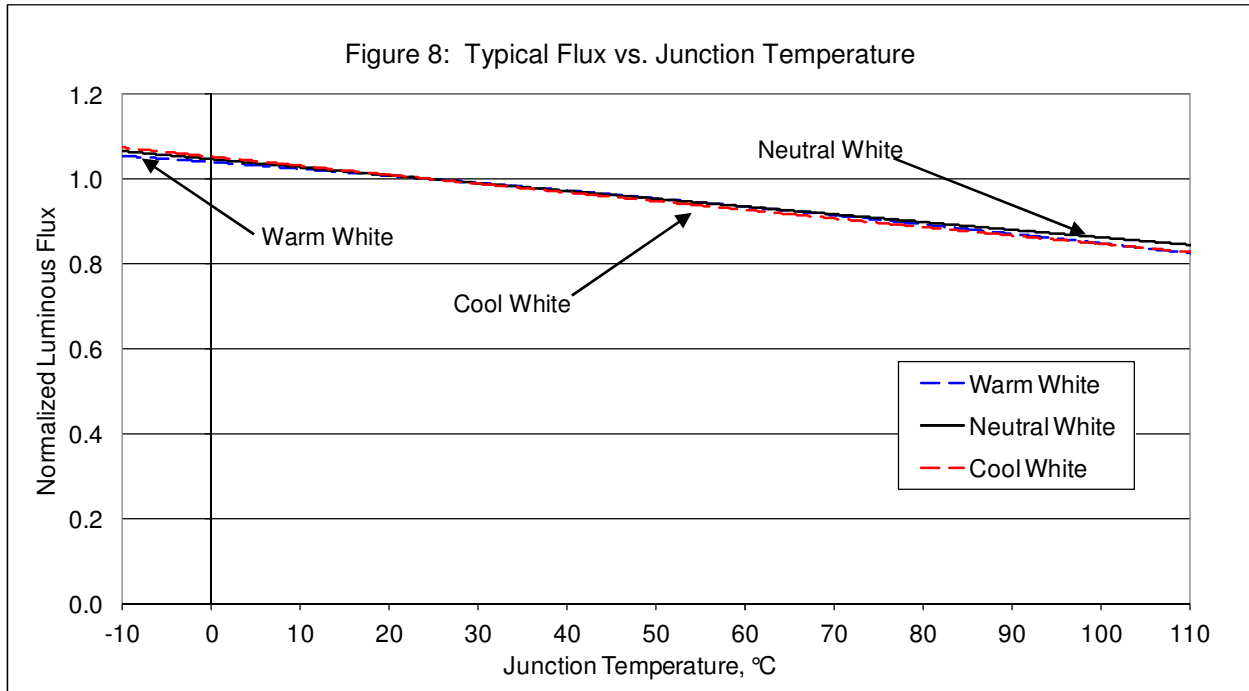

Typical Chromaticity Characteristics vs. Temperature

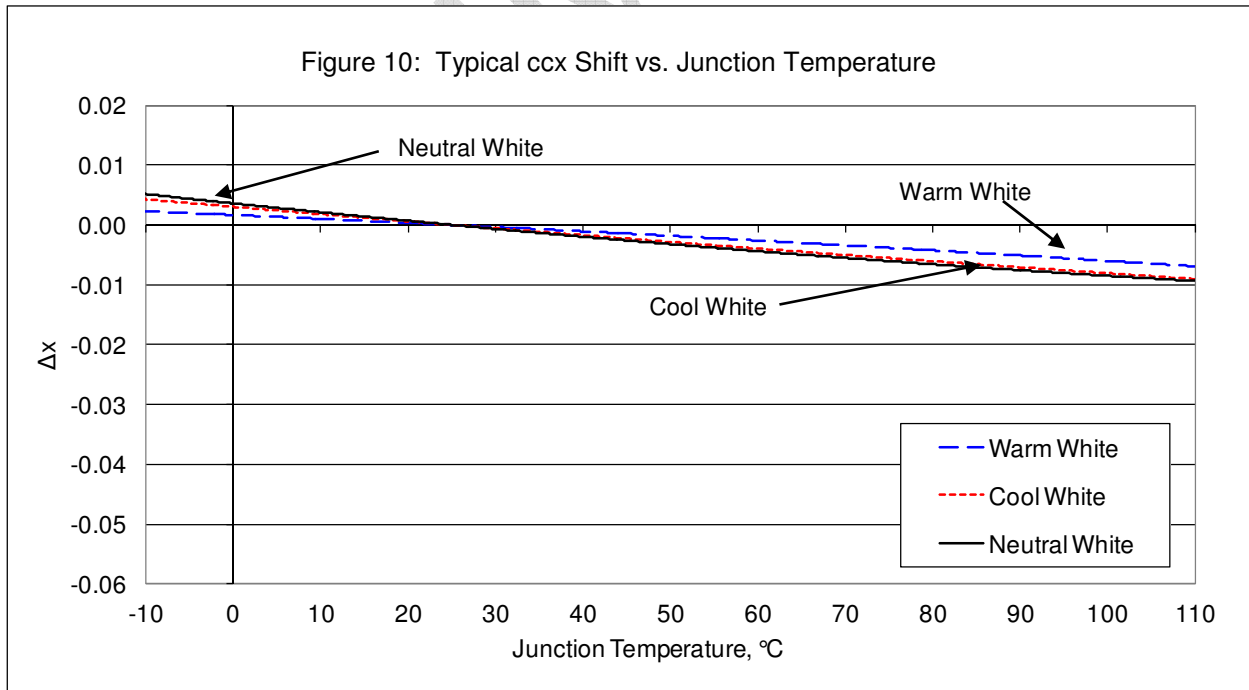
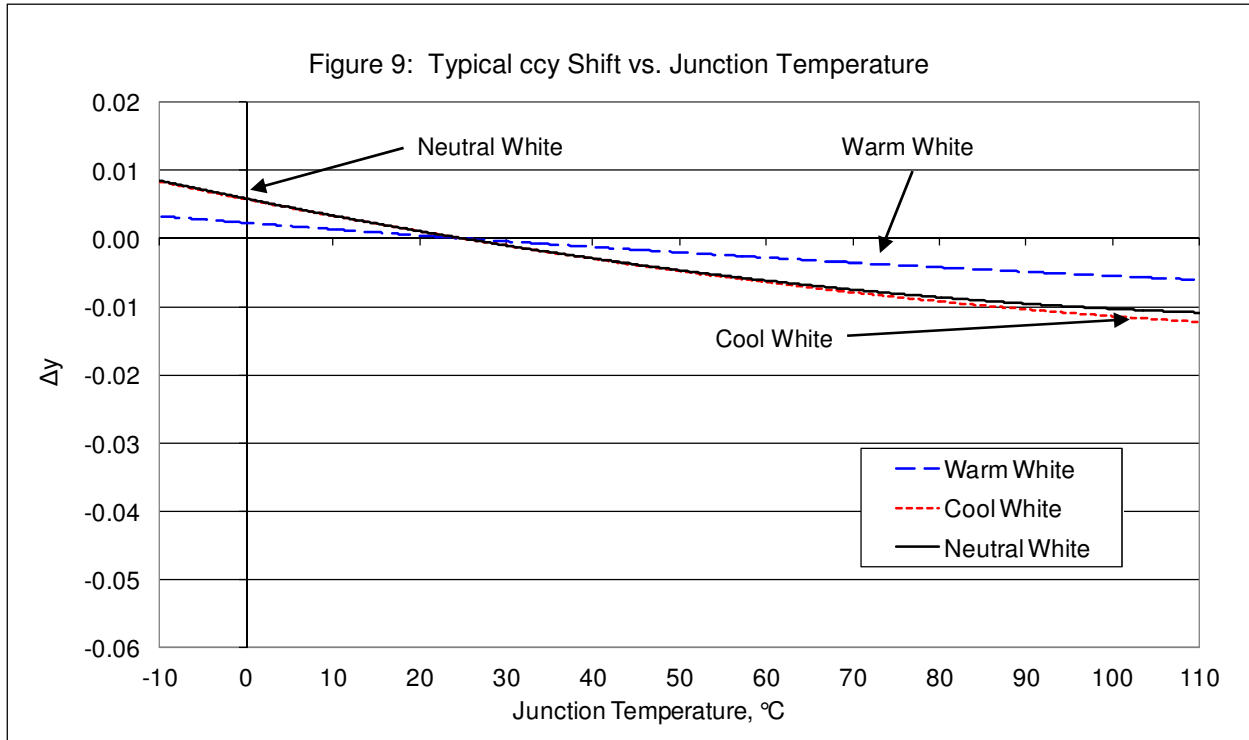

Forward Current Characteristics

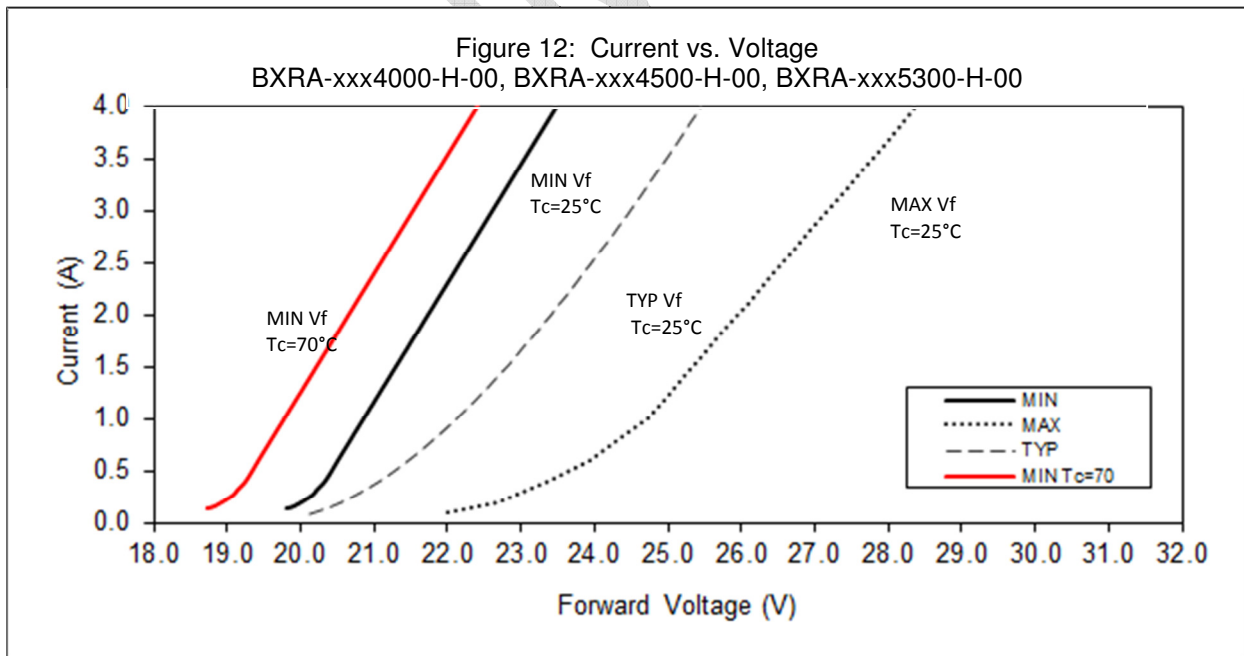
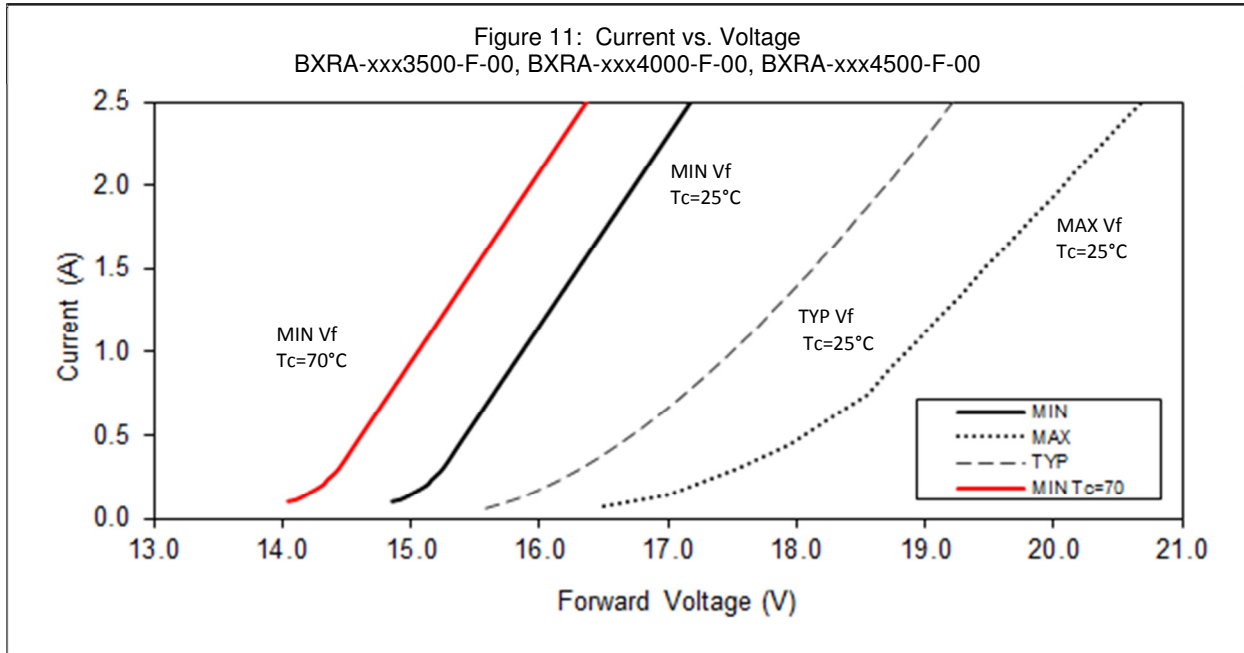

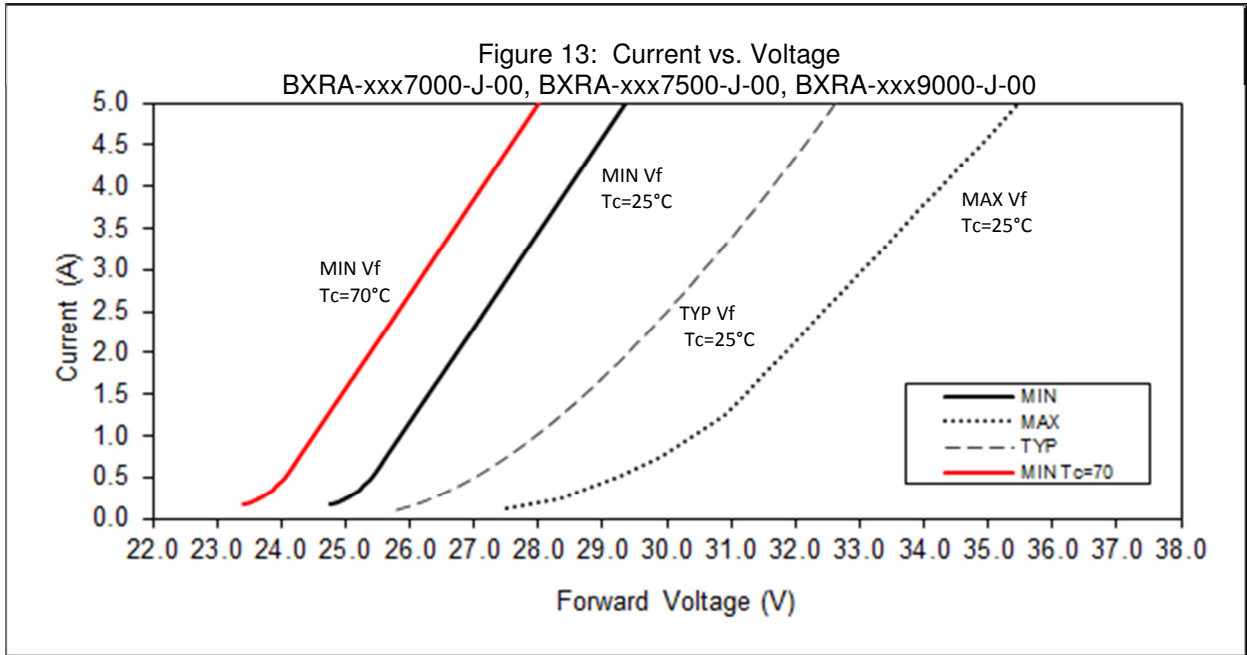

PRELIMINARY

Color Binning Information

Figure 14: Graph of Warm White Test Bins in xy Color Space

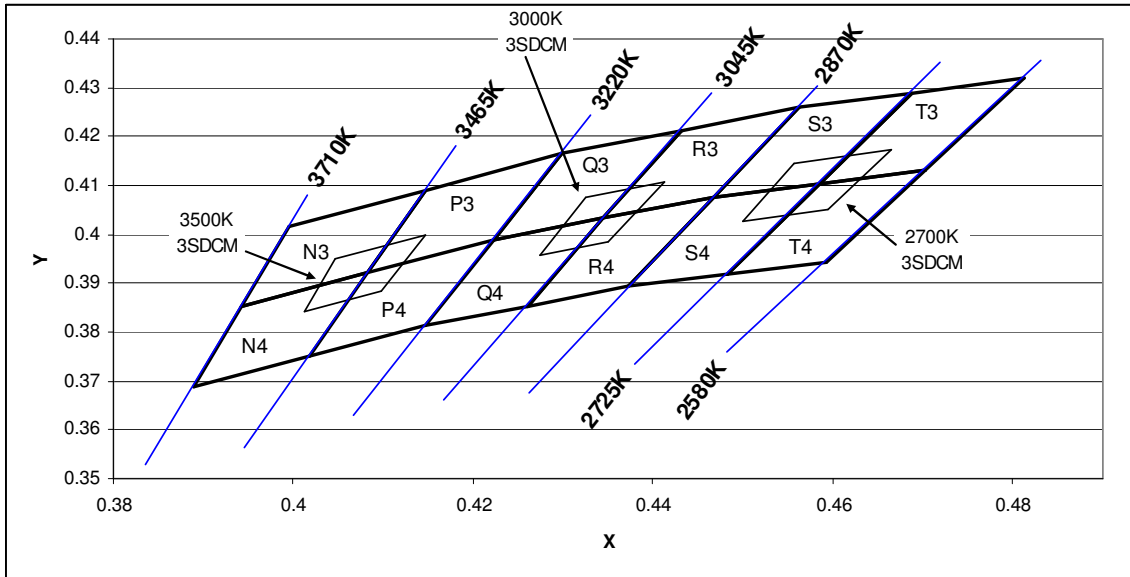

Table 10: Warm White xy Bin Coordinates and Associated Typical CCT

Bin Code	X	Y	ANSI CCT (K)	Bin Code	X	Y	ANSI CCT (K)	Bin Code	X	Y	ANSI CCT (K)
Q3	0.4223	0.3990	3000	S3	0.4468	0.4077	2700	N4	0.3943	0.3853	3500
	0.4299	0.4165			0.4562	0.4260			0.3996	0.4015	
	0.4431	0.4213			0.4688	0.4290			0.4148	0.4090	
	0.4345	0.4033			0.4585	0.4104			0.4083	0.3921	
Q4	0.4147	0.3814	3000	S4	0.4373	0.3893	2700	N3	0.3889	0.3690	3500
	0.4223	0.3990			0.4468	0.4077			0.3943	0.3853	
	0.4345	0.4033			0.4585	0.4104			0.4083	0.3921	
	0.4260	0.3854			0.4483	0.3919			0.4018	0.3752	
R3	0.4345	0.4033	3000	T4	0.4585	0.4104	2700	P3	0.4083	0.3921	3500
	0.4431	0.4213			0.4688	0.4290			0.4148	0.4090	
	0.4562	0.4260			0.4813	0.4319			0.4299	0.4165	
	0.4468	0.4077			0.4703	0.4132			0.4223	0.3990	
R4	0.4260	0.3854	3000	T3	0.4483	0.3919	2700	P4	0.4018	0.3752	3500
	0.4345	0.4033			0.4585	0.4104			0.4083	0.3921	
	0.4468	0.4077			0.4703	0.4132			0.4223	0.3990	
	0.4373	0.3893			0.4593	0.3944			0.4147	0.3814	
X3 (3SDCM)	0.4413	0.4107	3000	X3 (3SDCM)	0.4656	0.4174	2700	X3 (3SDCM)	0.4148	0.4000	3500
	0.4325	0.4075			0.4573	0.4154			0.4047	0.3950	
	0.4274	0.3958			0.4510	0.4032			0.4012	0.3841	
	0.4350	0.3984			0.4583	0.4049			0.4098	0.3883	

Color Binning Information (continued)

Figure 15: Graph of Neutral White Test Bins in xy Color Space

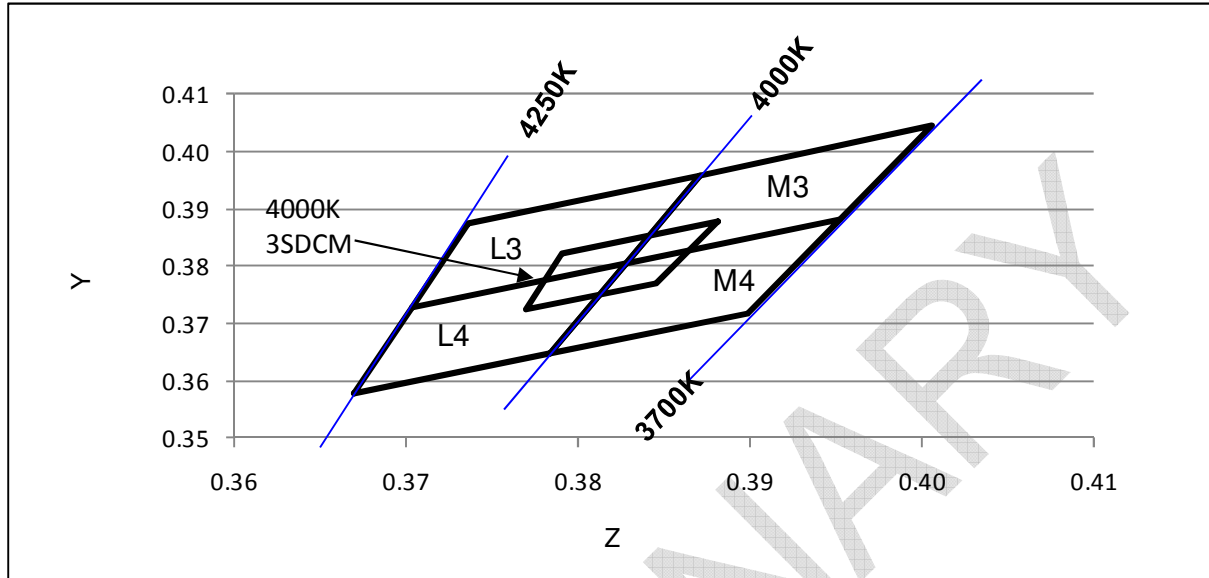

Table 11: Neutral White xy Bin Coordinates and Associated Typical CCT

Bin Code	X	Y	ANSI CCT (K)
L3	0.3703	0.3726	4000
	0.3736	0.3874	
	0.3871	0.3959	
	0.3828	0.3803	
L4	0.3670	0.3578	4000
	0.3703	0.3726	
	0.3828	0.3803	
	0.3784	0.3647	
M3	0.3828	0.3803	4000
	0.3871	0.3959	
	0.4006	0.4044	
	0.3952	0.3880	
M4	0.3784	0.3647	4000
	0.3828	0.3803	
	0.3952	0.3880	
	0.3898	0.3716	
X3 (3SDCM)	0.3881	0.3879	4000
	0.3791	0.3823	
	0.3769	0.3724	
	0.3845	0.3770	

Color Binning Information (continued)

Figure 16: Graph of Cool White Test Bins in xy Color Space

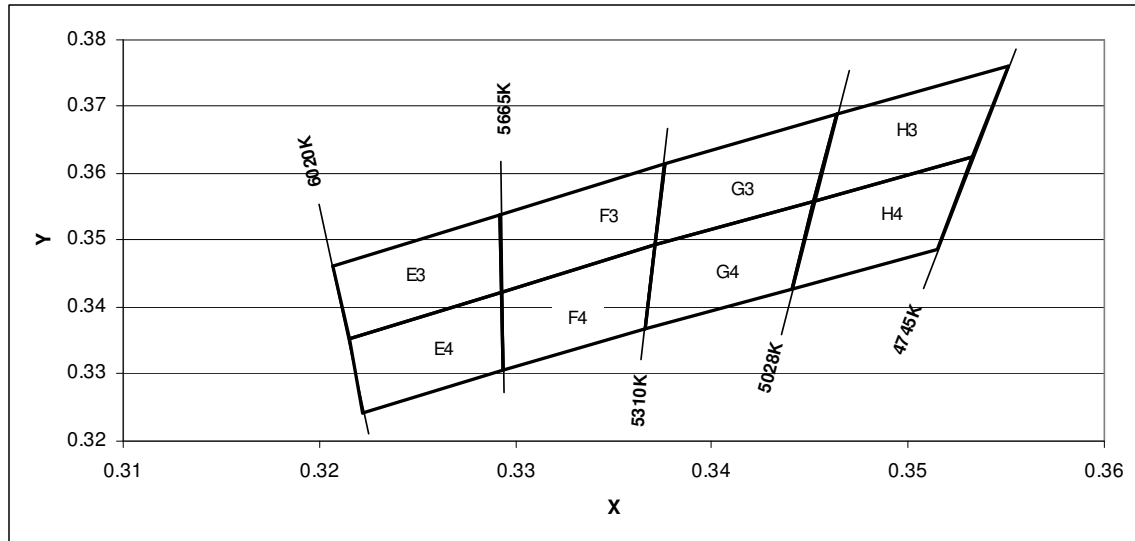

Table 12: Cool White xy Bin Coordinates and Associated Typical CCT

Bin Code	X	Y	ANSI CCT (K)	Bin Code	X	Y	ANSI CCT (K)
G3	0.3376	0.3616	5000	E3	0.3215	0.3353	5600
	0.3464	0.3688			0.3293	0.3423	
	0.3452	0.3558			0.3292	0.3539	
	0.3371	0.3493			0.3207	0.3462	
G4	0.3371	0.3493	5000	E4	0.3222	0.3243	5600
	0.3452	0.3558			0.3294	0.3306	
	0.3441	0.3428			0.3293	0.3423	
	0.3366	0.3369			0.3215	0.3353	
H3	0.3464	0.3688	5000	F3	0.3292	0.3539	5600
	0.3551	0.376			0.3293	0.3423	
	0.3533	0.3624			0.3371	0.3493	
	0.3452	0.3558			0.3376	0.3616	
H4	0.3452	0.3558	5000	F4	0.3294	0.3306	5600
	0.3533	0.3624			0.3366	0.3369	
	0.3515	0.3487			0.3371	0.3493	
	0.3441	0.3428			0.3293	0.3423	

Design Resources

Bridgelux has developed a comprehensive set of application notes and design resources to assist customers in successfully designing with Bridgelux LED Array products. Included below is a list of available resources which can be downloaded from the Bridgelux web site under the Design Resources section. These documents are updated regularly as new information becomes available, including complimentary infrastructure products such as commercially available secondary optics and electronic driver solutions.

Application Notes

- AN10: Effective Thermal Management of Bridgelux LED Arrays
- AN11: Assembly Considerations for Bridgelux LED Arrays
- AN12: Electrical Drive Considerations for Bridgelux LED Arrays
- AN14: Reliability Data Sheet for Bridgelux LED Arrays
- AN15: Reflow Soldering of Bridgelux LED Arrays
- AN16: Optical Considerations for Bridgelux LED Arrays

Optical Source Models

Optical source models and ray set files are available for all Bridgelux LED Array products, and can be downloaded directly from the Bridgelux web site. The list below contains the formats currently available. If you require a specific format not included in this list, please contact your Bridgelux sales representative for assistance.

- Zemax
- ASAP
- IESNA
- LightTools
- LucidShape
- OPTIS SPEOS
- PHOTOPIA
- TracePro
- Radiant Imaging Source Model

3D CAD Models

Three dimensional CAD models depicting the product outline of all Bridgelux LED Arrays are available in both SAT and STEP formats. These CAD files can be downloaded directly from the Bridgelux web site.

About Bridgelux

Bridgelux is a leading developer and manufacturer of technologies and solutions transforming the \$40 billion global lighting industry into a \$100 billion market opportunity. Based in Livermore, California, Bridgelux is a pioneer in solid-state lighting (SSL), expanding the market for light-emitting diode (LED) technologies by driving down the cost of LED lighting systems. Bridgelux's patented light source technology replaces traditional technologies (such as incandescent, halogen, fluorescent and high intensity discharge lighting) with integrated, solid-state lighting solutions that enable lamp and luminaire manufacturers to provide high performance and energy-efficient white light for the rapidly growing interior and exterior lighting markets, including street lights, commercial lighting and consumer applications. With more than 650 patent applications filed or granted worldwide, Bridgelux is the only vertically integrated LED manufacturer and developer of solid-state light sources that designs its solutions specifically for the lighting industry.

For more information about the company, please visit www.bridgelux.com

© 2012 Bridgelux, Inc. All rights reserved. Product specifications are subject to change without notice.

