

- Rugged Triple-Diffused Planar Construction
- 6 A Continuous Collector Current
- Operating Characteristics Fully Guaranteed at 100°C
- 1000 Volt Blocking Capability
- 120 W at 25°C Case Temperature

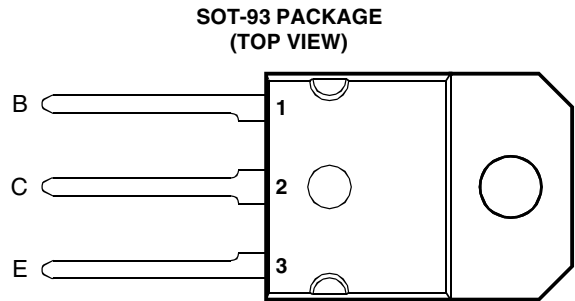

Pin 2 is in electrical contact with the mounting base.

MDTRAAA

absolute maximum ratings at 25°C case temperature (unless otherwise noted)

RATING		SYMBOL	VALUE	UNIT
Collector-base voltage ($I_E = 0$)	TIPL762	V_{CBO}	850	V
	TIPL762A		1000	
Collector-emitter voltage ($V_{BE} = 0$)	TIPL762	V_{CES}	850	V
	TIPL762A		1000	
Collector-emitter voltage ($I_B = 0$)	TIPL762	V_{CEO}	400	V
	TIPL762A		450	
Emitter-base voltage		V_{EBO}	10	V
Continuous collector current		I_C	6	A
Peak collector current (see Note 1)		I_{CM}	12	A
Continuous device dissipation at (or below) 25°C case temperature		P_{tot}	120	W
Operating junction temperature range		T_j	-65 to +150	°C
Storage temperature range		T_{stg}	-65 to +150	°C

NOTE 1: This value applies for $t_p \leq 10$ ms, duty cycle $\leq 2\%$.

PRODUCT INFORMATION

electrical characteristics at 25°C case temperature (unless otherwise noted)

PARAMETER	TEST CONDITIONS			MIN	TYP	MAX	UNIT
$V_{CE(sus)}$ Collector-emitter sustaining voltage	$I_C = 100 \text{ mA}$	$L = 25 \text{ mH}$	(see Note 2)	TIPL762 TIPL762A	400 450		V
I_{CES} Collector-emitter cut-off current	$V_{CE} = 850 \text{ V}$	$V_{BE} = 0$		TIPL762		50	μA
	$V_{CE} = 1000 \text{ V}$	$V_{BE} = 0$		TIPL762A		50	
	$V_{CE} = 850 \text{ V}$	$V_{BE} = 0$	$T_C = 100^\circ\text{C}$	TIPL762		200	
	$V_{CE} = 1000 \text{ V}$	$V_{BE} = 0$	$T_C = 100^\circ\text{C}$	TIPL762A		200	
I_{CEO} Collector cut-off current	$V_{CE} = 400 \text{ V}$	$I_B = 0$		TIPL762		50	μA
	$V_{CE} = 450 \text{ V}$	$I_B = 0$		TIPL762A		50	
I_{EBO} Emitter cut-off current	$V_{EB} = 10 \text{ V}$	$I_C = 0$				1	mA
h_{FE} Forward current transfer ratio	$V_{CE} = 5 \text{ V}$	$I_C = 0.5 \text{ A}$	(see Notes 3 and 4)		20	60	
$V_{CE(sat)}$ Collector-emitter saturation voltage	$I_B = 0.4 \text{ A}$	$I_C = 2 \text{ A}$				0.5	V
	$I_B = 0.8 \text{ A}$	$I_C = 4 \text{ A}$	(see Notes 3 and 4)			1.0	
	$I_B = 1.2 \text{ A}$	$I_C = 6 \text{ A}$				2.5	
	$I_B = 1.2 \text{ A}$	$I_C = 6 \text{ A}$	$T_C = 100^\circ\text{C}$			5.0	
$V_{BE(sat)}$ Base-emitter saturation voltage	$I_B = 0.4 \text{ A}$	$I_C = 2 \text{ A}$				1.1	V
	$I_B = 0.8 \text{ A}$	$I_C = 4 \text{ A}$	(see Notes 3 and 4)			1.3	
	$I_B = 1.2 \text{ A}$	$I_C = 6 \text{ A}$				1.5	
	$I_B = 1.2 \text{ A}$	$I_C = 6 \text{ A}$	$T_C = 100^\circ\text{C}$			1.4	
f_t Current gain bandwidth product	$V_{CE} = 10 \text{ V}$	$I_C = 0.5 \text{ A}$	$f = 1 \text{ MHz}$		6		MHz
C_{ob} Output capacitance	$V_{CB} = 20 \text{ V}$	$I_E = 0$	$f = 0.1 \text{ MHz}$		105		pF

- NOTES: 2. Inductive loop switching measurement.
 3. These parameters must be measured using pulse techniques, $t_p = 300 \mu\text{s}$, duty cycle $\leq 2\%$.
 4. These parameters must be measured using voltage-sensing contacts, separate from the current carrying contacts.

thermal characteristics

PARAMETER	MIN	TYP	MAX	UNIT
$R_{\theta JC}$ Junction to case thermal resistance			1.25	$^\circ\text{C/W}$

inductive-load-switching characteristics at 25°C case temperature (unless otherwise noted)

PARAMETER	TEST CONDITIONS †			MIN	TYP	MAX	UNIT
t_{sv} Voltage storage time	$I_C = 6 \text{ A}$ $V_{BE(off)} = -10 \text{ V}$	$I_{B(on)} = 1.2 \text{ A}$	(see Figures 1 and 2)			2.5	μs
t_{rv} Voltage rise time						200	ns
t_{fi} Current fall time						150	ns
t_{ti} Current tail time						50	ns
t_{xo} Cross over time						300	ns
t_{sv} Voltage storage time	$I_C = 6 \text{ A}$ $V_{BE(off)} = -10 \text{ V}$	$I_{B(on)} = 1.2 \text{ A}$	(see Figures 1 and 2)			3	μs
t_{rv} Voltage rise time						300	ns
t_{fi} Current fall time						150	ns
t_{ti} Current tail time					$T_C = 100^\circ\text{C}$	50	ns
t_{xo} Cross over time						500	ns

† Voltage and current values shown are nominal; exact values vary slightly with transistor parameters.

TYPICAL CHARACTERISTICS

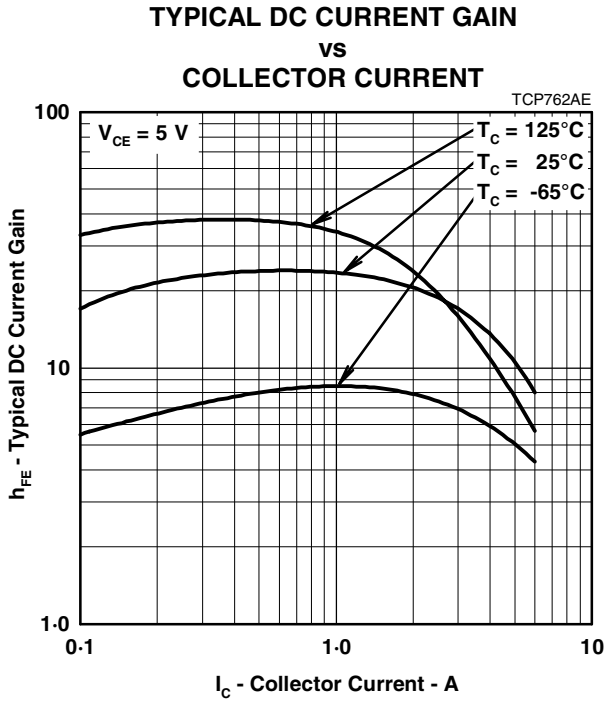

Figure 3.

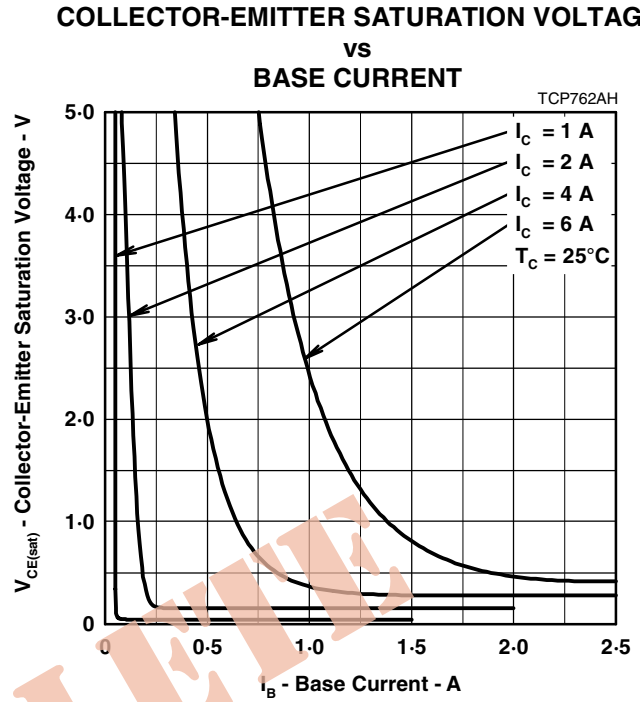

Figure 4.

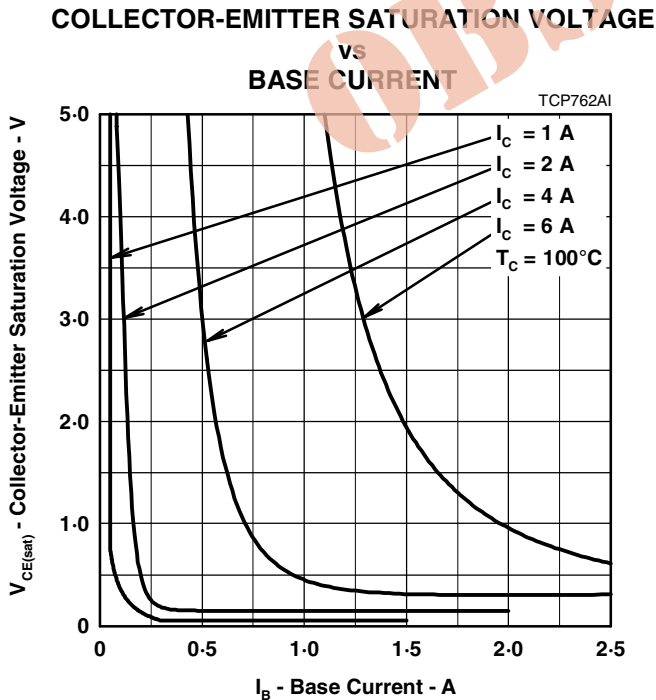

Figure 5.

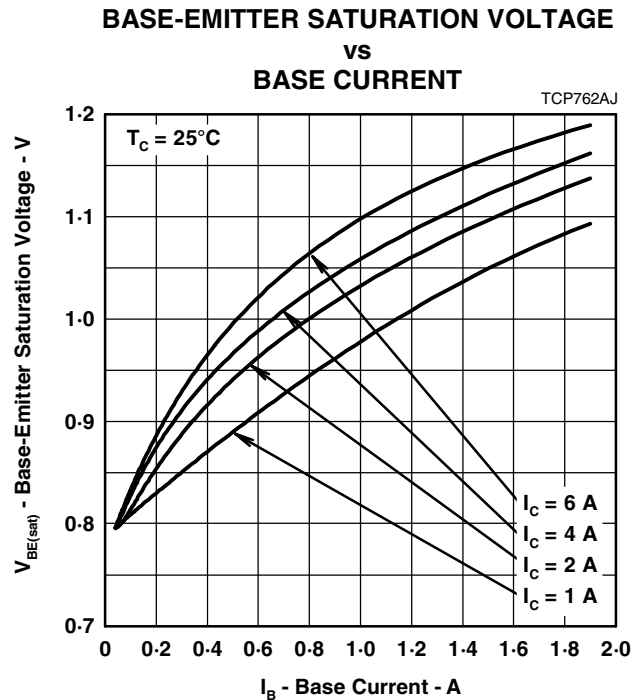

Figure 6.

PRODUCT INFORMATION

AUGUST 1978 - REVISED SEPTEMBER 2002
Specifications are subject to change without notice.

TYPICAL CHARACTERISTICS

**COLLECTOR CUT-OFF CURRENT
vs
CASE TEMPERATURE**

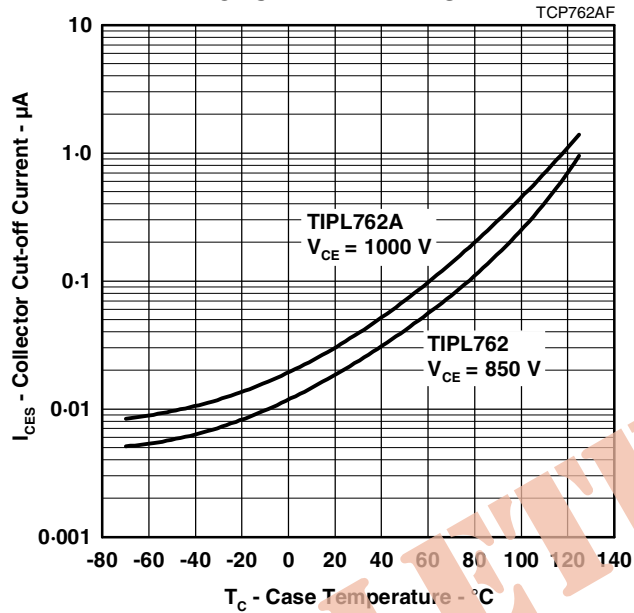

Figure 7.

MAXIMUM SAFE OPERATING REGIONS

**MAXIMUM FORWARD-BIAS
SAFE OPERATING AREA**

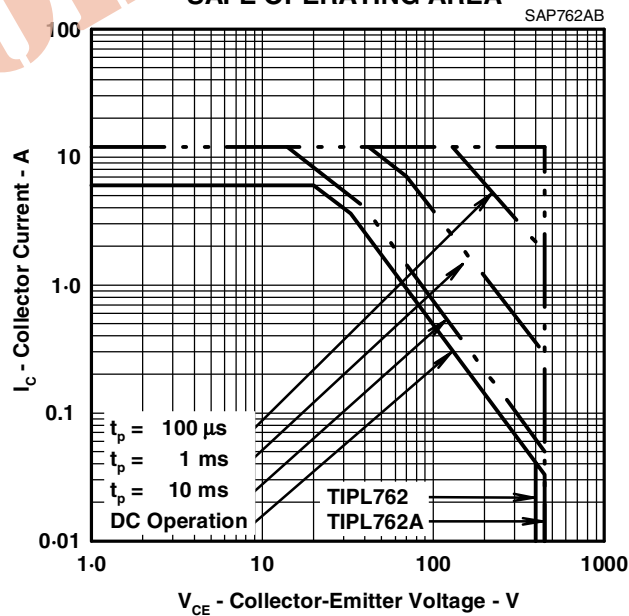

Figure 8.

PRODUCT INFORMATION

AUGUST 1978 - REVISED SEPTEMBER 2002
Specifications are subject to change without notice.

THERMAL INFORMATION

**THERMAL RESPONSE JUNCTION TO CASE
 VS
 POWER PULSE DURATION**

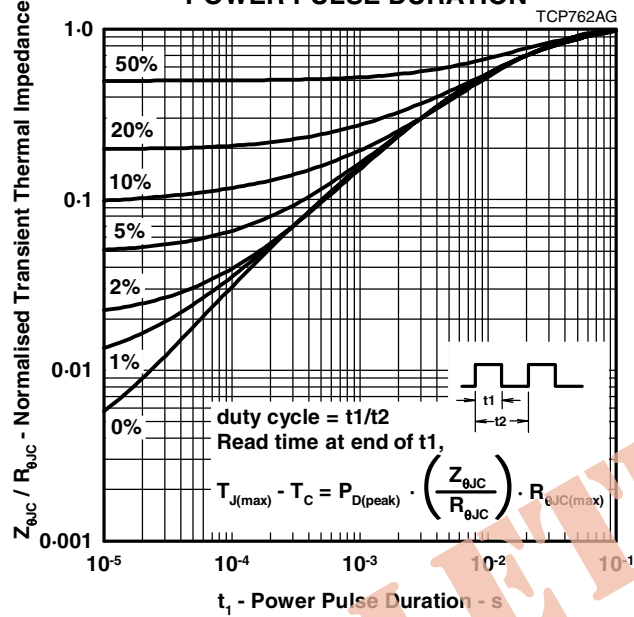

Figure 9.

OBSOLETE