

## Non-ISOLATED DC/DC CONVERTERS

5.0 Vdc Input, 0.8 Vdc - 3.6 Vdc/22 A Output

**bel**  
POWER PRODUCTS

### 0RLB-22B1A0 RoHS Compliant PRELIMINARY Rev.A

- Non-Isolated
- Fixed Frequency
- High Efficiency
- High Power Density
- Wide Trim Range
- Margen Up/Down
- Remote On/Off
- Input Under Voltage Lockout
- SCP/OCP
- Auto-Track Sequencing
- Over Temperature Protection

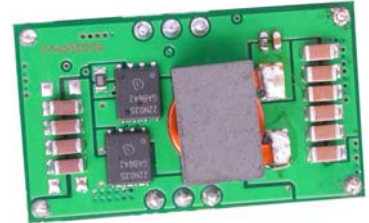

### Description

The Bel 0RLB-22B1A0 modules are a series of non-isolated dc/dc converters that can deliver up to 22 A of output current with full load efficiency of 93% at 3.3 Vdc output. These modules provide precisely regulated voltage programmable via external resistor from 0.8 Vdc to 3.6 Vdc. This modules has a sequencing feature. Their open-frame construction and small footprint enable designers to develop cost and space-efficient solutions. Standard features include remote On/Off, programmable output voltage, over current protection, over-temperature protection, and margin up/down controls.

### Part Selection

Output Voltage	Input Voltage	Max. Output Current	Max. Output Power	Typical Efficiency	Model Number
0.8 Vdc - 3.6 Vdc	4.5 Vdc - 5.5 Vdc	22 A	79 W	95%	0RLB-22B1A0

- Notes:** 1. Add "G" suffix at the end of the model number to indicate Tray Packaging.  
2. All part numbers above indicate RoHS 6. Change the second letter "R" to "7" for RoHS 5 part numbers.

### Absolute Maximum Ratings

Parameter	Min	Typ	Max	Notes
Input Voltage (continuous)	-0.3 V	-	5.5 V	
Remote On/Off (Active High)	-0.3 V	-	Vin+0.3 V	
Ambient Temperature	-40 °C	-	85 °C	
Storage Temperature	-55 °C	-	125 °C	

**Note:** The module includes an Auto-Track sequencing feature. This is accomplished via an additional sequencing pin. When not used sequencing feature, tie the SEQ pin to Vin.

### Input Specifications

Parameter	Min	Typ	Max	Notes
Input Voltage	4.5 V	5.0 V	5.5 V	
Input Current				
Vo=3.3 V	-	-	18 A	
Vo=2.5 V	-	-	14 A	
Vo=1.8 V	-	-	11 A	
Vo=1.5 V	-	-	9 A	
Vo=1.2 V	-	-	8 A	
Vo=1.0 V	-	-	7 A	
Input Current (no load)	-	65 mA	80 mA	
Remote Off Input Current	-	8 mA	15 mA	

## Non-ISOLATED DC/DC CONVERTERS

5.0 Vdc Input, 0.8 Vdc - 3.6 Vdc/22 A Output



### Input Specifications

Parameter	Min	Typ	Max	Notes
Input Reflected Ripple Current (rms)	-	60 mA	100 mA	With simulated source impedance of 1uH, 5Hz to 20MHz and a 1000uF/16V external input electrolytic caps.
Input Reflected Ripple Current (pk-pk)	-	200 mA	300 mA	
I <sup>2</sup> t Inrush Current Transient	-	-	0.01 A <sup>2</sup> s	
Turn-on Input Voltage	4.1 V	4.3 V	4.5 V	
Turn-off Input Voltage	3.1 V	3.7 V	4.2 V	

**Note:** All specifications are typical at 25 °C unless otherwise stated.

### Output Specifications

Parameter	Min	Typ	Max	Notes
Output Voltage Set Point Accuracy	-2%Vo, set	-	2%Vo, set	Vin=5 V, Io=Iomax
Output Voltage Set Point	-3%Vo, set	-	3%Vo, set	Over all operating input voltage, resistive load, and temperature conditions
Line Regulation	-0.3%Vo, set	-	0.3%Vo, set	
Load Regulation	-0.3%Vo, set	-	0.3%Vo, set	
Temperature Regulation (-40 °C to +85 °C)	-1%Vo, set	-	1%Vo, set	
Ripple and Noise (rms)	-	10 mV	20 mV	0-20 MHz BW, with external 10 uF/10 V Tan cap, 1uF/10 V TDK ceramic cap at the output.
Ripple and Noise (pk-pk)	-	25 mV	40 mV	
Output Current	0 A	-	22 A	
Current Limit Threshold	25 A	32 A	40 A	
Short Circuit Surge Transient	-	-	1 A <sup>2</sup> s	
Turn on Time	-	6 mS	10 mS	
Overshoot at Turn On	-	0%	3%	
Output Capacitance Ceramic Non-ceramic	0 uF 0 uF	- -	300 uF 11000 uF	External load capacitance is the calculated maximum. The minimum ESR limitation will often result in a lower value.

#### Transient Response

50% ~ 100% Max Load	Overshoot	Vo=All	-	120 mV	200 mV	di/dt=1 A/us, Vin=5 Vdc, Ta=25°C, and with 330 uF/6.3 V Tan Cap and 1uF/10 V ceramic cap at the output.
	Settling Time		-	20 uS	50 uS	
100% ~ 50% Max Load	Overshoot		-	120 mV	200 mV	
	Settling Time		-	20 uS	50 uS	

**Note:** All specifications are typical at nominal input, full load at 25°C unless noted.

## Non-ISOLATED DC/DC CONVERTERS

5.0 Vdc Input, 0.8 Vdc - 3.6 Vdc/22 A Output



### General Specifications

Parameter	Min	Typ	Max	Notes	
Efficiency				Measured at $V_{in}=5\text{ V}$ , $I_o=14\text{ A}$	
	$V_o=3.3\text{ V}$	92%	95%		-
	$V_o=2.5\text{ V}$	91%	94%		-
	$V_o=1.8\text{ V}$	88%	91%		-
	$V_o=1.5\text{ V}$	87%	90%		-
	$V_o=1.2\text{ V}$	85%	88%		-
$V_o=1.0\text{ V}$	83%	86%	-		
Switching Frequency	275 kHz	300 kHz	325 kHz		
Margin Up/Down Adjust	-5% $V_o$ , set	-	5% $V_o$ , set		
Output Voltage Trim Range	0.8 V	-	3.6 V		
Over Temperature Shutdown	-	125 °C	-		
MTBF	TBD			Calculated Per Bell Core SR-332 ( $I_o = 80\%$ $I_o$ max; $T_a = 25\text{ °C}$ )	
Dimensions					
	Inches (L x W x H)	1.495 x 0.87 x 0.354			
	Millimeters (L x W x H)	37.97 x 22.1 x 8.99			
Weight	-	7 g	-		

**Note:** All specifications are typical at 25 °C unless otherwise stated.

### Control Specifications

Parameter	Min	Typ	Max	Notes
<b>Remote On/Off</b>				
Signal Low (Unit Off)	-0.2 V	-	0.8 V	The remote On/Off pin open, Unit On.
Signal High (Unit On)	1.5 V	-	$V_{in}-0.5\text{ V}$	
<b>Voltage Sequencing</b>				
Sequencing Voltage	-0.3 V	-	$V_{in}+0.3\text{ V}$	
Sequencing Slew Rate Capability	-	-	1 V/msec	
Sequencing Delay time	20 msec	-	-	Delay from $V_{in,min}$ to application of voltage on SEQ pin
Tracking Accuracy				
	Power-Up	-	100 mV	200 mV
	Power-Down	-	200 mV	400 mV

# Non-ISOLATED DC/DC CONVERTERS

5.0 Vdc Input, 0.8 Vdc - 3.6 Vdc/22 A Output



## Output Trim Equations

Equations for calculating the trim resistor (in kΩ) is shown below. Rtrim is the required resistance between TRIM and GND, Vadj\_up is the desired output voltage.

$$R_{trimup}(V_{adj\_up}) := \left( \frac{8}{V_{adj\_up} - 0.8} - 2.49 \right)$$

Vadj_up (V)	Rtrim (KΩ)
0.8	Open
1	36.5
1.2	17.4
1.5	8.87
1.8	5.49
2.5	2.21
3.3	0.698

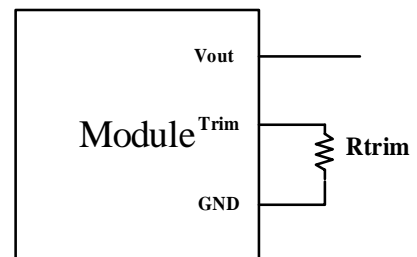

## Auto-Track Sequencing

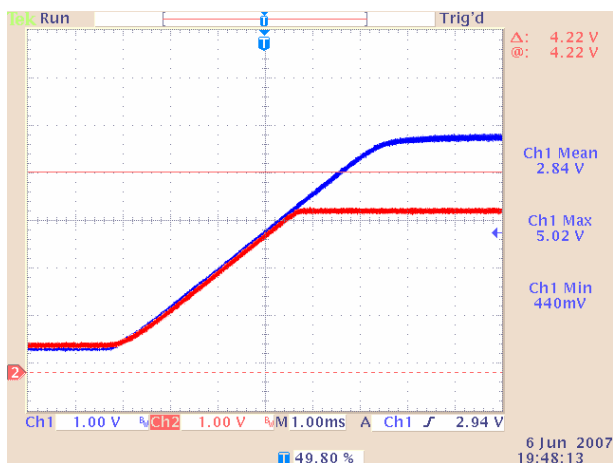

5 Vdc input, 3.3 Vdc output

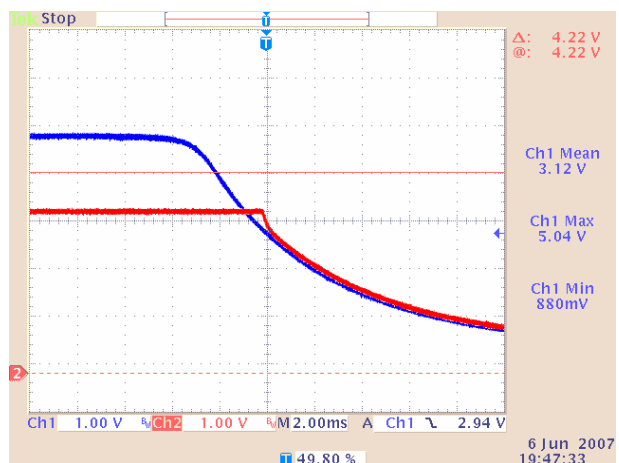

5 Vdc input, 3.3 Vdc output

# Non-ISOLATED DC/DC CONVERTERS

5.0 Vdc Input, 0.8 Vdc - 3.6 Vdc/22 A Output



## Efficiency Data

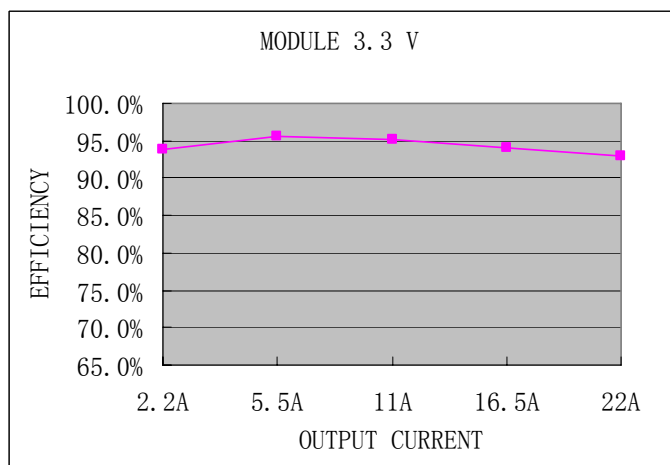
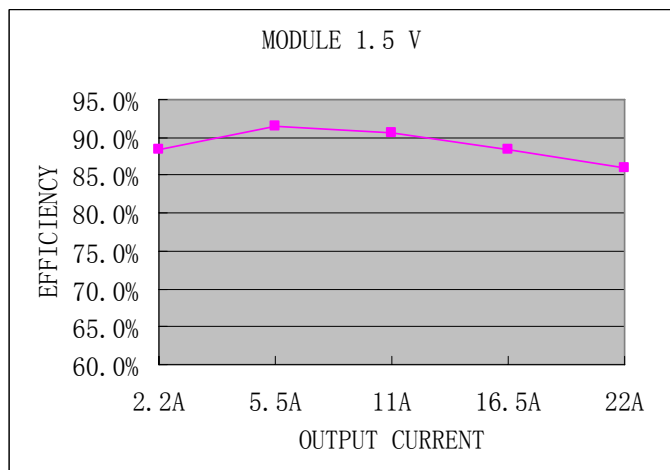
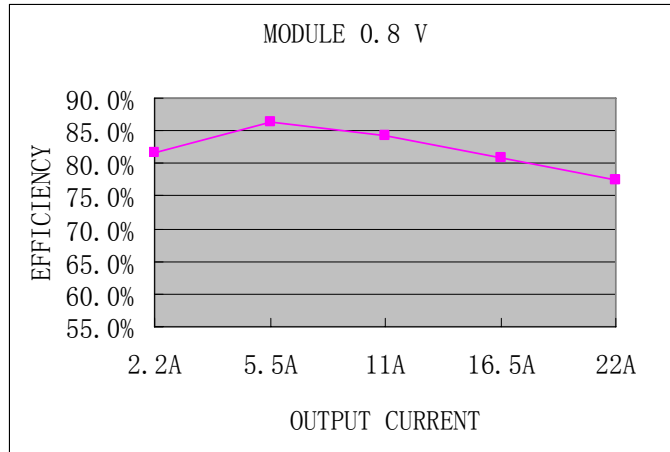

# Non-ISOLATED DC/DC CONVERTERS

5.0 Vdc Input, 0.8 Vdc - 3.6 Vdc/22 A Output



## Thermal Derating Curves

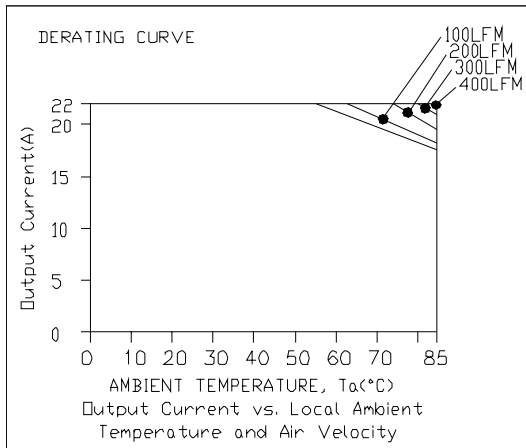

$V_o=0.8\text{ V}$

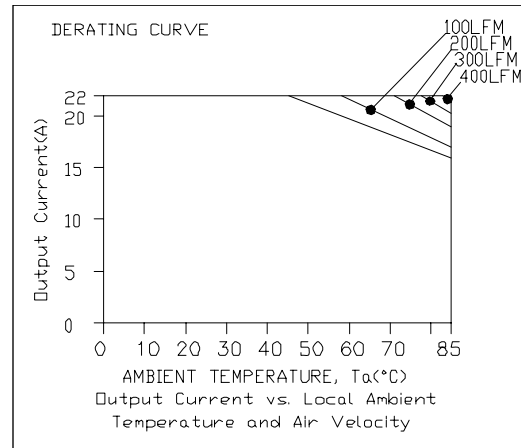

$V_o=1.5\text{ V}$

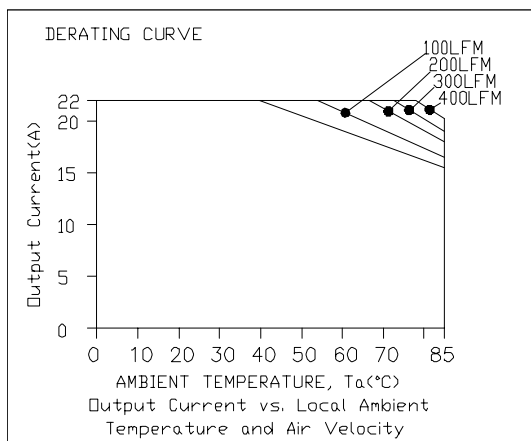

$V_o=2.5\text{ V}$

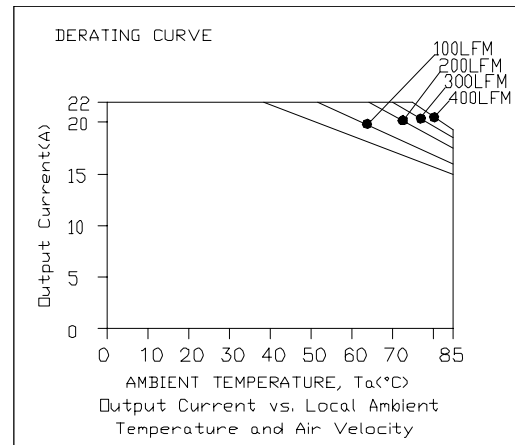

$V_o=3.3\text{ V}$

# Non-ISOLATED DC/DC CONVERTERS

5.0 Vdc Input, 0.8 Vdc - 3.6 Vdc/22 A Output



## Ripple and Noise Waveform

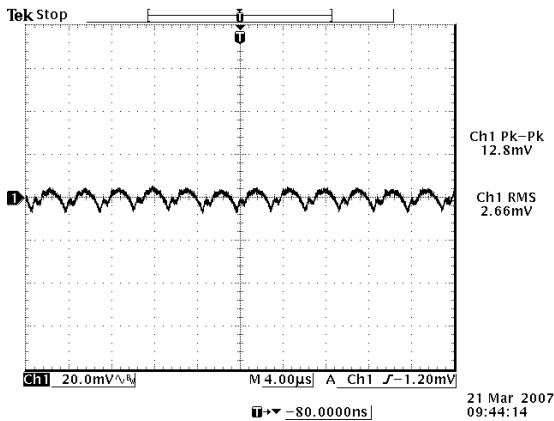

Ripple and noise at no load, 0.8 V output

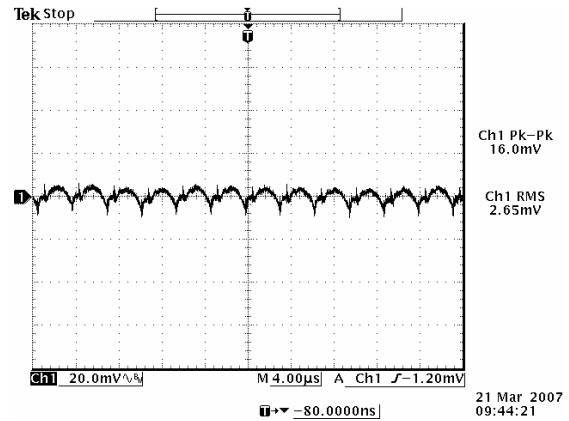

Ripple and noise at full load, 0.8 V output

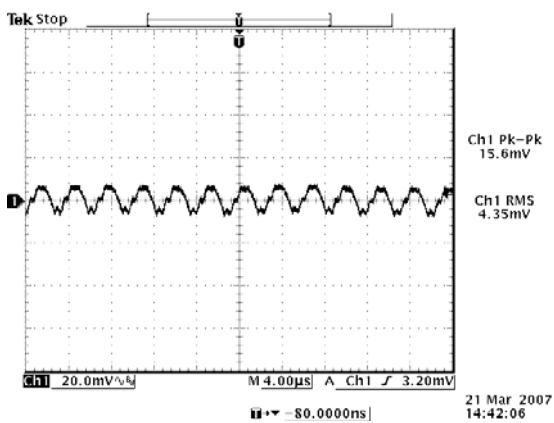

Ripple and noise at no load, 1.5 V output

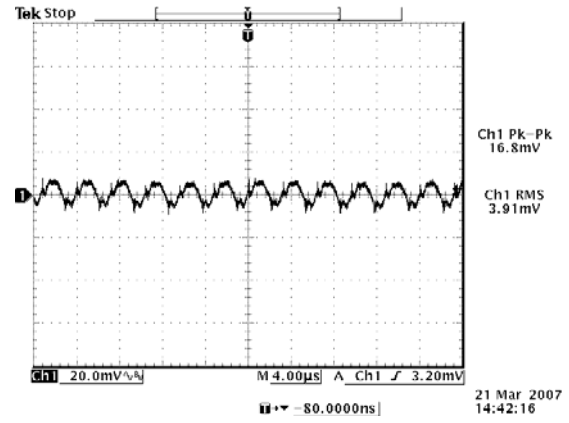

Ripple and noise at full load, 1.5 V output

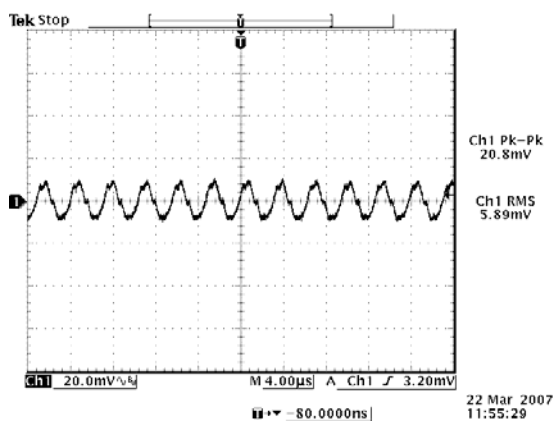

Ripple and noise at no load, 3.3 V output

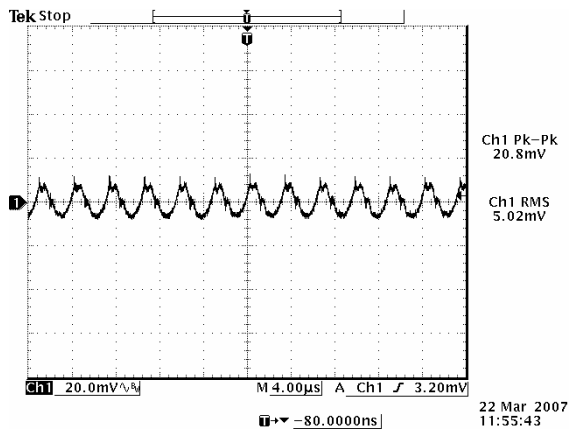

Ripple and noise at full load, 3.3 V output

**Note:** Ripple and noise at 5 V input, 0-20MHz BW, with 10 uF/10 V Tan Cap and 1uF/10 V ceramic cap at the output, Ta=25 deg C.

# Non-ISOLATED DC/DC CONVERTERS

5.0 Vdc Input, 0.8 Vdc - 3.6 Vdc/22 A Output



## Transient Response Waveforms

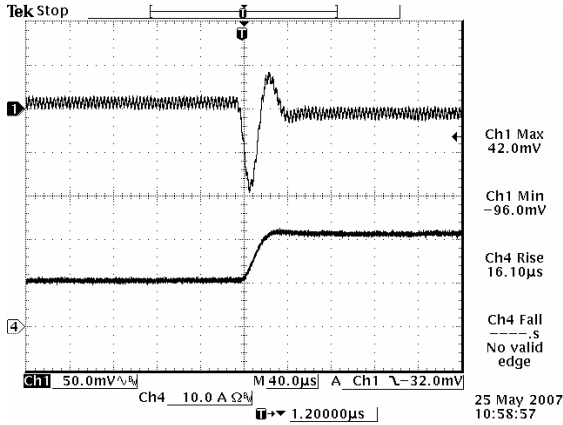

Vout=1.5 V 50% - 100% Load Transients

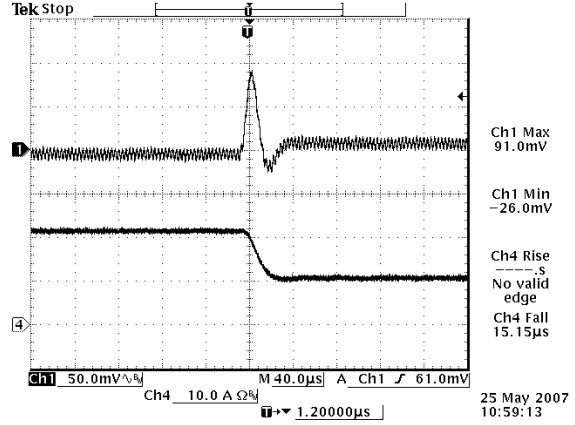

Vout=1.5 V 100% - 50% Load Transients

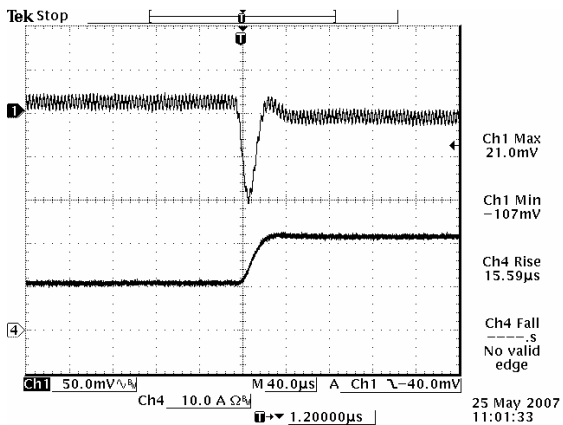

Vout=2.5 V 50% - 100% Load Transients

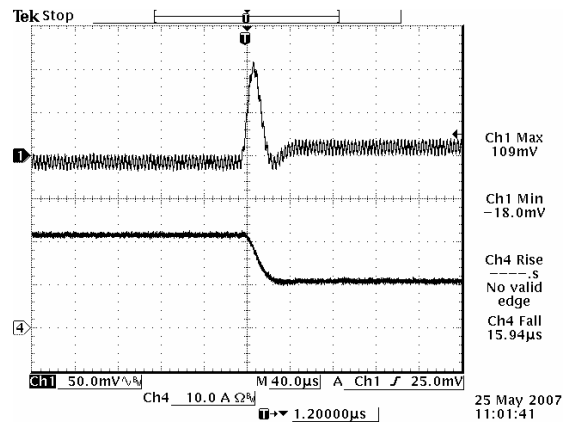

Vout=2.5 V 100% - 50% Load Transients

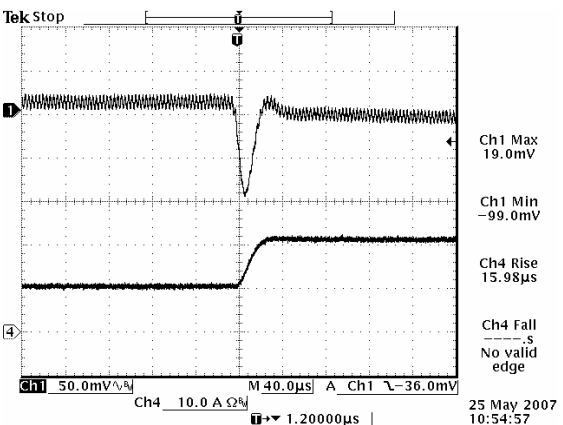

Vout=2.5 V 50% - 100% Load Transients

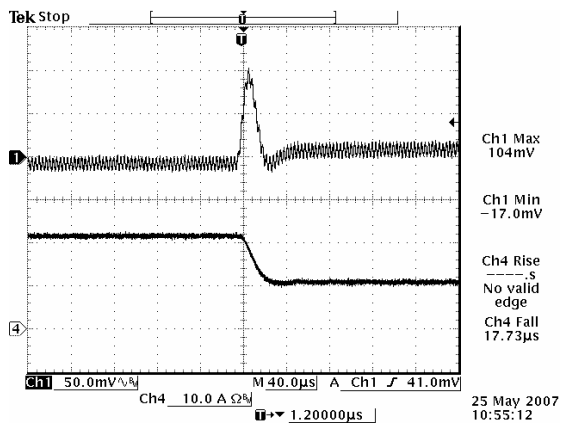

Vout=2.5 V 100% - 50% Load Transients

**Note:** Transient response at  $di/dt=1$  A/uS, with 330 uF/6.3V Tantalum Cap and 1uF/10 V Ceramic Cap at the output and  $T_a=25$  deg C.



# Non-ISOLATED DC/DC CONVERTERS

5.0 Vdc Input, 0.8 Vdc - 3.6 Vdc/22 A Output



## Mechanical Outline

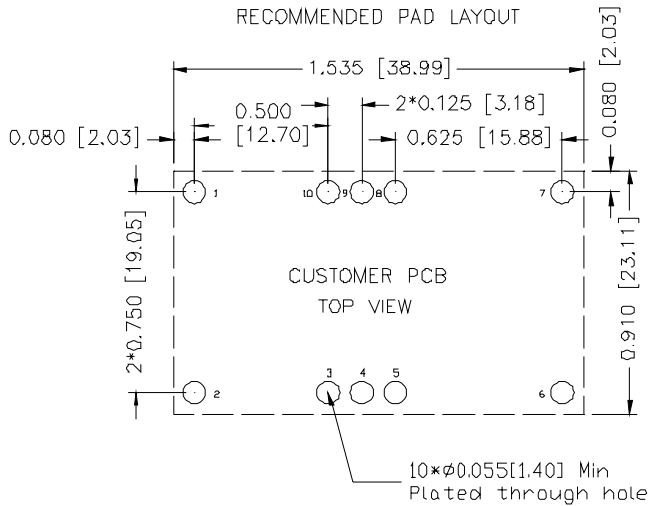
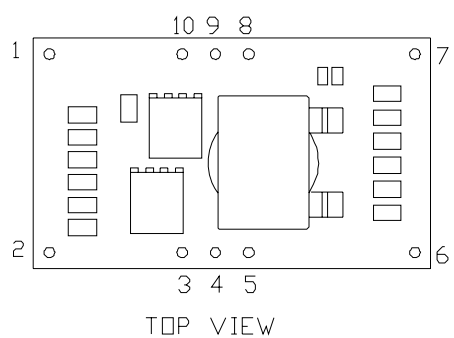
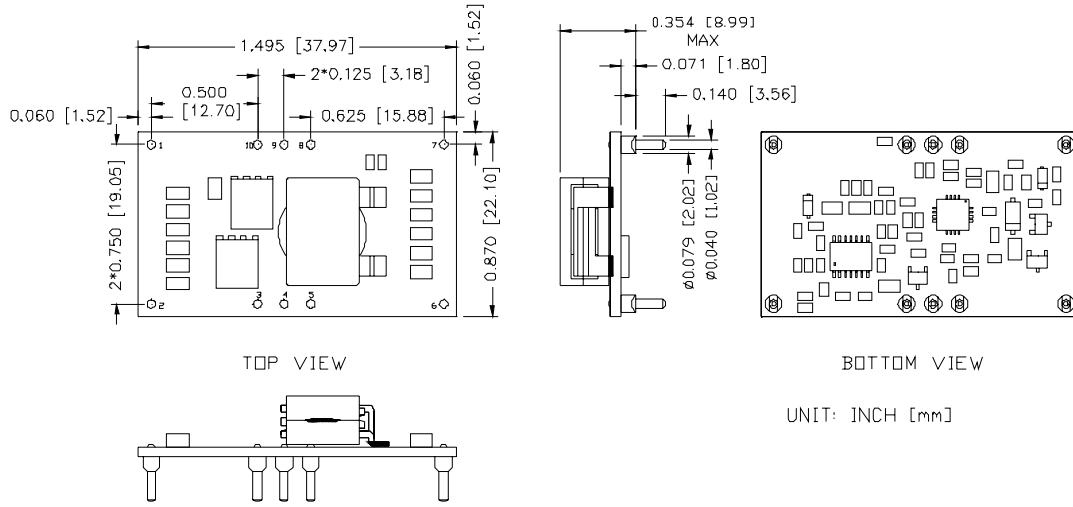

## Pin Connections

Pin	Function	Pin	Function
1	GND	6	Vout
2	Vin	7	GND
3	Remote	8	Track
4	Trim	9	Margen Down
5	Vo sence	10	Margen Up

**RoHS Compliance**  
 Complies with the European Directive 2002/95/EC, calling for the elimination of lead and other hazardous substances from electronic products.



©2007 Bel Fuse Inc. Specifications subject to change without notice. 060807

### CORPORATE

**Bel Fuse Inc.**  
 206 Van Vorst Street  
 Jersey City, NJ 07302  
 Tel 201-432-0463  
 Fax 201-432-9542  
[www.belfuse.com](http://www.belfuse.com)

### FAR EAST

**Bel Fuse Ltd.**  
 8F/ 8 Luk Hop Street  
 San Po Kong  
 Kowloon, Hong Kong  
 Tel 852-2328-5515  
 Fax 852-2352-3706  
[www.belfuse.com](http://www.belfuse.com)

### EUROPE

**Bel Fuse Europe Ltd.**  
 Preston Technology Management Centre  
 Marsh Lane, Suite G7, Preston  
 Lancashire, PR1 8UD, U.K.  
 Tel 44-1772-556601  
 Fax 44-1772-888366  
[www.belfuse.com](http://www.belfuse.com)