

Xcelite® Table of Contents

Xcelite®, founded in 1921, produces high quality tools for professional use. They are known throughout the electronics industry for a comprehensive line of screwdrivers, nutdrivers, convertible nutdriver/ screwdriver sets, interchangeable blade drivers, service tools and kits, pliers and cutters, shears, snips, wire strippers and wrenches. And now we've added Xcelite high quality tools for the electronic, electrical and telecommunication industries around the world, including crimping tools, and stripping tools for coaxial, optical and electrical cable.

Contents	Page No.
Xcelite® tool selection guide	397 - 399
Screwdrivers, Powered	400
Screwdrivers, Precision Electronic	400 - 401
Screwdrivers, Pro-series	401
Screwdrivers for slotted screws	402 - 406
Screwdrivers, Phillips®, and Torx®	407 - 408
Screwdriver sets	409
Screwdrivers, Allen hex socket type	410 - 411
Ballpoint style, Allen hex socket type	411 - 412
Scrulox type screwdrivers	413
Clutch head type screwdrivers	413
Combination reversible screwdrivers and kits	413 - 416
Interchangeable bit screwdrivers	416
Nutdrivers-fixed handles—inch and Metric sizes	416 - 420
Compact convertible tool sets	420 - 425
Series 99® blades, shanks, handles and kits	425 - 435
Series 99® compact interchangeable-blade sets	436 - 440
Plier selection information	441
Cutting capability guide	442
Diagonal cutting pliers	443 - 449
Diagonal end cutting pliers	449 - 450
Diagonal chain nose pliers	451
Diagonal long needle nose pliers	451 - 456
Needle nose pliers	457 - 458
Electronic shearcutters and pliers	459 - 461
Pliers and cutters	462 - 465
Utility Pliers	465 - 466
Special tools for special problems	466 - 471
Tweezers	472
Precision knives and blades	473 - 474
Multi-purpose tool kit	475
Xcelite® attaché tool cases	476 - 489
DataCom Cutters, Slitters and Testers	490 - 502
Tools for cable terminals and connectors	503 - 517



FEATURE CODES

- E = (Prefix) "Accu-Lite" Grips
- V = Blister carded
- J = Flush cutting edges
- K = Semi-flush cutting edges
- S = Coil spring
- W = Wire lead catcher
- G = Smooth jaws

"Many features are available on most Xcelite® products as a special for a small charge."

ACCU-LITE GRIPS

Many models are available with cushion handles for greater comfort and ease to the user.

XCELITE PACKAGING

Certain tools are available in a special, hanging display package. To order, add suffix "V." Example R184V is carded, R184 is not carded.

Phillips® is a registered trademark of The Phillips Screw Co.
Torx® is the trademark of Camcar Division of Textron Inc.
Allen® is a registered trademark of Holo Krane, Technology Corp.
Pozidriv® is a registered trademark of Camcar Division of Textron, Inc.
Belden® is a registered trademark of Belden, Inc.

Xcelite® Tool Selection Guide

Allen® Type Hex Socket Screws

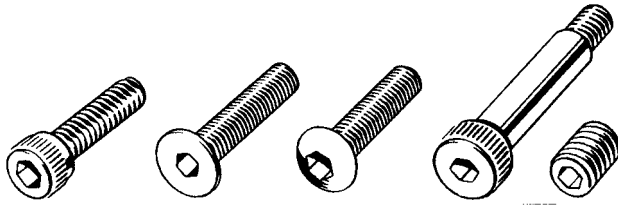

Xcelite driver
or blade

Cap screws 1960 series Nominal screw sizes	1936 series	Flat head cap screws	Button head cap screws	Shoulder screws	Set screws	Catalog number	Hex size (inches)
-	-	-	-	-	0	P18	.028
-	-	0	0	-	1&2	P19	.035
0	0&1	1&2	1&2	-	3&4	LN20, P20, 9920	.050
1	2	3&4	3&4	-	5&6	LN21, P21, 9921	1/16
2&3	3&4	5&6	5&6	-	8	LN22, P22, 9922	5/64
4&5	5&6	8	8	-	10	LN23, P23, 9923	3/32
6	-	-	-	-	-	LN764, P764, 99764	7/64
-	8	10	10	1/4	1/4	LN24, P24, 9924	1/8
8	-	-	-	-	-	LN964, P964, 99964	9/64
10	10&12	1/4	1/4	5/16	5/16	LN25, 9925	5/32
1/4	1/4	5/16	5/16	3/8	3/8	LN26, 9926	3/16
-	5/16	3/8	3/8	-	7/16	LN27	7/32
5/16	-	7/16	-	1/2	1/2	LN28	1/4

Note:

P Series = midjet drivers in PS89 sets.

LN Series = fixed handle drivers. Same size available also in LN20BP through LN28BP ballpoint fixed handle drivers.

Series 99® = interchangeable blades. Same sizes available also in 9920BP through 9926BP ballpoint blades.

See also offset ratchet screwdriver sets.

Phillips® Type Screws

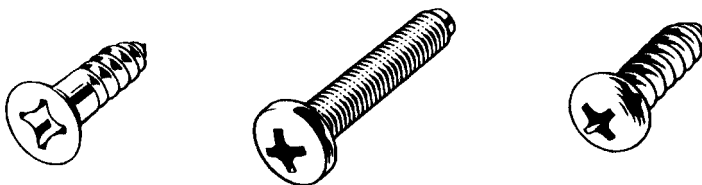

Xcelite driver
or blade

Wood screw		Machine screw		Sheetmetal	Flat, round oval, stove binding	Point size	Blade diameter (inches)
Flat oval	Round	Flat oval binding	Round fillister	Truss brazier button			
0.1	0.1	0.1	0.1	-	-	0	1/8
2, 3, 4	2, 3, 4	2, 3, 4	2, 3, 4	2, 3, 4, 5	2, 3, 4	1	3/16
5, 6, 7	5, 6, 7	5, 6, 8	5, 6, 8	6, 8, 10	5, 6, 7		
8, 9	8, 9, 10	10	10		8, 10	2	1/4
10, 12	12, 14	12, 1/4"	12, 1/4"	12, 1/4"	12, 14		
14, 16	16		5/16"			3	5/16
18, 20	18, 20	5/16", 3/8"	3/8", 7/16"	5/16", 3/8"	-		
24	24	7/16", 1/2"	1/2"	7/16", 1/2"		4	3/8

Note: See fixed handle drivers; compact convertible sets; Series 99® sets and interchangeable blades; combination reversible drivers, kits, and blades, offset ratchet screwdriver sets.

Xcelite® Tool Selection Guide

Bristol Type Multiple-spline Socket Screws

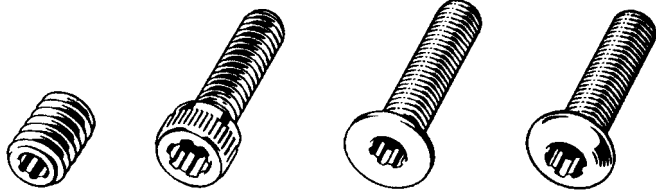

Xcelite blade

Set screws	Cap screws 1960 series	Flat head	Button head	Catalog number	Tip size (inches)	Number of flutes
No. 2-No. 3	-	No. 0	No. 0	9961	.048	6
No. 4	No. 0	No. 1-No. 2	No. 1-No. 2	9962	.060	6
No. 5	-	-	-	9963	.069	4
No. 5-No. 6	No. 1	No. 3-No. 4	99-64	9964	.072	6
No. 6	-	-	-	9965	.076	4
No. 8	No. 2-No. 3	No. 5-No. 6	No. 5-No. 6	9966	.096	6
No. 10	No. 4-No. 5	No. 8	No. 8	9967	.111	6
1/4"	-	No. 10	No. 10	-	.145	6
5/16"	No. 10	1/4"	1/4"	9969	.183	6

Note: See 99PS-60 compact interchangeable blade set and Series 99® blades.

Slotted Screws

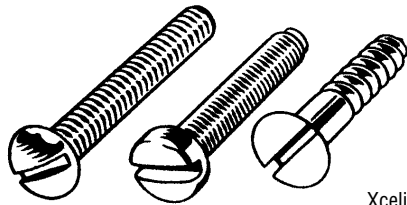

Xcelite driver or blade

Screw size	Tip size (inches)
0	3/32
1	3/32
2	1/8
3	5/32
4	3/16
5	3/16
6	1/4
7	1/4
8	5/16
9	5/16
10	5/16
12	3/8
14	3/8
16	7/16
18	7/16

Hex Head Screws

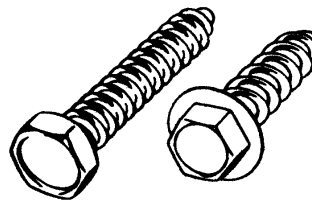

Xcelite driver or blade

Screw size	Screw diameter (inches)	Number*	Hex opening (inches)
1	.073	4	1/8
2	.086	4	1/8
3	.099	6	3/16
4	.112	6	3/16
5	.125	6	3/16
6	.138	8	1/4
7	.151	8	1/4
8	.164	8	1/4
10	.190	10	5/16
12	.216	10	5/16
1/8	.250	12	3/8
1/8	.312	16	1/2
1/8	.375	18	9/16

*See fixed handle drivers catalog numbers with or without prefix P, HS, A or AA, magnetic nutdrivers with suffix M; and Series 99® blades with prefix 99.

Note: See round and square blade fixed handle drivers, compact convertible sets, Series 99® kits and interchangeable blades, combination reversible blade drivers and kits, offset ratchet screwdriver sets.

Xcelite® Tool Selection Guide

Hex Head Bolts and Hex Head Cap Screws

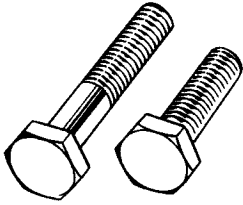

Xcelite nutdriver or blade

Bolt or screw size	Number*	Hex opening (inches)
1/4	14	7/16
5/16	16	1/2
3/8	18	9/16
7/16	20	5/8
1/2	24	3/4

*See fixed handle drivers catalog numbers with or without prefix P, HS, A, or AA; Magnetic nutdrivers with suffix M; and Series 99® blades with prefix 99.

Torx Screws

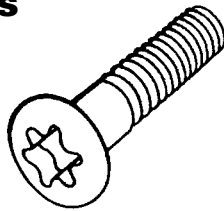

Xcelite Driver

Torx size	Catalog Number
T8	XTD8
T10	XTD10
T15	XTD15
T20	XTD20
T25	XTD25
T27	XTD27
T30	XTD30

Hex Nuts

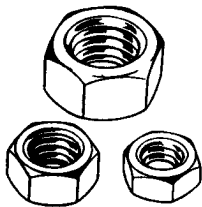

Xcelite nutdriver or blade

Nut size	Number*	Hex opening (inches)
1/4	14	7/16
5/16	16	1/2
3/8	18	9/16
7/16	22	11/16
1/2	24	3/4

*See fixed handle drivers catalog numbers with or without prefix P, HS, A, or AA; Magnetic nutdrivers with suffix M; and Series 99® blades with prefix 99.

Hex Machine Screw Nuts

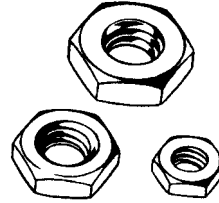

Xcelite nutdriver or blade

Nut size	For screw diameter	Number*	Hex opening (inches)
0	.060	5	5/32
1	.073	5	5/32
2	.086	6	3/16
3	.099	6	3/16
4	.112	8	1/4
5	.125	10	5/16
6	.138	10	5/16
8	.164	11	11/32
10	.190	12	3/8
12	.216	14	7/16
1/4	.250	14	7/16
5/16	.312	18	9/16
3/8	.375	20	5/8

*See fixed handle drivers catalog numbers with or without prefix P, HS, A or AA, magnetic nutdrivers with suffix M; and Series 99® blades with prefix 99.

Clutch Head Screws

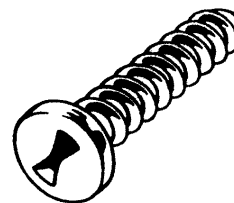

Xcelite driver or blade

Screw size	Tip size (inches)
2	3/32
3	3/32
4	3/32-1/8
6	1/8-5/32
8	5/32
10	5/32-3/16
12	3/16-1/4
14, 1/4	1/4
1/4	5/16
1/4	5/16

Note: See fixed handle drivers, Series 99® interchangeable blades, and combination reversible tools.

XP1 Cordless Driver



XP1 kit contains a driver, battery, battery charger, 3 bits, and 1 adapter for use with all Xcelite® Series 99® interchangeable bits

Features:

- Multi-stage clutch
- 2-speed control: Low speed of 180 RPMs; High speed of 360 RPMs
- 3.6v Nickel-Cadmium battery
- Battery charger for a quick 1 hour charge
- UL and cUL approved charger
- Motor: 3.6v DC
- Maximum clutch torque: Low 28.5 in. lbs.; High 14 in. lbs.
- Overall driver length is 10.8"

Cat No.	UPC No.	Packed	Description	Pack Wt.		Shelf Pack
				lb	kg	
XP1	037103142191	Boxed	Cordless driver kit with battery, charger, bits	2.6	1.16	1
XP1B	037103142177	Carded	Battery for cordless driver	0.4	0.18	1
XP1CHG	037103165329	Boxed	Battery charger for cordless driver	0.7	0.34	1

Precision Electronic Screwdriver Sets



- ESD safe to provide protection to ESD sensitive items
- Chrome-molybdenum vanadium steel blades provide superior strength
- Fast turning swivel caps w/cavity provides optimum control for precise centering
- Black oxide tips for longer wear life
- No-roll handle design keeps drivers from rolling off uneven surfaces
- Storage case provides a home and keeps drivers safe

Cat No.	UPC No.	Packed	Description	Shelf Pack
XP600	037103157513	Boxed	6 piece ESD safe slotted/Phillips screwdriver set with storage case	1
XPTX600	037103157720	Boxed	6 piece ESD safe Torx screwdriver set with storage case	1

XP600 contains 1 each of:

- 1.5mm x 60mm slotted tip screwdriver
- 2.0mm x 60mm slotted tip screwdriver
- 2.5mm x 60mm slotted tip screwdriver
- 3.0mm x 60mm slotted tip screwdriver
- #0 point Phillips tip screwdriver
- #00 point Phillips tip screwdriver

XPTX600 contains 1 each of:

- #5 point standard Torx tip screwdriver
- #6 point standard Torx tip screwdriver
- #7 point tamper-proof standard Torx tip screwdriver
- #8 point tamper-proof standard Torx tip screwdriver
- #10 point tamper-proof standard Torx tip screwdriver
- #15 point tamper-proof standard Torx tip screwdriver

Precision Electronic Screwdriver Sets

- Superior overall design for maximum control, accuracy and durability
- Chrome-molybdenum vanadium steel blades
- Fast-turning swivel caps with cavity for precise centering
- Precision tolerance black tips
- No-roll handle design

Kit Contents	
XP400	XP700
1.5mm Slotted	1.5mm Slotted
2.5mm Slotted	2.0mm Slotted
3.0mm Slotted	2.5mm Slotted
#0 Phillips®	3.0mm Slotted
	#00 Phillips®
	#0 Phillips®
	#1 Phillips®



XP700



XP400

Cat No.	UPC No.	Packed	Description	Shelf Pack
XP400	037103126733	Clamshell	4 piece set	1
XP700	037103126832	Clamshell	7 piece set	1

Pro-Series Electronic Screwdrivers and Sets

- The handle core is made of hard shockproof plastic for durability, while the outer coating is soft rubber for comfort and slip resistance
- ESD safe hard plastic core to protect sensitive components
- The handles are ergonomically designed, allowing sustained high torque with minimal slippage and muscle fatigue
- Smooth shatterproof seamless handle cap for minimal friction between hand and handle when screwdriver is being turned
- Narrow pinch grip for comfort and control
- Thumb bolster allows added downward force
- Satin finish chrome molybdenum steel shafts provide durability
- Specially treated black oxide tips eliminate light reflection



Cat No.	UPC No.	Packed	Blade Type	Blade Diameter		Blade Length		Shelf Pack
				Inch	mm	Inch	mm	
XPE101	037103153944	Boxed	Phillips®	3/16	4.76	3	76.20	12
XPE102	037103153869	Boxed	Phillips®	1/4	6.35	4	101.60	12
XPE144	037103153913	Boxed	Slotted	1/4	6.35	4	101.60	12
XPE184	037103153906	Boxed	Slotted	1/8	3.18	4	101.60	12
XPE3166	037103153920	Boxed	Slotted	3/16	4.76	6	152.40	12
XPE5166	037103153937	Boxed	Slotted	5/16	7.94	6	152.40	12
XPE5324	037103153890	Boxed	Slotted	5/32	3.97	4	101.60	12
XPES102	037103153883	Boxed	Slotted	1/4	6.35	1 5/16	33.34	12
XPES141	037103153876	Boxed	Slotted	1/4	6.35	1 1/4	31.75	12

Screwdriver Sets

Cat No.	UPC No.	Packed	Contents	Shelf Pack
XPE500	037103183323	Hanging Display Box	XPE101, XPE102, XPE3166, XPE144, XPE184	1
XPE700	037103153838	Hanging Display Box	XPE101, XPE102, XPE3166, XPE144, XPE184, XPE5324, XPE5166	1

Screwdrivers for Slotted Screws

Except where otherwise noted, all blades are AISI 6150 chrome vanadium steel, plated for protection.

Pocket Clip Style - Round Blade



- Blade made from AISI 6150 chrome vanadium steel

Cat No.	UPC No.	Packed	Blade Diameter		Length		Screwdriver Length		Shelf Pack
			Inch		Inch	mm	Inch	mm	
R3322	037103485656	Boxed	3/32		2	51	4 1/4	108	12
R3322V	037103485663	Carded	3/32		2	51	4 1/4	108	12
R3323	037103485670	Boxed	3/32		3	76	5 1/4	133	12
R3323V	037103488725	Carded	3/32		3	76	5 1/4	133	6
R3324	037103485687	Boxed	3/32		4	102	6 1/4	159	12
R3324V	037103488732	Carded	3/32		4	102	6 1/4	159	6
R181	037103485458	Boxed	1/8		2	51	4 1/4	108	12
R181V	037103485465	Carded	1/8		2	51	4 1/4	108	12
R183	037103485489	Boxed	1/8		3	76	5 1/4	133	6
R183V	037103488688	Carded	1/8		3	76	5 1/4	133	6

Display Cards



- Xcelite® Catalog No. 18120 consists of 20 each R181 pocket clip screwdrivers on display card
- Xcelite® Catalog No. 33220 consists of 20 each R3322 pocket clip screwdrivers on display card
- Xcelite® Catalog No. P12S20 consists of 20 each P12S pocket clip screwdrivers on display card

Cat No.	UPC No.	Description	Shelf Pack
18120	037103483676	Card - 20 of R181	1
33220	037103483683	Card - 20 of R3322	1
P12S20	037103484864	Card - 20 of P12S	1

Regular - Round Blade



Cat No.	UPC No.	Packed	Blade diameter		Blade length		Screwdriver length		Shelf Pack
			Inch	mm	Inch	mm	Inch	mm	
R182	037103485472	Boxed	1/8		2	51	4 5/8	117	6
R182V	037103488671	Carded	1/8		2	51	4 5/8	117	6
R183	037103485489	Boxed	1/8		3	76	5 1/4	133	6
R183V	037103488688	Carded	1/8		3	76	5 1/4	133	6
R184	037103485496	Boxed	1/8		4	102	6 5/8	168	6
R184V	037103485502	Carded	1/8		4	102	6 5/8	168	6
R186	037103485519	Boxed	1/8		6	152	8 5/8	219	6
R186V	037103485526	Carded	1/8		6	152	8 5/8	219	6
R188	037103485533	Boxed	1/8		8	203	10 5/8	270	6
R188V	037103485540	Carded	1/8		8	203	10 5/8	270	6
R1810	037103485571	Boxed	1/8		10	254	12 5/8	321	6
R5323	037103485731	Boxed	5/32		3	76	5 5/8	143	6
R5323V	037103488756	Carded	5/32		3	76	5 5/8	143	6
R5324	037103485748	Boxed	5/32		4	102	6 5/8	168	6
R5324V	037103486929	Carded	5/32		4	102	6 5/8	168	6
R5325	037103485755	Boxed	5/32		5	127	7 5/8	194	6
R5325V	037103485762	Carded	5/32		5	127	7 5/8	194	6
R5328	037103485779	Boxed	5/32		8	203	10 5/8	270	6
R5328V	037103485763	Carded	5/32		8	203	10 5/8	270	6
R3163	037103485588	Boxed	3/16		3	76	6 5/8	168	6
R3163V	037103485595	Carded	3/16		3	76	6 5/8	168	6
R3164	037103485601	Boxed	3/16		4	102	7 5/8	194	6
R3164V	037103485618	Carded	3/16		4	102	7 5/8	194	6
R3166	037103485625	Boxed	3/16		6	152	9 5/8	244	6
R3166V	037103485632	Carded	3/16		6	152	9 5/8	244	6
R3168	037103485649	Boxed	3/16		8	203	11 5/8	295	6
R3168V	037103488718	Carded	3/16		8	203	11 5/8	295	6
R31610	037103485786	Boxed	3/16		10	254	13 5/8	346	6
R144	037103485403	Boxed	1/4		4	102	8 1/8	206	6
R144V	037103485410	Carded	1/4		4	102	8 1/8	206	6
R146	037103485427	Boxed	1/4		6	152	10 1/8	257	6
R146V	037103485434	Carded	1/4		6	152	10 1/8	257	6
R148	037103485441	Boxed	1/4		8	203	12 1/8	308	6
R148V	037103488664	Carded	1/4		8	203	12 1/8	308	6
R1410	037103485564	Boxed	1/4		10	254	14 1/8	359	6
R1410V	037103488701	Carded	1/4		10	254	14 1/8	359	6
R5164	037103485694	Boxed	5/16		4	102	8 1/2	216	6
R5166	037103485700	Boxed	5/16		6	152	10 1/2	267	6
R5168	037103485724	Boxed	5/16		8	203	12 1/2	317	6
R388	037103485557	Boxed	3/8		8	203	12 1/2	317	6

Round Blade Screwdriver Set



- Xcelite® Catalog No. SDR11 consists of 5 round blade screwdrivers for slotted screws (R182, R5324, R3166, R144 and R5166)

Cat No.	UPC No.	Packed	Description	Shelf Pack
SDR11	037103486103	Pouch	5 round blade screwdrivers for slotted screws	1

Stubby - Square Blade



Cat No.	UPC No.	Packed	Blade diameter		Blade length		Screwdriver length		Shelf Pack
			Inch	mm	Inch	mm	Inch	mm	
S3161	037103485922	Boxed	3/16		1 1/4	32	3 1/4	83	6
S141	037103485854	Boxed	1/4		1 1/4	32	3 1/4	83	6
S141V	037103486936	Carded	1/4		1 1/4	32	3 1/4	83	6
S5161	037103486011	Boxed	5/16		1 1/4	32	3 1/4	83	6

Regular - Square Blade



Cat No.	UPC No.	Packed	Blade diameter		Blade length		Screwdriver Length		Shelf Pack
			Inch		Inch	mm	Inch	mm	
S3163	037103485939	Boxed	3/16		3	76	6 5/8	168	6
S3164	037103485953	Boxed	3/16		4	702	7 5/8	194	6
S3164V	037103485960	Carded	3/16		4	702	7 5/8	194	6
S3166	037103485977	Boxed	3/16		6	152	9 5/8	244	6
S3168	037103485991	Boxed	3/16		8	203	11 5/8	295	6
S144	037103485861	Boxed	1/4		4	102	8 1/8	206	6
S144V	037103485878	Carded	1/4		4	102	8 1/8	206	6
S146	037103485885	Boxed	1/4		6	152	10 1/8	257	6
S148	037103485908	Boxed	1/4		8	203	12 1/8	308	6
S5164	037103486028	Boxed	5/16		4	102	8 1/2	216	6
S5166	037103486035	Boxed	5/16		6	152	10 1/2	216	6
S5168	037103486059	Boxed	5/16		8	203	12 1/2	317	6
S51610	037103486066	Boxed	5/16		10	254	14 1/2	368	6
S388	037103485915	Boxed	3/8		8	203	12 1/2	317	6
S3812	037103486004	Boxed	3/8		12	305	18	457	6
S71612	037103486073	Boxed	7/16		12	305	18	457	6
S71618	037103486080	Boxed	7/16		18	457	24	610	6

Square Blade Screwdriver Set

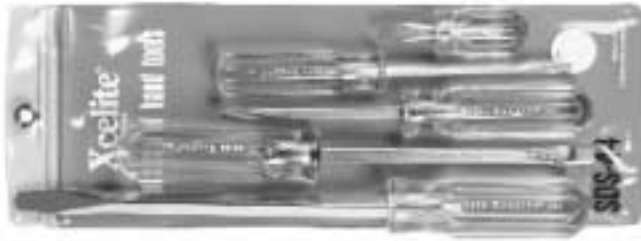

- Xcelite® Catalog No. SDS44 consists of 5 square blade screwdrivers for slotted screws (S141, S3164, S144, S5166 and S388)

Cat No.	UPC No.	Packed	Description	Shelf Pack
SDS44	037103486110	Pouch	5 square blade screwdrivers for slotted screws	1

Screwdrivers for Recess Head Screws

Pocket clip style - Phillips® type



Cat No.	UPC No.	Packed	Point size	Blade diameter Inch	Blade length		Screwdriver length		Shelf Pack
					Inch	mm	Inch	mm	
P12S	037103484857	Boxed	0	1/8	2	51	4 1/4	108	12
P12SV	037103486905	Carded	0	1/8	2	51	4 1/4	108	12

Stubby - Phillips® Type



Cat No.	UPC No.	Packed	Point size	Blade diameter Inch	Blade length		Screwdriver length		Shelf Pack
					Inch	mm	Inch	mm	
SX101	037103486226	Boxed	1	3/16	1 7/16	37	3 7/16	87	6
SX102	037103486233	Boxed	2	1/4	1 5/16	33	3 3/8	86	6

Regular – Phillips® Type



Cat No.	UPC No.	Packed	Point size	Blade diameter		Blade length		Screwdriver length		Shelf Pack
				Inch	mm	Inch	mm	Inch	mm	
X100	037103486370	Boxed	0	1/8	2	50	4 5/8	117	6	
X100V	037103486387	Carded	0	1/8	2	50	4 5/8	117	6	
X101	037103486394	Boxed	1	3/16	3	76	6 5/8	168	6	
X101V	037103486400	Carded	1	3/16	3	76	6 5/8	168	6	
X108	037103486462	Boxed	1	3/16	6	152	9 5/8	244	6	
X108V	037103486479	Carded	1	3/16	6	152	9 5/8	244	6	
X102	037103486417	Boxed	2	1/4	4	102	8 1/8	206	6	
X102V	037103486424	Carded	2	1/4	4	102	8 1/8	206	6	
X103	037103486431	Boxed	3	5/16	6	152	10 1/2	267	6	
X103V	037103486448	Carded	3	5/16	6	152	10 1/2	267	6	
X104	037103486455	Boxed	4	3/8	8	203	12 1/2	317	6	

Extra long – Phillips® Type



Cat No.	UPC No.	Packed	Point size	Blade diameter		Blade length		Screwdriver length		Shelf Pack
				Inch	mm	Inch	mm	Inch	mm	
X1010	037103486486	Boxed	1	3/16	10	254	13 5/8	346	6	
X1020	037103486493	Boxed	2	1/4	10	254	14 1/8	359	6	

Super-tru Tip – Phillips® Type

- Super-tru tip for longer wear life and reduction of damage to screw head recesses, especially in smaller size fasteners
- Specially treated and finished tips with black oxide for ultimate control
- Bright, nickel chrome-plated blades



Cat No.	UPC No.	Packed	Point size	Blade diameter		Blade length		Screwdriver length		Shelf Pack
				Inch	mm	Inch	mm	Inch	mm	
XST100	037103486738	Boxed	0	1/8	2	50	4 5/8	117	6	
XST100V	037103486745	Carded	0	1/8	2	50	4 5/8	117	6	
XST101	037103486752	Boxed	1	3/16	3	76	6 5/8	168	6	
XST101V	037103486769	Carded	1	3/16	3	76	6 5/8	168	6	
XST102	037103486776	Boxed	2	1/4	4	102	8 1/8	206	6	
XST102V	037103486783	Carded	2	1/4	4	102	8 1/8	206	6	
XST1010	037103486790	Boxed	1	3/16	10	254	13 5/8	371	6	
XST1020	037103486806	Boxed	2	1/4	10	254	14 1/8	371	6	

Screwdrivers for Torx® Head Screws



XTD20

Cat No.	UPC No.	Packed	Tip size	Blade length		Screwdriver length		Shelf Pack
				Inch	mm	Inch	mm	
XTD6	037103490551	Boxed	T-6	3	76	6 5/8	168	6
XTD6V	037103490568	Carded	T-6	3	76	6 5/8	168	6
XTD8	037103490407	Boxed	T-8	3	76	6 5/8	168	6
XTD8V	037103490414	Carded	T-8	3	76	6 5/8	168	6
XTD8XL	037103491305	Boxed	T-8	9 3/4	248	13 3/8	340	6
XTD10	037103488039	Boxed	T-10	3	76	6 5/8	168	6
XTD10V	037103488046	Carded	T-10	3	76	6 5/8	168	6
XTD10XL	037103491312	Boxed	T-10	9 3/4	248	13 3/8	340	6
XTD15	037103488053	Boxed	T-15	3	76	6 5/8	168	6
XTD15V	037103488060	Carded	T-15	3	76	6 5/8	168	6
XTD15XL	037103491329	Boxed	T-15	9 3/4	248	13 3/8	340	6
XTD20	037103488077	Boxed	T-20	3	76	6 5/8	168	6
XTD20V	037103488084	Carded	T-20	3	76	6 5/8	168	6
XTD25	037103488091	Boxed	T-25	3	76	6 5/8	168	6
XTD25V	037103488107	Carded	T-20	3	76	6 5/8	168	6
XTD27	037103488114	Boxed	T-27	4 1/2	105	8 5/8	220	6
XTD27V	037103488121	Carded	T-27	4 1/2	105	8 5/8	220	6
XTD30	037103488138	Boxed	T-30	4 1/2	105	8 5/8	220	6
XTD30V	037103488145	Carded	T-30	4 1/2	105	8 5/8	220	6

Screwdrivers – Tamper-proof Torx®



Cat No.	UPC No.	Packed	Tip size	Screwdriver length		Shelf Pack
				Inch	mm	
XTD8TPV	037103044914	Carded	T-8	4	102	6
XTD10TPV	037103045256	Carded	T-10	4	102	6
XTD15TPV	037103045317	Carded	T-15	4	102	6

Driver sets



SDX22



191



XST3



XST5

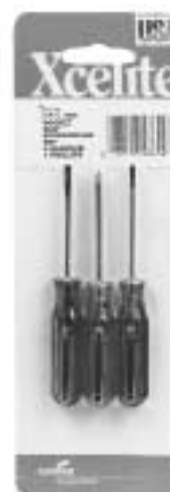

SD3V

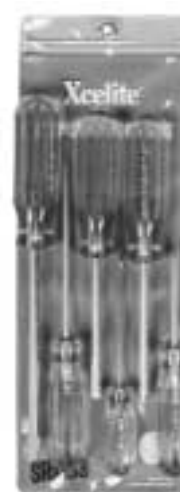

SRX33

- **SDX22** contains Phillips Xcelite® Catalog No. X100, X101, X102, X103, SX102
- **191** contains Xcelite® Catalog No. 5MM, 55MM, 6MM, 7MM, 8MM, 9MM and 10MM
- **XST3** contains Super-tru tip Phillips Xcelite® Catalog No. XST100, XST101, XST102
- **XST5** contains Super-tru Phillips Xcelite® Catalog No. XST100, XST101, XST102, XST1010 and XST1020
- **SD3V** contains pocket clip screwdrivers R181 and R3322 for slotted screws and P12S for Phillips head screws
- **SRX33** contains blades for slotted screws Xcelite® Catalog No. R184, R3166, R144, R5166 and Phillips Xcelite® Catalog No. X101 and X102

Cat No.	UPC No.	Packed	Shelf Description	Pack
SDX22	037103486127	Pouch	5 pieces – all Phillips	1
191	037103095435	Pouch	7 pieces - all regular drilled shaft metric nutdrivers	1
XST3	037103487353	Pouch	3 pieces – all Super-tru tip Phillips type	1
XST5	037103487360	Pouch	5 pieces – all Super-tru tip Phillips type	1
SD3V	037103486097	Carded	3 pocket clip screwdrivers for Phillips head screws	1
SRX33	037103486219	Pouch	6 pieces – 4 round blade for slotted screws and 2 Phillips types	1

Screwdrivers for Recessed Socket Head Screws

Allen Hex Socket Type - Inch Sizes - Amber Handles



LN25



LN20

Cat No.	UPC No.	Packed	Blade diameter		Blade length		Screwdriver length		Shelf Pack
			Inch	mm	Inch	mm	Inch	mm	
LN20	037103484468	Boxed	.050		4	102	6 5/8	168	6
LN21	037103484475	Boxed	1/16		4	102	6 5/8	168	6
LN21V	037103488275	Carded	1/16		4	102	6 5/8	168	6
LN22	037103484482	Boxed	5/64		4	102	6 5/8	168	6
LN22V	037103488282	Carded	5/64		4	102	6 5/8	168	6
LN23	037103484499	Boxed	3/32		4	102	7 1/8	190	6
LN23V	037103488299	Carded	3/32		4	102	7 1/8	190	6
LN764	037103484550	Boxed	7/64		4	102	7 1/8	190	6
LN24	037103484505	Boxed	1/8		4	102	7 1/8	190	6
LN964	037103484567	Boxed	9/64		4	102	7 1/8	190	6
LN25	037103484512	Boxed	5/32		6	152	9 1/8	232	6
LN26	037103484529	Boxed	3/16		6	152	10 1/8	257	6
LN27	037103484536	Boxed	7/32		6	152	10 1/8	257	6
LN28	037103484543	Boxed	1/4		6	152	10 1/8	257	6

Metric Sizes - Black Handles



Cat No.	UPC No.	Packed	Blade diameter		Blade length		Screwdriver length		Shelf Pack
			Inch/ mm		Inch	mm	Inch	mm	
LN127MM	037103484260	Boxed	1.27		-	102	-	168	6
LN15MM	037103484277	Boxed	1.5		-	102	-	168	6
LN2MM	037103484284	Boxed	2		-	102	-	168	6
LN25MM	037103484291	Boxed	2.5		-	102	-	181	6
LN3MM	037103484307	Boxed	3		-	102	-	181	6
LN4MM	037103484314	Boxed	4		-	102	-	181	6
LN5MM	037103484321	Boxed	5		-	102	-	181	6
LN6MM	037103484338	Boxed	6		-	102	-	181	6

Roll-up Kits for Allen® Hex Socket Type

- Complete set of LN series Allen hex socket type and metric size screwdrivers
- Roll-up canvas case, plastic-coated for wear and protection



Cat No.	UPC No.	Packed	Description	Shelf Pack
LN11	037103484451	Canvas case	Complete set of LN series Allen hex type screwdrivers	1
LN8MM	037103484345	Canvas case	Complete set of 8 drivers w/black handles in metric sizes	1

Ballpoint Style, Allen® Hex Socket Type

- Unique “ballpoint” tip makes Xcelite® drivers ideal for tightening and removing Allen type socket head screws in out-of-reach places or merely when wanting an easier, quicker way to drive them home
- Will engage screw head from any angle
- Slips easily into sockets and holds securely without reaming, because ends are precision-machined to close tolerance

Inch Sizes – Amber Handles

- For easier tightening and removing of Allen type socket head screws
- Ballpoint tip



Cat No.	UPC No.	Packed	Blade diameter		Blade length		Screwdriver length		Shelf Pack
			Inch	mm	Inch	mm	Inch	mm	
LN20BP	037103484574	Boxed	.050		4	102	6 5/8	168	6
LN21BP	037103484581	Boxed	1/16		4	102	6 5/8	168	6
LN22BP	037103484598	Boxed	5/64		4	102	6 5/8	168	6
LN23BP	037103484604	Boxed	3/32		4	102	7 1/8	181	6
LN764BP	037103484666	Boxed	7/64		4	102	7 1/8	181	6
LN24BP	037103484611	Boxed	1/8		4	102	7 1/8	181	6
LN964BP	037103484673	Boxed	9/64		4	102	7 1/8	181	6
LN25BP	037103484628	Boxed	5/32		4	102	7 1/8	181	6
LN26BP	037103484635	Boxed	3/16		4	102	8 1/8	206	6
LN28BP	037103484659	Boxed	1/4		4	102	8 1/8	206	6

Metric Sizes - Black Handles



- For easier tightening and removing of Allen type socket head screws
- Ballpoint tip

Cat No.	UPC No.	Packed	Blade diameter Inch/ mm	Blade length		Screwdriver length		Shelf Pack
				Inch	mm	Inch	mm	
LN127MMBP	037103484352	Boxed	1.27	-	102	-	168	6
LN15MMBP	037103484369	Boxed	1.5	-	102	-	168	6
LN2MMBP	037103484376	Boxed	2	-	102	-	168	6
LN25MMBP	037103484383	Boxed	2.5	-	102	-	181	6
LN3MMBP	037103484390	Boxed	3	-	102	-	181	6
LN4MMBP	037103484406	Boxed	4	-	102	-	181	6
LN5MMBP	037103484413	Boxed	5	-	102	-	181	6

Roll-up Kits for Ballpoint Style Allen® Hex Socket Type

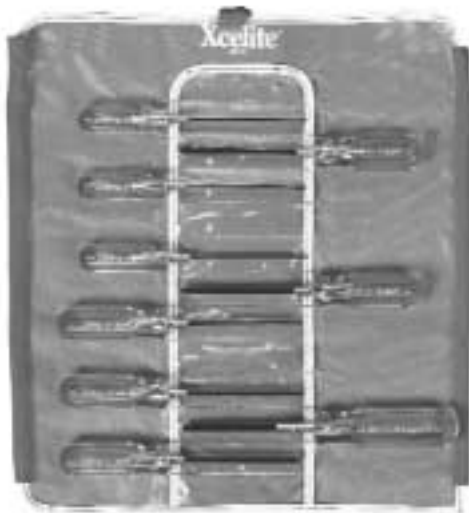

- Ballpoint, Allen hex socket type screwdrivers
- Roll-up canvas case

Cat No.	UPC No.	Packed	Description	Shelf Pack
LN8MMBP	037103484437	Canvas case	Metric sizes – 8 ballpoint, Allen hex socket type screwdrivers	1
LN9BP	037103484444	Canvas case	Inch sizes – 9 ballpoint, Allen hex socket type screwdrivers	1

Scrulox Type - Color Coded Handles

- All shanks plated for protection
- Color-coded handles



SL2

Cat No.	UPC No.	Packed	Point size	Handle Color	Blade length		Screwdriver length		Shelf Pack
					Inch	mm	Inch	mm	
SL0V	037103486141	Carded	0	Amber	3 1/2	89	7 5/8	194	6
SL1V	037103486165	Carded	1	Green	3 1/2	89	7 5/8	194	6
SL2	037103486172	Boxed	2	Red	3 1/2	89	7 5/8	194	6
SL2V	037103488022	Carded	2	Red	3 1/2	89	7 5/8	194	6
SL3V	037103486202	Carded	3	Black	3 1/2	89	7 5/8	194	6

Clutch Head Type

- Furnished in type "G" design
- Amber handles



Cat No.	UPC No.	Packed	Hex diameter	Blade diameter		Blade length		Screwdriver length		Shelf Pack
			Inch	Inch	mm	Inch	mm	Inch	mm	
G5324	037103483997	Boxed	5/32	3/16	5	4	102	7 5/8	194	6

Combination Reversible Screwdrivers and Kits

- Economical multi-purpose tool sets and kits consisting of either a regular or stubby handle combined with one or more of reversible, interchangeable combination blades
- Blades and handle may be purchased separately
- Blades snap in and out easily and are held firmly in perfect alignment by patented spring lock

Handle



Cat No.	UPC No.	Packed	Description	Handle dimensions		Shelf Pack
				Inch x Inch	mm x mm	
25	037103481337	Boxed	Series 99® screwdriver handle	1 1/8 x 4 1/8	29 x 105	6

Reversible Blades (Use with Number 25 Handle)

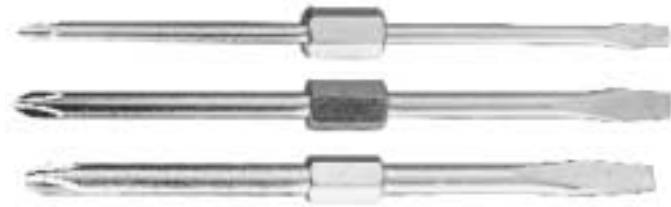

- Snaps in and out easily and held firmly in perfect alignment by patented spring lock

Cat No.	UPC No.	Packed	Blade diameter		Description	Blade length		Shelf Pack
			Inch	mm		Inch	mm	
RB1	037103485793	Boxed	3/16	5	No. 1 Phillips – 3/16" slotted	6 1/4	159	6
RB2	037103485809	Boxed	1/4	6	No. 2 Phillips – 1/4" slotted	6 1/4	159	6
RB3	037103485816	Boxed	5/16	8	No. 3 Phillips – 5/16" slotted	6 1/4	159	6

Combination Reversible Blades and Handles



- Contains 1 reversible, interchangeable, combination blade
- Regular handle

Cat No.	UPC No.	Packed	Description	Screwdriver length		Shelf Pack
				Inch	mm	
CR1	037103483904	Boxed	No. 25 handle & RB1 blade	7 1/4	184.15	6
CR1V	037103483911	Carded	No. 25 handle & RB1 blade	7 1/4	184.15	6
CR2	037103483928	Boxed	No. 25 handle & RB2 blade	7 1/4	184.15	6
CR2V	037103483935	Carded	No. 25 handle & RB2 blade	7 1/4	184.15	6

Plastic View Kit

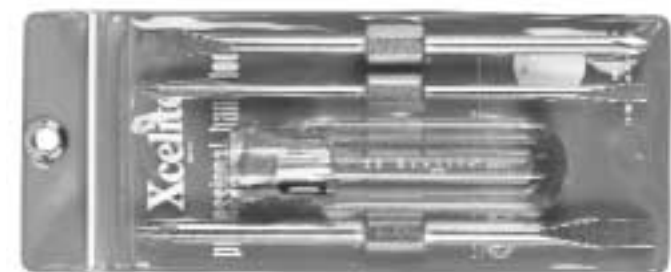

- Zipper case

CK23

Cat No.	UPC No.	Description	Shelf Pack
CK20	037103483881	Zipper case with RB1, RB2 blades and No. 25 handle	6
CK23	037103483898	Zipper case with RB1, RB2 and RB3 blades and No. 25 handle	6

Pocket Roll Kit

- Contains RB1, RB2 and RB3 blades and Xcelite® Catalog No. 25 handle



Cat No.	UPC No.	Description	Shelf Pack
CK3	037103483874	Contains RB1, RB2 and RB3 blades with No. 25 handle	6

4-way Pocket Tool

- Extremely versatile time-saver
- Handy for removing backs of TV sets and installing antennas
- Special reversible SB1 blade fits slotted or Phillips head screws
- Double-ended handle serves as 2 sizes of nutdrivers (7/16" and 1/4")



Cat No.	UPC No.	Packed	Description	Shelf Pack
600	037103483690	Boxed	4-way pocket tool	6
600V	037103483706	Carded	4-way pocket tool	6

Four-in-One Screwdriver

- Extra handy
- 2 blades also interchangeable with Two-In-One
- Self-storing standard shaft
- Converts in seconds to 4 most often needed tips (3/16" and 1/4" slotted tips and Xcelite® Catalog No. 1 and 2 Phillips)
- FSD1CS packed on a clip strip merchandising wand



Cat No.	UPC No.	Packed	Description	Shelf Pack
FSD1	037103487537	Boxed	Four-in-One screwdriver complete	6
FSD1V	037103487605	Carded	Four-in-One screwdriver complete	6

Two-in-One Screwdriver



- 3/16" slotted tip end and Xcelite® Catalog No. 1 Phillips
- Stubby handle

Cat No.	UPC No.	Packed	Description	Shelf Pack
TSD1V	037103487612	Carded	Two-in-one screwdriver complete	6

Interchangeable Bit Screwdriver



- Chrome/Nickel plated for longer life
- Industrial quality tool steel bits, heat treated, tempered and stress relieved blast finished
- Made in the USA

Cat No.	UPC No.	Description	Handle Color	Tool Weight oz	Tool Weight g	Shelf Pack
8SD1V	037103146335	8-in-1 Interchangeable Bit Screwdriver	Blue	3.5	99	6

Nutdrivers - Fixed Handle

- Features steel shafts
- Precision-machined, cold-drawn, case-hardened sockets with bright finish
- Molded firm grip
- Plastic handles are color-coded for easy size identification
- Xcelite® offers a variety of nutdriver blades that fit interchangeably in special handles
- See pages 425, 426, and 427

Regular - Drilled Shaft



- Precision-machined, cold-drawn, case-hardened socket with bright finish
- Regular, plastic color-coded handles for ease in size identification
- Molded firm grip

Cat No.	UPC No.	Packed	Color code	Diameter Inch	Depth of hole	Blade length Inch	Blade length mm	Nutdriver length Inch	Nutdriver length mm	Shelf Pack
6	037103481054	Boxed	Black	3/16	1 1/8"	3	76	6 1/8	156	6
6V	037103481078	Carded	Black	3/16	1 1/8"	3	76	6 1/8	156	6
7	037103481085	Boxed	Brown	7/32	1 1/8"	3	76	6 1/8	156	6
8	037103481108	Boxed	Red	1/4	1 1/8"	3	76	6 1/8	156	6
8V	037103481146	Carded	Red	1/4	1 1/8"	3	76	6 1/8	156	6
9	037103481153	Boxed	Orange	9/32	1 1/8"	3	76	6 1/8	156	6
10	037103481177	Boxed	Amber	5/16	1 1/8"	3	76	6 1/8	156	6
10V	037103481214	Carded	Amber	5/16	1 1/8"	3	76	6 1/8	156	6
11	037103481221	Boxed	Green	11/32	1 1/8"	3	76	6 1/8	156	6
12	037103481252	Boxed	Blue	3/8	1 1/8"	3	76	6 1/8	156	6
12V	037103481276	Carded	Blue	3/8	1 1/8"	3	76	6 1/8	156	6
14	037103481290	Boxed	Brown	7/16	1 7/8"	2 7/8	73	7	178	6
14V	037103481306	Carded	Brown	7/16	1 7/8"	2 7/8	73	7	178	6
16V	037103481320	Carded	Red	1/2	1 7/8"	2 7/8	73	7	178	6

Regular - Full Hollow Shaft - Inch Sizes

Color Coded Handles

- Precision-machined, cold-drawn, case-hardened socket with bright finish
- Molded firm grip



Cat No.	UPC No.	Packed	Color code	Blade diameter Inch	Depth of hole	Blade length		Screwdriver length		Shelf Pack
						Inch	mm	Inch	mm	
HS6	037103484031	Boxed	Black	3/16	6"	3 1/8	79	6 1/4	159	6
HS6V	037103484048	Carded	Black	3/16	6"	3 1/8	79	6 1/4	159	6
HS7	037103484055	Boxed	Brown	7/32	6"	3 1/8	79	6 1/4	159	6
HS7V	037103490278	Carded	Brown	7/32	6"	3 1/8	79	6 1/4	159	6
HS8	037103484062	Boxed	Red	1/4	7"	3 1/8	79	7 1/4	184	6
HS8V	037103484079	Carded	Red	1/4	7"	3 1/8	79	7 1/4	184	6
HS9	037103484086	Boxed	Orange	9/32	7"	3 1/8	79	7 1/4	184	6
HS9V	037103488657	Carded	Orange	9/32	7"	3 1/8	79	7 1/4	184	6
HS10	037103484093	Boxed	Amber	5/16	7"	3 1/8	79	7 1/4	184	6
HS10V	037103484109	Carded	Amber	5/16	7"	3 1/8	79	7 1/4	184	6
HS11	037103484116	Boxed	Green	11/32	7"	3 1/8	79	7 1/4	184	6
HS11V	037103484123	Carded	Green	11/32	7"	3 1/8	79	7 1/4	184	6
HS12	037103484130	Boxed	Blue	3/8	7"	3 1/8	79	7 1/4	184	6
HS12V	037103484147	Carded	Blue	3/8	7"	3 1/8	79	7 1/4	184	6
HS14	037103484154	Boxed	Brown	7/16	7"	3 1/8	79	7 1/4	184	6
HS14V	037103484161	Carded	Brown	7/16	7"	3 1/8	79	7 1/4	184	6
HS16	037103484178	Boxed	Red	1/2	7"	3 1/8	79	7 1/4	184	6
HS16V	037103484185	Carded	Red	1/2	7"	3 1/8	79	7 1/4	184	6
HS18	037103484192	Boxed	Orange	9/16	7"	3 1/8	79	7 1/4	184	6
HS18V	037103484208	Carded	Orange	9/16	7"	3 1/8	79	7 1/4	184	6

Extra Long - Full Hollow Shaft - Inch Sizes

Color Coded Handles

- Precision-machined, cold-drawn, case-hardened socket with bright finish
- Molded firm grip



Cat No.	UPC No.	Packed	Color code	Blade diameter Inch	Depth of hole	Blade length		Screwdriver length		Shelf Pack
						Inch	mm	Inch	mm	
L6	037103483713	Boxed	Black	3/16	8 3/4"	6	152	9 1/8	232	6
L8	037103483720	Boxed	Red	1/4	9 3/4"	6	152	10 1/8	257	6
L8V	037103483751	Carded	Red	1/4	9 3/4"	6	152	10 1/8	257	6
L10	037103483768	Boxed	Amber	5/16	9 3/4"	6	152	10 1/8	257	6
L10V	037103483799	Carded	Amber	5/16	9 3/4"	6	152	10 1/8	257	6
L11	037103483805	Boxed	Green	11/32	9 3/4"	6	152	10 1/8	257	6
L12	037103483829	Boxed	Blue	3/8	9 3/4"	6	152	10 1/8	257	6
L12V	037103483836	Carded	Blue	3/8	9 3/4"	6	152	10 1/8	257	6

Magnetic Nutdrivers



- Ultimate in convenience for assembly and service operations involving hex fasteners
- Alnico permanent magnet inserted in socket holds fasteners firmly for easy, one-hand driving or for retrieving or removal
- Socket specially treated and hardened for use with self-tapping screws
- Unique Xcelite® development effectively insulates magnet
- Exclusive with Xcelite® 1/4" and 5/16" magnetic fixed handle
- Comfortable contoured handle provides adequate torque for 1-hand driving

Cat No.	UPC No.	Packed	Handle color	Diameter Inch	Depth of hole	Blade length		Tool length		Shelf Pack
						Inch	mm	Inch	mm	
8M	037103481115	Boxed	Red	1/4	-	3	76	6 1/8	156	6
8MV	037103481139	Carded	Red	1/4	-	3	76	6 1/8	156	6
10M	037103481184	Boxed	Amber	5/16	-	3	76	6 1/8	156	6
L8M	037103483737	Boxed	Red	1/4	-	6	152	10 1/8	257	6
L8MV	037103483744	Carded	Red	1/4	-	6	152	10 1/8	257	6
L10M	037103483775	Boxed	Amber	5/16	-	6	152	10 1/8	257	6
L10MV	037103483782	Carded	Amber	5/16	-	6	152	10 1/8	257	6
LL8M	037103483843	Boxed	Red	1/4	-	16 3/4	444	20 7/8	552	6
LL10M	037103483850	Boxed	Amber	5/16	-	16 3/4	444	20 7/8	552	6

Metric Nutdrivers

- Manufactured precisely to metric dimension
- Particularly useful in the assembly and servicing of foreign equipment
- Bright finished blades, shafts and shanks (same as English version)

Regular - Drilled Shaft - Metric Sizes, Black Handles



- Particularly useful in assembly and servicing of foreign equipment
- Bright finished blades, shafts and shanks
- Manufactured precisely to metric dimension

Cat No.	UPC No.	Packed	Blade Diameter mm	Depth of hole mm	Blade Length mm	Tool Length mm	Thread diameter		Hex nuts mm	Shelf Pack
							cap screws mm	Hex head mm		
4MM	037103481009	Boxed	4	29	76	156	-	-	2	6
45MM	037103481016	Boxed	4.5	29	76	156	-	-	2.3	6
5MM	037103481030	Boxed	5	29	76	156	2.6	-	2.6	6
55MM	037103481047	Boxed	5.5	29	76	156	3	-	3	6
6MM	037103481061	Boxed	6	29	76	156	3.5	-	3.5	6
7MM	037103481092	Boxed	7	29	76	156	4	-	4	6
8MM	037103481122	Boxed	8	29	76	156	5	-	5	6
10MM	037103481191	Boxed	10	48	73	178	6	-	6	6
11MM	037103481238	Boxed	11	48	73	178	7	-	7	6

Full - Hollow Shaft

- Particularly useful in assembly and servicing of foreign equipment
- Bright finished blades, shafts and shanks
- Manufactured precisely to metric dimension



Cat No.	UPC No.	Packed	Color code	Blade Diameter mm	Depth of hole mm	Blade length Inch	mm	Nutdriver length Inch	mm	Shelf Pack
12MM	037103481269	Boxed	Black	12	178	-	79	-	184	6
13MM	037103481283	Boxed	Black	13	178	-	79	-	184	6

Color Coded Nutdriver Sets - “Tray Bien”

- Contains assortment of nutdrivers listed in chart
- Convenient blow molded case



Cat No.	UPC No.	Description	Shelf Pack
127TB	037103483621	Contains solid shaft No's. 6, 7, 8, 9, 10, 11 and 12	1
147TB	037103483638	Contains hollow shaft No's. HS8, HS9, HS10, HS11, HS12, HS14, and HS166	1

Nutdriver Set

- Contains assortment of nutdrivers listed in chart
- Plastic pouch



Cat No.	UPC No.	Description	Shelf Pack
157	037103483652	Contains 7 pieces, all regular drilled shaft No's. 6, 8, 10, 11, 12, 14 and 16	1
177	037103483669	Contains 7 pieces, all hollow shaft No's. HS6, HS8, HS10, HS11, HS12, HS14 and HS16	1

Nutdriver Kit - "Keep and Carry" Case



- Contains assortment of nutdrivers listed in chart
- Sturdy yellow plastic case for inch sizes, and red case for metric sizes, keeps nutdrivers orderly on work bench and carries them on service calls

Cat No.	UPC No.	Description	Shelf Pack
HS618	037103484215	Inch sizes - Contains hollow shaft No's. HS6, HS7, HS8, HS9, HS10, HS11, HS12, HS14, HS16, and HS18	1
413MM	037103481023	Metric sizes - 10 piece set of nutdrivers: 4MM through 8MM, 10MM, 11MM, 13MM. All have 31.35mm depth shaft hole	1

Compact Convertible Tool Sets

- Compact convertible tool sets complete more jobs with fewer tools, save bench space and lighten service kits
- Each set is equipped with a remarkable black, "piggyback" torque amplifier handle (Xcelite® Catalog No. TA2) that slips over the top of color-coded midget drivers to provide larger gripping surface, extended reach and increased driving power
- Sets housed in attractive, easy to open, clear plastic cases
- All individual screwdrivers and nutdrivers are available separately

PS88 Screwdriver Set - Inch Sizes



- Handles more jobs with fewer tools, saves bench space and lightens service kit
- Equipped with remarkable black, "piggyback" torque amplifier handle
- Set housed in attractive, easy to open, clear plastic case
- Color-coded handles

Cat No.	UPC No.	Packed	Handle color	Blade length		Screwdriver length		Shelf Pack
				Inch	mm	Inch	mm	
PS88	037103485236	Boxed	Complete set					3
PS88V	037103485243	Carded	Complete set carded					3
P3321	037103485052	-	Green	3/32	-	3 1/2	89	12
P181	037103485021	-	Red	1/8	-	3 1/2	89	12
P5321	037103485069	-	Black	5/32	-	3 1/2	89	12
P3161	037103485045	-	Orange	3/16	-	3 1/2	89	12
P141	037103485014	-	Amber	1/4	-	3 1/2	89	12
P0	037103484710	-	Blue	0 Phillips	-	3 1/2	89	12
P1	037103484727	-	Brown	1 Phillips	-	3 1/2	89	12
P2	037103484734	-	Amber	2 Phillips	-	3 1/2	89	12
TA2	037103486240	-	Black	Torque amplifier handle				6

PS7 Screwdriver and Nutdriver Set - Inch Sizes

- Handles more jobs with fewer tools, saves bench space and lightens service kit
- Equipped with remarkable black, “piggyback” torque amplifier handle
- Set housed in attractive, easy to open, clear plastic case
- Color-coded handles



Cat No.	UPC No.	Packed	Handle color	Diameter Inch	Driver length		Shelf Pack
					Inch	mm	
PS7	037103485199	Boxed	Complete set				3
Screwdrivers							
P3161	037103485045	-	Orange	3/16	3 1/2	89	12
P3321	037103485052	-	Green	3/32	3 1/2	89	12
P0	037103484710	-	Blue	0 Phillips	3 1/2	89	12
P1	037103484727	-	Brown	1 Phillips	3 1/2	89	12
Nutdrivers							
P8	037103484796	-	Red	1/4	3 1/2	89	12
P10	037103484826	-	Amber	5/16	3 1/2	89	12
TA2	037103486240	-	Black	Torque amplifier handle	3		

PS120 Nutdriver Set - Inch Sizes

- Handles more jobs with fewer tools, saves bench space and lightens service kit
- Equipped with remarkable black, “piggyback” torque amplifier handle
- Set housed in attractive, easy to open, clear plastic case
- Color-coded handles



Cat No.	UPC No.	Packed	Handle color	Diameter Inch	Nutdriver length		Shelf Pack
					Inch	mm	
PS120	037103485281	Boxed	Complete set			3	
PS120V	037103485298	Carded	Complete set carded			3	
P3	037103484741	-	Blue	3/32	3 1/2	89	12
P4	037103484758	-	Red	1/8	3 1/2	89	12
P5	037103484765	-	Amber	5/32	3 1/2	89	12
P6	037103484772	-	Black	3/16	3 1/2	89	12
P7	037103484789	-	Brown	7/32	3 1/2	89	12
P8	037103484796	-	Red	1/4	3 1/2	89	12
P9	037103484819	-	Orange	9/32	3 1/2	89	12
P10	037103484826	-	Amber	5/16	3 1/2	89	12
P11	037103484833	-	Green	11/32	3 1/2	89	12
P12	037103484840	-	Blue	3/8	3 1/2	89	12
TA2	037103486240	-	Black	Torque amplifier handle			3

PS121 MM Metric Compact Convertible Nutdriver Set



- Handles more jobs with fewer tools, saves bench space and lightens service kit
- Equipped with remarkable black, “piggyback” torque amplifier handle
- Set housed in attractive, easy to open, clear plastic case

Cat No.	UPC No.	Packed	Diameter mm	Nutdriver length mm	Shelf Pack
PS121MM	037103485304	Boxed	Complete set		3
△ P3MM	037103485076	-	3	89	12
△ P35MM	037103485083	-	3.5	89	12
P45MM	037103485106	-	4.5	89	12
P5MM	037103485113	-	5	89	12
P55MM	037103485120	-	5.5	89	12
P7MM	037103485144	-	7	89	12
P8MM	037103485151	-	8	89	12
P10MM	037103485168	-	10	89	12
TA2	037103486240	-	Torque amplifier handle		3

△ = Made to order, contact customer service for delivery.

PS130 Screwdriver and Nutdriver Set - Inch Sizes

- Handles more jobs with fewer tools, saves bench space and lightens service kit
- Equipped with remarkable black, "piggyback" torque amplifier handle
- Set housed in attractive, easy to open, clear plastic case
- Color-coded handles



Cat No.	UPC No.	Packed	Handle color	Blade Diameter Inch	Diameter Inch	Shelf Pack
PS130	037103485311	Boxed	Complete set			3
PS130V	037103485328	Carded	Complete set carded			3
Screwdrivers						
P1	037103484727	-	Brown	1 Phillips	-	12
P2	037103484734	-	Amber	2 Phillips	-	12
P181	037103485021	-	Red	1/8	-	12
P3161	037103485045	-	Orange	3/16	-	12
P141	037103485014	-	Amber	1/4	-	12
Nutdrivers						
P6	037103484772	-	Black	-	3/16	12
P8	037103484796	-	Red	-	1/4	12
P10	037103484826	-	Amber	-	5/16	12
P11	037103484833	-	Green	-	11/32	12
P12	037103484840	-	Blue	-	3/8	12
TA2	037103486240	-	Black	Torque amplifier handle		3

PS89 Screwdriver Set for Hex Socket Screws - Inch Sizes



- Handles more jobs with fewer tools, saves bench space and lightens service kit
- Equipped with remarkable black, “piggyback” torque amplifier handle
- Set housed in attractive, easy to open, clear plastic case
- Red handles

Cat No.	UPC No.	Packed	Diameter Inch	Tool length		Shelf Pack
				Inch	mm	
PS89	037103485250	Boxed	Complete set			3
PS89V	037103485267	Carded	Complete set carded			3
P18	037103484871	-	.028	3 1/2	89	12
P19	037103484888	-	.035	3 1/2	89	12
P20	037103484895	-	.050	3 1/2	89	12
P21	037103484901	-	1/16	3 1/2	89	12
P22	037103484918	-	5/64	3 1/2	89	12
P23	037103484925	-	3/32	3 1/2	89	12
P764	037103485038	-	7/64	3 1/2	89	12
TA2	037103486240	-	Torque amplifier handle			3

PS90MM Compact Convertible Hex Socket Screwdriver Set

Metric Sizes



- Handles more jobs with fewer tools, saves bench space and lightens service kit
- Equipped with remarkable black, “piggyback” torque amplifier handle
- Set housed in attractive, easy to open, clear plastic case
- Black handles

Cat No.	UPC No.	Packed	Diameter mm	Tool length		Shelf Pack
				mm	mm	
PS90MM	037103485274	Boxed	Complete set			3
P78	037103485007	-	0.89	89		12
P71	037103484949	-	1.27	89		12
P72	037103485917	-	1.5	89		12
P73	037103484956	-	2.0	89		12
P74	037103484963	-	2.5	89		12
P75	037103484970	-	3.0	89		12
P76	037103484987	-	4.0	89		12
P77	037103484994	-	5.0	89		12
P78	037103485007	-	0.89	89		12
TA2	037103486240	-	Torque amplifier handle			3

M60 Mini-driver Kit - Inch Sizes

- Miniature version of compact convertible set
- For precise detailed work
- Mini-drivers consist of jeweler's type and Phillips screwdriver blades molded in color-coded plastic handles
- Contains a black torque amplifier handle (Xcelite® Catalog No. M06) 7/8" X 3 1/16"/22.22mm X 77.78mm
- Furnished in see-through plastic case
- Mini-drivers available separately
- Color-coded handles



Cat No.	UPC No.	Packed	Handle color	Blade Diameter		Blade length		Tool length		Shelf Pack
				Inch	mm	Inch	mm	Inch	mm	
M60	037103484680	Boxed	-	Complete set						6
M60V	037103484697	Carded	-	Complete set carded						6
M01	037103490667	-	Amber	.04	1	7/8	22	2 1/8	54	6
M02	037103490674	-	Orange	.055	1	7/8	22	2 1/8	54	6
M03	037103490681	-	Brown	.07	2	7/8	22	2 1/8	54	6
M04	037103490698	-	Red	.08	2	7/8	22	2 1/8	54	6
M05	037103490704	-	Green	.10	3	7/8	22	2 1/8	54	6
M06	037103124807	-	Black	Torque amplifier handle			-		-	

Series 99® Blades, Shanks, and Handles

- Series 99® interchangeable blades, shanks and handles shown on these pages are all available separately, allowing gradual, economical accumulation of whatever items might be needed for individual requirements
- Also permits owners of Series 99® sets or kits to enlarge them or substitute tools, as necessary, at minimal cost

Handles

- Easy to operate
- Use with Series 99® blades



Cat No.	UPC No.	Packed	Description	Color	Handle dimensions		Shelf Pack
					Inch x Inch	mm x mm	
991	037103482532	Boxed	Regular	Amber	13/16 x 4	30 x 102	6
991V	037103482549	Carded	Regular	Amber	13/16 x 4	30 x 102	6
992	037103482570	Boxed	Junior	Amber	11/16 x 3 1/8	27 x 79	6
992V	037103482587	Carded	Junior	Amber	11/16 x 3 1/8	27 x 79	6
993	037103482594	Boxed	Stubby	Amber	13/16 x 2	30 x 51	6
993V	037103487025	Carded	Stubby	Amber	13/16 x 2	30 x 51	6
994	037103482600	Boxed	Tee	Black	3 1/2 x 1 5/8	89 x 41	6
994V	037103482655	Carded	Tee	Black	3 1/2 x 1 5/8	89 x 41	6

Reversible Ratcheting Handles



- Easy to operate
- Permits extremely simple 1-hand operation, even in tight quarters
- Use with Series 99® blades
- Smooth precise action
- Left-right-neutral marking indicator
- Light ratcheting drag facilitates turning and prevents fasteners from reversing

Cat No.	UPC No.	Packed	Description	Color	Inch x Inch	mm x mm	Shelf Pack
991R	037103482556	Boxed	Regular	Black	1 3/16 x 5 1/4	30 x 133	6
991RV	037103482563	Carded	Regular	Black	1 3/16 x 5 1/4	30 x 133	6
994R	037103482631	Boxed	Tee	Black	3 1/2 x 2 1/2	89 x 64	6
994RV	037103482648	Carded	Tee	Black	3 1/2 x 2 1/2	89 x 64	6

Nutdrivers - Inch Sizes



Cat No.	UPC No.	Packed	Diameter Inch	Approximate working length		Shelf Pack
				Inch	mm	
996	037103482693	Boxed	3/16	3 5/8	92	6
996V	037103482709	Carded	3/16	3 5/8	92	6
997	037103482716	Boxed	7/32	3 5/8	92	6
997V	037103482730	Carded	7/32	3 5/8	92	6
998	037103482747	Boxed	1/4	3 5/8	92	6
998V	037103482785	Carded	1/4	3 5/8	92	6
99S8	037103482396	Boxed	1/4	1 3/8	36	6
999	037103482792	Boxed	9/32	3 5/8	92	6
999V	037103482815	Carded	9/32	3 5/8	92	6
9910	037103482822	Boxed	5/16	3 5/8	92	6
9910V	037103482846	Carded	5/16	3 5/8	92	6
99S10	037103482402	Boxed	5/16	1 3/8	36	6
9911	037103482853	Boxed	11/32	3 5/8	92	6
9911V	037103482877	Carded	11/32	3 5/8	92	6
9912	037103482884	Boxed	3/8	3 5/8	92	6
9912V	037103482891	Carded	3/8	3 5/8	92	6
99S12	037103482419	Boxed	3/8	1 3/8	36	6
9914	037103482907	Boxed	7/16	4	102	6
9914V	037103482914	Carded	7/16	4	102	6
9916	037103482921	Boxed	1/2	4	102	6
9916V	037103482938	Carded	1/2	4	102	6



Magnetic Nutdrivers - Inch Sizes



Cat No.	UPC No.	Packed	Diameter		Approximate working length		Shelf Pack
			Inch	mm	Inch	mm	
998M	037103482754	Boxed	1/4		3 5/8	92	6
998MV	037103482778	Carded	1/4		3 5/8	92	6
9910M	037103482945	Boxed	5/16		3 5/8	92	6
9910MV	037103482952	Carded	5/16		3 5/8	92	6



Nutdrivers - Metric Sizes



Cat No.	UPC No.	Packed	Diameter		Approximate working length		Shelf Pack
			mm	Inch	mm	Inch	
994MM	037103482617	Boxed	4	-		92	6
9945MM	037103482624	Boxed	4.5	-		92	6
995MM	037103482662	Boxed	5	-		92	6
9955MM	037103482679	Boxed	5.5	-		92	6
996MM	037103482686	Boxed	6	-		92	6
997MM	037103482723	Boxed	7	-		92	6
998MM	037103482761	Boxed	8	-		92	6
999MM	037103482808	Boxed	9	-		92	6
9910MM	037103482839	Boxed	10	-		102	6
9911MM	037103482860	Boxed	11	-		102	6
Magnetic							
997MMM	037103003898	Boxed	7	-		92	6



Slotted Screwdrivers



Cat No.	UPC No.	Packed	Diameter		Approximate working length		Shelf Pack
			Inch	mm	Inch	mm	
99125	037103483379	Boxed	1/8		4	102	6
99125V	037103483386	Carded	1/8		4	102	6
99811	037103483447	Boxed	3/16		4	102	6
99811V	037103483454	Carded	3/16		4	102	6
99250	037103483393	Boxed	1/4		4	102	6
99250V	037103483409	Carded	1/4		4	102	6
99312	037103483416	Boxed	5/16		4	102	6
99312V	037103483423	Carded	5/16		4	102	6

Phillips®



Cat No.	UPC No.	Packed	Description	Approximate working length		Shelf Pack
				Inch	mm	
99820	037103483461	Boxed	No. 0	4	102	6
99820V	037103483478	Carded	No. 0	4	102	6
99821	037103483485	Boxed	No. 1	4	102	6
99821V	037103483492	Carded	No. 1	4	102	6
99822	037103483508	Boxed	No. 2	4	102	6
99822V	037103483515	Boxed	No. 2	4	102	6

Pozidriv®



Cat No.	UPC No.	Packed	Description	Approximate working length		Shelf Pack
				Inch	mm	
99831	037103483522	Boxed	No. 1	4	102	6
99832	037103483539	Boxed	No. 2	4	102	6
99833	037103483546	Boxed	No. 3	4	102	6

Screwdrivers - Allen® Hex Socket Type



Inch Sizes



Cat No.	UPC No.	Packed	Diameter Inch	Approximate working length		Shelf Pack
				Inch	mm	
9920	037103482969	Boxed	.050	4	102	6
9921	037103482983	Boxed	1/16	4	102	6
9922	037103483003	Boxed	5/64	4	102	6
9923	037103483027	Boxed	3/32	4	102	6
99764	037103483102	Boxed	7/64	4	102	6
9924	037103483041	Boxed	1/8	4	102	6
99964	037103483119	Boxed	9/64	4	102	6
9925	037103483065	Boxed	5/32	4	102	6
9926	037103483089	Boxed	3/16	4	102	6

○ Screwdrivers - Allen® Hex Socket Type

Metric Sizes



Cat No.	UPC No.	Packed	Diameter mm	Approximate working length Inch	Approximate working length mm	Shelf Pack
9971MM	037103483232	Boxed	1.27	-	102	6
9972MM	037103483249	Boxed	1.5	-	102	6
9973MM	037103483256	Boxed	2.0	-	102	6
9974MM	037103483263	Boxed	2.5	-	102	6
9975MM	037103483270	Boxed	3.0	-	102	6
9976MM	037103483287	Boxed	4.0	-	102	6
9977MM	037103483294	Boxed	5.0	-	102	6

○ Screwdrivers - Ballpoint Allen® Hex Socket Type

Inch Sizes



Cat No.	UPC No.	Packed	Diameter Inch	Approximate working length Inch	Approximate working length mm	Shelf Pack
9920BP	037103482976	Boxed	.050	4	102	6
9921BP	037103482990	Boxed	1/16	4	102	6
9922BP	037103483010	Boxed	5/64	4	102	6
9923BP	037103483034	Boxed	3/32	4	102	6
99764BP	037103483430	Boxed	7/64	4	102	6
9924BP	037103483058	Boxed	1/8	4	102	6
99964BP	037103483553	Boxed	9/64	4	102	6
9925BP	037103483072	Boxed	5/32	4	102	6
9926BP	037103483096	Boxed	3/16	4	102	6

○ Screwdrivers - Ballpoint Allen® Hex Socket Type

Metric Sizes

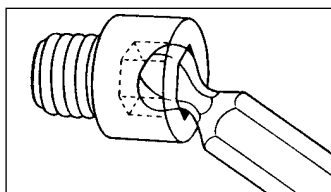

Cat No.	UPC No.	Packed	Diameter mm	Approximate working length Inch	Approximate working length mm	Shelf Pack
9971MMBP	037103483300	Boxed	1.27	-	102	6
9972MMBP	037103483317	Boxed	1.5	-	102	6
9973MMBP	037103483324	Boxed	2.0	-	102	6
9974MMBP	037103483331	Boxed	2.5	-	102	6
9975MMBP	037103483348	Boxed	3.0	-	102	6
9976MMBP	037103483355	Boxed	4.0	-	102	6
9977MMBP	037103483362	Boxed	5.0	-	102	6

Screwdrivers - Bristol 6-flute Multiple Spline



Cat No.	UPC No.	Packed	Description	Diameter		Approximate working length		Shelf Pack
				Inch	mm	Inch	mm	
9961	037103483140	Boxed		0.048	1.22	4	102	6
9962	037103483157	Boxed		0.060	1.52	4	102	6
9963	037103483164	Boxed	4 flute	0.069	1.75	4	102	6
9964	037103483171	Boxed		0.072	1.82	4	102	6
9965	037103483188	Boxed	4 flute	0.076	1.93	4	102	6
9966	037103483195	Boxed		0.096	2.43	4	102	6
9967	037103483201	Boxed		0.111	2.82	4	102	6
9969	037103493224	Boxed		0.183	4.65	4	102	6

Screwdrivers - Clutch Head



Cat No.	UPC No.	Packed	Description	Diameter		Approximate working length		Shelf Pack
				Inch	mm	Inch	mm	
99G316	037103482204	Boxed		3/16		4	102	6
99G532	037103482211	Boxed		5/32		4	102	6

Screwdrivers - Scrulox



Cat No.	UPC No.	Packed	Description	Approximate working length		Shelf Pack
				Inch	mm	
99SL1	037103482440	Boxed	No. 1	4	102	6
99SL2	037103482457	Boxed	No. 2	4	102	6
99SL3	037103491510	Boxed	No. 3	4	102	6

Screwdrivers - Tamper Proof-Torx®



Cat No.	UPC No.	Packed	Tip Size	Approximate working length		Shelf Pack
				Inch	mm	
998XTDTP	037103045294	Boxed	T-8	4	102	6
9910XTDTP	037103045263	Boxed	T-10	4	102	6
9915XTDTP	037103045270	Boxed	T-15	4	102	6



Screwdrivers – Torx®



Cat No.	UPC No.	Packed	Tip Size	Approximate working length		Shelf Pack
				Inch	mm	
996XTD	037103490575	Boxed	T-6	4	102	6
998XTD	037103490582	Boxed	T-8	4	102	6
9910XTD	037103490025	Boxed	T-10	4	102	6
9915XTD	037103490032	Boxed	T-15	4	102	6
9920XTD	037103490049	Boxed	T-20	4	102	6
9925XTD	037103490056	Boxed	T-25	4	102	6
9927XTD	037103490063	Boxed	T-27	4	102	6
9930XTD	037103490070	Boxed	T-30	4	102	6

Reamer



Cat No.	UPC No.	Packed	Diameter		Approximate working length		Shelf Pack
			Inch x Inch	mm x mm	Inch	mm	
9938	037103483126	Boxed	1/8 x 3/8	3.17 x 9.52	4	102	6
9938V	037103483133	Carded	1/8 x 3/8	3.17 x 9.52	4	102	6

Extensions



Cat No.	UPC No.	Packed	Description	Approximate working length		Tool Length		Shelf Pack
				Inch	mm	Inch	mm	
99X5	037103482501	Boxed	Extension	4	102	4	102	6
99X5V	037103482518	Carded	Extension	4	102	4	102	6
99X10	037103482525	Boxed	Extension	7	178	7	178	6
99X10V	037103487063	Carded	Extension	7	178	7	178	6

Power Bit Adapter

- For use with Xcelite® Series 99® blades
- Fits all power tools with 1/4" hex chuck



Cat No.	UPC No.	Packed	Description	Shelf Pack
99PA	037103490926	Boxed	Power bit adapter	6
99PAV	037103490933	Carded	Power bit adapter	6

Series 99® Service Kits

- Series 99® service kits and sets made primarily of various screwdrivers, nutdrivers and other blades that can be used interchangeably in Series 99® handles
- All blades are high quality steel, hardened and tempered for optimum performance
- Plastic handles have patented spring device that holds blades firmly, yet permits quick, easy insertion and removal
- Regular handles accommodate all blades, single and reversible
- Stubby, Tee and Ratchet handles used only with single-end blades

99SM & 99SMX Roll Kit & Case

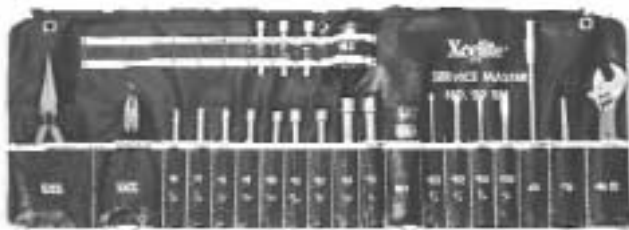

99SM

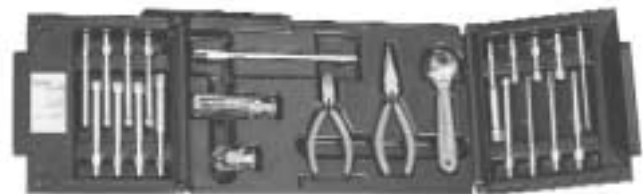

99SMX

- Versatile 23-piece set of quality tools
- Provides a variety of quick change tools and tool combinations to speed up assembly and service work
- Available in a durable, roll-up plastic coated canvas case, or hard plastic case, for easy selection and storage

Cat No.	UPC No.	Packed	Inch	mm	Description	Shelf Pack
99SM	037103482471	Boxed	-		Complete roll kit	1
99SMK	037103482488	Boxed	-	-	Canvas case	1
99SMX	037103490254	Boxed	-	-	Complete tool kit w/carrying case	1
52CGV	037103481559	-	6	152	Long nose cushion grip plier	6
55CG	037103481603	-	5	127	Diagonal cushion grip plier	6
46CG	037103481467	-	6	152	Thin-pattern cushion grip adjustable wrench	6
991	037103482532	-	-	-	Regular handle	6
993	037103482594	-	-	-	Stubby handle	6
996 to 9916	-	-	-	-	Regular nutdrivers (9)	-
99S8, 99S10, 99S12	-	-	-	-	Stubby nutdrivers	-
99821, 99822	-	-	-	-	Phillips screwdrivers	-
99811, 99250	-	-	-	-	Slotted screwdrivers	-
9938	037103483126	-	-	-	Reamer	6
99X10	037103482525	-	-	-	Extension	6

99PR Roll Kit

- Multi-purpose, 14-piece nutdriver and screwdriver set



Cat No.	UPC No.	Packed	Inch	mm	Description	Shelf Pack
99PR	037103482266	Boxed	-	-	Complete roll kit	1
99K	037103482228	Boxed	-	-	Canvas case	1
991	037103482532	-	-	-	Regular handle	6
996 to 9916	-	-	-	-	Nutdrivers	-
99811, 99250	-	-	-	-	Slotted screwdrivers	-
99821, 99822	-	-	-	-	Phillips screwdrivers	-

99SPC Personal Computer Repair Kit

- Ideal for repairs on PC's
- Contains 12 anti-static chip tools, protects chips from ESD damage
- Tools fit securely in a convenient roll-up pouch



Cat No.	UPC No.	Packed	Inch	mm	Description	Shelf Pack
99SPC	037103490940	Boxed	-	-	Complete kit	1
99820	037103483461	-	-	-	#0 Phillips screwdriver blade	6
99821	037103483485	-	-	-	#1 Phillips screwdriver blade	6
99811	037103483447	-	3/16	5	Slotted screwdriver blade	6
9910XTD	037103490025	-	-	-	Torx® screwdriver blade	6
9915XTD	037103490032	-	-	-	Torx® screwdriver blade	6
996	037103482693	-	3/16	5	Hex nutdriver shank	6
998	037103482747	-	1/4	6	Hex nutdriver shank	6
991	037103482532	-	-	-	Regular handle	6
					Three-prong chip retriever/ extractor – antistatic	-
					Chip tweezer, Chip inserter, Chip extractor – antistatic	-

99MP & 99MPX Multi-purpose Tool Kit



99MP

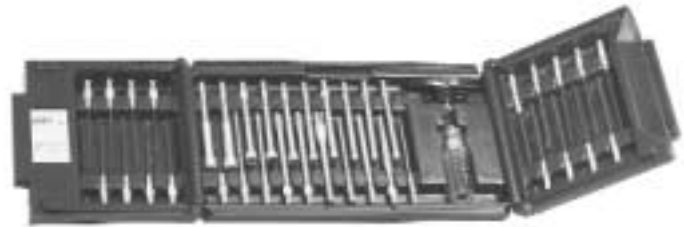

99MPX

- 39-piece kit contains most popular Series 99® tools
- 2 extra pockets permit addition of pliers, snips or other tools
- Available in a durable, roll-up plastic coated canvas case, or hard plastic case, for easy selection and storage

Cat No.	UPC No.	Packed	Inch	mm	Description	Shelf Pack
99MP	037103482235	Boxed	-	-	Complete kit	1
99MPK	037103482242	Boxed	-	-	Canvas case	1
99MPX	037103490261	Boxed	-	-	Complete kit w/carrying case	1
991	037103482532	-	-	-	Regular handle	6
994	037103482600	-	-	-	Tee handle	6
998M	037103482754	-	-	-	Magnetic nutdriver	6
996, to 9916	-	-	-	-	Regular nutdrivers (9)	-
9920, to 9926	-	-	-	-	Allen hex screwdrivers (9)	-
99764, 99964	-	-	-	-	-	-
9961, to 9969	-	-	-	-	Bristol multiple spline screwdrivers (9)	-
99125, 99811	-	-	-	-	Slotted screwdrivers	-
99250, 99312	-	-	-	-	-	-
99820, 99821, 99822	-	-	-	-	Phillips screwdrivers	-
9938	037103483126	-	-	-	Reamer	6
99X5	037103482501	-	-	-	Extension	6

99SL Scrulox Screwdriver Kit

- 6-piece kit
- Plastic view case
- Convenient hang-up hole



Cat No.	UPC No.	Packed	Inch	mm	Description	Shelf Pack
99SL	037103482426	Boxed	-	-	Complete kit	1
991	037103482532	-	-	-	Regular handle	6
99SL1, 2, 3	-	-	-	-	Scrulox screwdrivers	-
99250	037103483393	-	-	-	Slotted screwdriver	6

99PA50 Tool Kit

- Series 99® screwdriver and nutdriver set designed for use with cordless rechargeable screwdrivers
- Contains 12 most popular nutdriver and screwdriver sizes together with a power adapter (Xcelite® Catalog No. 99PA)
- Convenient vinyl carrying pouch



Cat No.	UPC No.	Packed	Description	Diameter Inch	Shelf Pack
99PA50	037103497299	Boxed	Complete set	3/16	6
99S7	037103095046	-	Stubby nutdriver	7/32	6
99S8	037103482396	-	Stubby nutdriver	1/4	6
99S9	037103095053	-	Stubby nutdriver	9/32	6
99S10	037103482402	-	Stubby nutdriver	5/16	6
Δ 99S11	037103095060	-	Stubby nutdriver	11/32	6
99S12	037103482419	-	Stubby nutdriver	3/8	6
99S811	037103095077	-	Stubby slotted screwdriver	3/16	6
99S250	037103095084	-	Stubby slotted screwdriver	1/4	6
99S821	037103095091	-	Stubby Phillips screwdriver	#1	6
99S822	037103095107	-	Stubby Phillips screwdriver	#2	6
99PA	037103490926	-	Cordless screwdriver adapter	-	6

Δ = Made to order, contact customer service for delivery.

Series 99® Compact Interchangeable-blade Sets

99PS40BP Ballpoint Allen hex socket type screwdriver set - Inch sizes

- Unique “ballpoint” tip ideal for tightening and removing Allen socket screws in hard to reach spots or need a quicker way to drive them home
- 9 blades 4"/101.60mm long, 99X5 extension and regular 991 handle in plastic see-through stand-up case
- Will engage screw head from any angle
- Ends precision-machined to close tolerances to help slip easily into sockets and hold securely without reaming

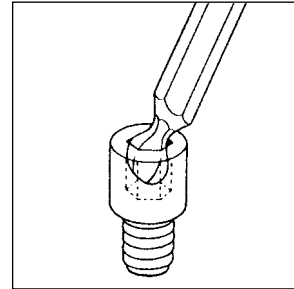

Cat No.	UPC No.	Packed	Tip Size Inch	Tool Length		Shelf Pack
				Inch	mm	
99PS40BP	037103482297	Boxed	Complete set	-	-	3
99PS40BPV	037103482303	Carded	Complete set carded	-	-	3
9920BP	037103482976	-	.050	4	102	6
9921BP	037103482990	-	1/16	4	102	6
9922BP	037103483010	-	5/64	4	102	6
9923BP	037103483034	-	3/32	4	102	6
99764BP	037103483430	-	7/64	4	102	6
9924BP	037103483058	-	1/8	4	102	6
99964BP	037103483553	-	9/64	4	102	6
9925BP	037103483072	-	5/32	4	102	0
9926BP	037103483096	-	3/16	4	102	6
991	037103482532	-	Regular handle	4	102	6
99X5	037103482501	-	Extension	4	102	6

99PS41MMBP Ballpoint Allen Hex Socket Type Screwdriver Set

Metric Sizes

- Interchangeable, Allen hex socket type
- Contains 7 drivers, 102mm 99X5 extension and regular 991 handle
- 102mm approximate working length
- Flexible plastic see-through stand-up case

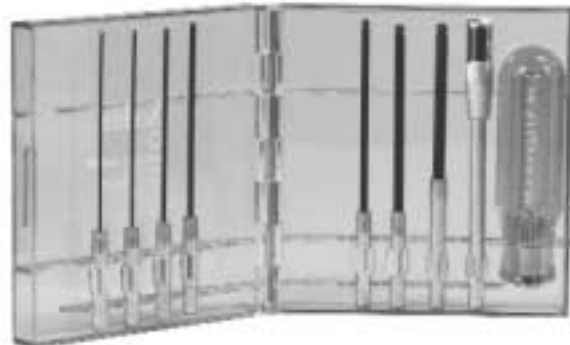

Cat No.	UPC No.	Packed	Description	Tool Length		Shelf Pack
				Inch	mm	
99PS41MMBP	037103482327	Boxed	Complete set	-	-	3
99PS41MMBPV	037103490605	Carded	Complete set carded	-	-	3
991	037103482532	-	Regular handle	4	102	6
99X5	037103482501	-	Extension	4	102	6

99XTD7 Torx® Screwdriver Blade Kit

- Interchangeable blades
- Contains 6 blades 4"/102mm long and regular 991 handle
- 102mm approximate working length



Cat No.	UPC No.	Packed	Tip Size	Tool Length		Shelf Pack
				Inch	mm	
99XTD7	037103490018	Boxed	Complete set	-	-	6
9910XTD	037103490025	-	T-10	4	102	6
9915XTD	037103490032	-	T-15	4	102	6
9920XTD	037103490049	-	T-20	4	102	6
9925XTD	037103490056	-	T-25	4	102	6
9927XTD	037103490063	-	T-27	4	102	6
9930XTD	037103490070	-	T-30	4	102	6
991	037103482532	-	Regular Handle	-	-	6

99PS40 Allen Hex Socket Type Screwdriver Set

Inch Sizes

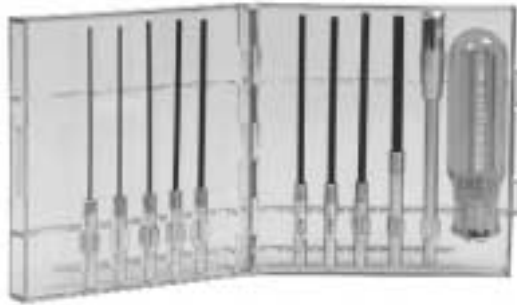

- 11-piece set
- See-through plastic case

Cat No.	UPC No.	Packed	Diameter Inch	Tool Length		Shelf Pack
				Inch	mm	
99PS40	037103482273	Boxed	Complete set	-	-	3
99PS40V	037103482280	Carded	Complete set carded	-	-	3
991	037103482532	-	Regular handle	-	-	6
9920	037103482969	-	.050	4	102	6
9921	037103482983	-	1/16	4	102	6
9922	037103483003	-	5/64	4	102	6
9923	037103483027	-	3/32	4	102	6
99764	037103483102	-	7/64	4	102	6
9924	037103483041	-	1/8	4	102	6
99964	037103483119	-	9/64	4	102	6
9925	037103483065	-	5/32	4	102	6
9926	037103483089	-	3/16	4	102	6
99X5	037103482501	-	Extension	4	102	6

99PS41MM Allen Hex Socket Type Screwdriver Set

Metric Sizes



- Compact interchangeable blades
- Fits socket screws shown below
- 99X5 extension adds 102mm in length
- 991 handle 27mm x 105mm in length
- 102mm approximate working length
- Convenient see-through stand-up plastic case

Cat No.	UPC No.	Packed	Diameter mm	Socket head cap screws		Diameter mm	Shelf Pack
				Set screws mm	Flat head cap screws thread diameter mm		
99PS41MM	037103482310	Boxed	Complete set	-	-	-	3
99PS41MMV	037103490599	Carded	Complete set carded	-	-	-	3
9971MM	037103483232	-	1.27	2.6	1.4	-	6
9972MM	037103483249	-	1.5	3	1.7, 2	-	6
9973MM	037103483256	-	2	4	2.3, 2.6	3	6
9974MM	037103483263	-	2.5	5	3	4	6
9975MM	037103483270	-	3	6	4	5	6
9976MM	037103483287	-	4	8	5	6	6
9977MM	037103483294	-	5	10	6	8	6
991	037103482532	-	-	Regular handle	-	-	6
99X5	037103482501	-	-	Extension	-	-	6

99PS50 Screwdriver and Nutdriver Set

- 13-piece set
- See-through stand-up plastic case

Inch Sizes

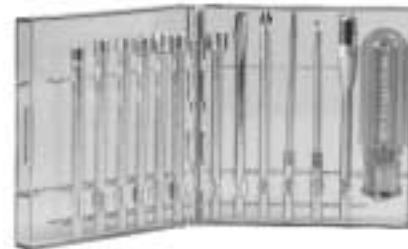

Cat No.	UPC No.	Packed	Description	Blade Diameter		Tool Length		Shelf Pack
				Inch		Inch	mm	
99PS50	037103482334	Boxed	Complete set	-		-		3
99PS50V	037103482341	Carded	Complete set carded	-		-		3
996	037103482693	-	Regular nutdriver	3/16		3 5/8	92	6
997	037103482716	-	Regular nutdriver	7/32		3 5/8	92	6
998	037103482747	-	Regular nutdriver	1/4		3 5/8	92	6
999	037103482792	-	Regular nutdriver	9/32		3 5/8	92	6
9910	037103482822	-	Regular nutdriver	5/16		3 5/8	92	6
9911	037103482853	-	Regular nutdriver	11/32		3 5/8	92	6
9912	037103482884	-	Regular nutdriver	3/8		3 5/8	92	6
99811	037103483447	-	Slotted screwdriver	3/16		3 7/8	98	6
99250	037103483393	-	Slotted screwdriver	1/4		3 7/8	98	6
99821	037103483485	-	Phillips screwdriver	No. 1		4	102	6
99822	037103483508	-	Phillips screwdriver	No. 2		4	102	6
99X5	037103482501	-	Extension	-		4	102	6
991	037103482532	-	Regular handle	-		4	102	6

9PS51MM Compact, Interchangeable Shank, Nutdriver Set

- 12-piece set
- Convenient see-through stand-up plastic case

Metric Sizes

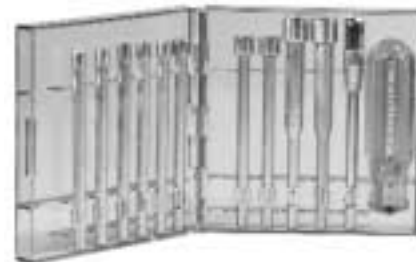

Cat No.	UPC No.	Packed	Approx. working Diameter mm	Hex head cap screws		Diameter mm	Shelf Pack
				Hex nuts thread diameter mm	thread length mm		
99PS51MM	037103482358	Boxed	Complete set	-		-	3
99PS51MMV	037103482365	Carded	Complete set carded	-		-	3
994MM	037103482617	-	4		92	2	6
9945MM	037103482624	-	4.5		92	2.3	6
995MM	037103482662	-	5		92	2.6	6
9955MM	037103482679	-	5.5		92	3	6
996MM	037103482686	-	6		92	3.5	6
997MM	037103482723	-	7		92	4	6
998MM	037103482761	-	8		92	5	6
999MM	037103482808	-	9		92	-	6
9910MM	037103482839	-	10		102	6	6
9911MM	037103482860	-	11		102	7	6
991	037103482532	-	Regular handle		102	-	6
99X5	037103482501	-	Extension		102	-	6

99PS60 Bristol Multiple-spline Socket Type Screwdriver Set

Inch Sizes



- 11-piece set
- Convenient see-through stand-up plastic case

Cat No.	UPC No.	Packed	Diameter mm	Tool Length		Shelf Pack
				Inch	mm	
99PS60	037103482372	Boxed	Complete set	-	-	3
99PS60V	037103482389	Carded	Complete set carded	-	-	3
9961	037103483140	-	.048	4	102	6
9962	037103483157	-	.060	4	102	6
9963	037103483164	-	.069	4	102	6
9964	037103483171	-	.072	4	102	6
9965	037103483188	-	.076	4	102	6
9966	037103483195	-	.096	4	102	6
9967	037103483201	-	.111	4	102	6
9968	037103483218	-	.145	4	102	6
9969	037103483225	-	.183	4	102	6
991	037103482532	-	Regular handle	4	102	6
99X5	037103482501	-	Extension	4	102	6

Electronic Assembly Tools Plier Selection Information

General

When selecting electronic cutting pliers, you should attempt to minimize your cost per cut by selecting the proper tool for each application. The type of cut, cutting area access, cutting edge quality and user preference will influence your choice.

Type of Cut

Electronic pliers are available with cutting edge angles that produce standard, semi-flush and flush cuts. These terms refer to the amount of "pinch" left on the tip of a wire after it has been cut

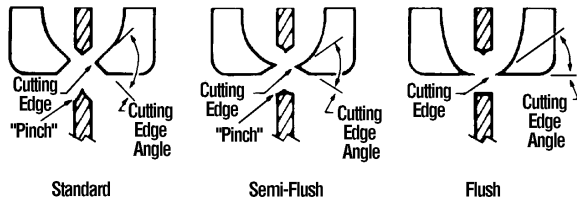

Standard cutting edges should be used for applications that are not sensitive to either the amount of shock transmitted through the wire to the component (during cutting) or to the amount of "pinch" left on the wire tip (after cutting).

Semi-flush edges can be employed for most applications. They reduce shock transmittal and wire tip "pinch."

Flush edges should be selected only for delicate applications, which require minimal shock transmittal and wire tip "pinch." Flush cutters produce a clean cut, which facilitates soldering and increases connection reliability. With small cutting edge angles, the life of flush cutters is substantially less than that of semi-flush cutters. The larger the cutting edge angle, the more cuts you can expect from the tool. For electronic assembly work, the semi-flush cutter is often the most cost-effective choice.

Cutting Area Access

Access to cutting areas can determine the shape and thickness of the cutting head. Tight clearances around the cutting area, the need to reach over in-place components or to work from directly above, and visibility requirements are all factors which will affect your choice of a tool. However, it is important to recognize that head shape and thickness are directly related to cutting edge life



Head Shape

Always select a cutter with the largest head that will meet your particular cutting requirements. It is a proven fact that more material behind the cutting edges gives more cuts and longer life.

Oval head cutters are the most versatile. They have the most material behind the cutting edges, and last longest. Tapered and angled head cutters should be selected only when access to the cutting area is limited. These cutters have less head mass, and provide proportionally fewer cuts.

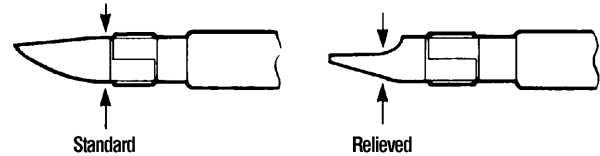

Head Thickness

Head thickness is related to cutting life in the same way as head shape. Cutting pliers with thicker heads also last longer. Whenever possible, use pliers with standard head thickness. Relieved head designs should be chosen only to accommodate difficult access problems.

Cutting Edge Quality

The quality of a pair of cutting pliers can be determined by visual inspection. The blades should meet smoothly and evenly at the tips. From a point just behind the tips to the joint, an increasing amount of light should be visible



A precision tip interface assures clean cutting of fine wires, while the "no contact" area behind the tips extends cutter life by allowing the tips to continue to meet as they wear.

User Preference

Other considerations can be a matter of personal preference. Handle shape, grip color, grip material, spring tension and leverage ratio are usually related to user comfort.

Proper spring tension will allow pliers to open and close with minimum effort. Finally, pliers with high leverage ratios provide the greatest ease of use and the longest life.

Leverage Ratio

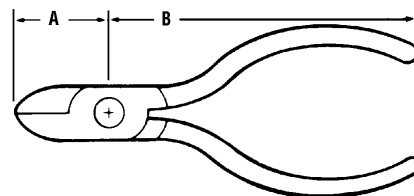

Leverage ratio is obtained by dividing dimension A into dimension B.

Cutting capability guide

* Maximum Tensile Strength

Catalog Number	Flush Edge	Semi-Flush Edge	Standard Edge	36 Ga. (.005) Teflon Coated Copper Wire	25 Ga. (.017) Soft Copper Wire	22 Ga. (.025) Soft Copper Wire	20 Ga. (.034) *90,000 PSI Steel Wire	20 Ga. (.034) *120,000 PSI Steel Wire	18 Ga. (.047) *200,000 PSI Steel Wire
EC54J	•				•	•	•		
EGA54J	•				•	•	•		
EMS543J	•				•	•	•		
EMS549J	•				•	•	•		
EMS54		•				•		•	
GA54J	•				•	•	•		
LC665J	•				•	•	•		
MS54			•				•		•
MS543J	•				•	•	•		
MS545		•				•		•	
MS545J	•				•	•	•		
MS549J	•				•	•	•		
S1415JS	•				•	•	•		
S424JS	•				•	•	•		
S54				•			•		•
S54KS		•				•		•	
S54S			•			•			•
S55				•			•		•
S55KS		•				•		•	
S55S			•			•			•
SN54			•				•		•
SN55			•				•		•
TC55			•				•		•

Xcelite® Electronic Pliers

Provide the ultimate in precision plier

- Manufactured to the highest professional quality
- Easily handles a wide range of electronic assembly requirements
- Smooth, easy-working, corrosion-proof joint
- Maintains perfect cutting edge and tip alignment
- All Xcelite® cutters and pliers are standard with ESD safe cushion grip handles. Exception: red grip products

Xcelite® Diagonal Cutting Pliers

FLUSH OR SEMI-FLUSH CUTTING EDGES HANDLE MOST CUTTING REQUIREMENTS

CUTTING EDGES MACHINE GROUND AND ELECTRONICALLY HARDENED FOR EXTENDED LIFE

FORGED ALLOY STEEL WITH POLISHED HEAD FOR HIGH DURABILITY

STEEL RIVIT FOR SMOOTH OPERATION AND LONG LIFE

HANDLE COIL SPRINGS FOR FAST CUTTING ACTION (Standard on all Models)

ESD SAFE CUSHION GRIPS FOR MAXIMUM COMFORT (Standard on all Models)

"ACCU-LITE" GRIPS ALSO AVAILABLE ON MANY MODELS

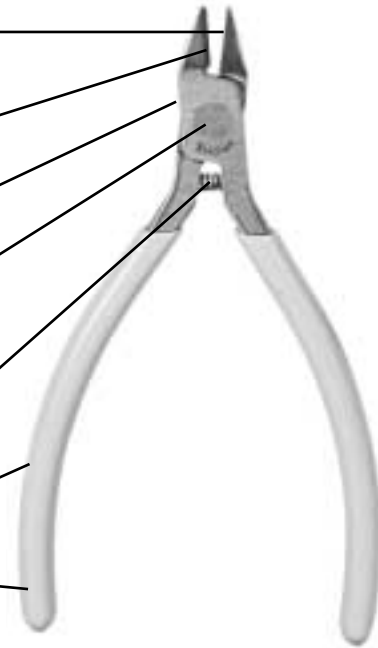

Pliers Features and Benefits

- Lightweight, miniature plier line. Includes versatile selection of diagonal, angular, tip and end cutters plus wiring and assembly tools.
- Choice of oval, tapered, relieved and angled head designs for general or confined area cutting.
- Full flush or semi-flush cutting edges machine ground and electronically hardened for extended life in cutting either hard or soft wires.
- Needle nose styles include long, short, curved, flat and round to handle most forming, looping, twisting, insertion and pickup jobs.
- Copaloy joint maintains perfect cutting edge and tip alignment to maximize operational consistency and tool life.
- Handle coil springs, standard on all Copaloy pliers, allow faster cutting action with reduced user fatigue.
- Forged from high quality alloy steel for maximum strength and durability.
- Precision ground to close tolerances, individually finished and tested to ensure exact fit of jaws.
- Polished heads with gun metal handles.
- Made in U.S.A.



CAUTION

1. Always wear approved eye protection.
2. Cushioned handles are not intended to provide protection against electric shock. Do not use on or near energized circuits.
3. When cutting wire or metal, hold short end to prevent flying pieces.



Accu-Lite Handles Meet The Optimum Criteria For Hand Tools:

THUMB FLAIR INCREASES TOOL CONTROL

EXCLUSIVE, SOFT, NON-SLIP FOAM GRIPS PROVIDE POSITIVE GRIPPING AND MAXIMUM COMFORT

IDENTICALLY FORMED HANDLES ALLOW EITHER RIGHT OR LEFT-HAND USE

ANTI-STATIC GRIP MATERIAL DISSIPATES STATIC CHARGES

SOIL RESISTANT SURFACE EXTENDS GRIP LIFE

CONCAVE CONFIGURATION DISPERSES GRIPPING PRESSURE

EXTENDED HANDLE PERMITS USE OF ALL FINGERS

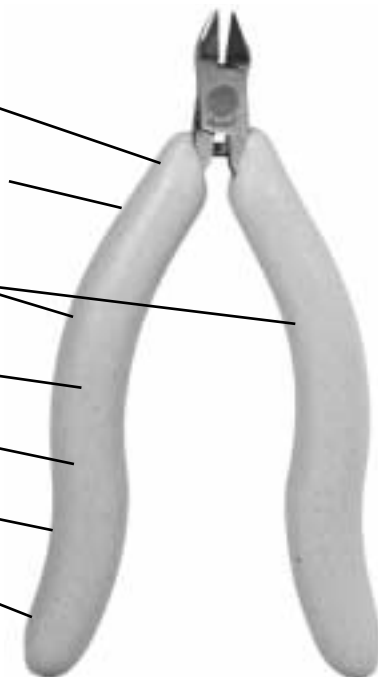

- **Lightweight construction**
- **Extended handle length** allows even application of force from all four fingers.
- **Exclusive, smooth, soft foam cushion grips** are free of abrupt edges and finger indentations.
- **Grip material is non-slip and compressible** to allow positive gripping and to absorb mechanical shock.
- **Handle contours adaptable for either right or left-hand use.**



Oval Head Cutter - Semi-flush

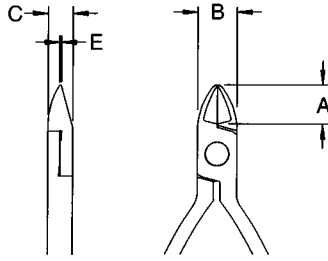

- Diagonal cutting pliers/semi-flush
- General-purpose cutting
- Oval head for long life
- Features green cushion grips

Cat No.	UPC No.	Packed	Length		A		B		C		E		Pack Wt.		Shelf Pack
			Inch	mm	Inch	mm	Inch	mm	Inch	mm	Inch	mm	lb	g	
MS54	043127069451	Bagged	4	100	13/32	10	7/16	11	9/32	7	1/32	.8	.78	354	6
MS54V	043127085444	Carded	4	100	13/32	10	7/16	11	9/32	7	1/32	.8	.78	354	6

Oval Head Cutter - Flush

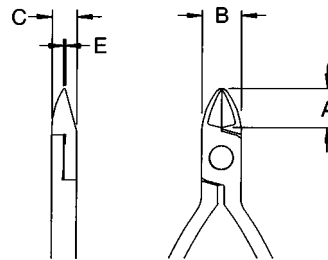

- Oval head diagonal cutter
- Flush cutting
- General use
- Features green cushion grips

Cat No.	UPC No.	Packed	Length		A		B		C		E		Pack Wt.		Shelf Pack
			Inch	mm	Inch	mm	Inch	mm	Inch	mm	Inch	mm	lb	g	
MS54J	043127160448	Bagged	4	100	13/32	10	7/16	11	9/32	7	1/32	.8	1.11	504	6

Tapered Head Diagonal Cutter

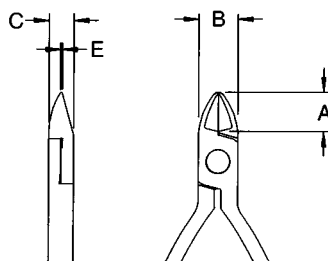

- Tapered head diagonal cutter
- Flush cutting of leads in restricted spaces
- Narrow tips give increased clearance
- Features green cushion grips
- Suffix "W" indicates wire catcher

Cat No.	UPC No.	Packed	Length		A		B		C		E		Pack Wt.		Shelf Pack
			Inch	mm	Inch	mm	Inch	mm	Inch	mm	Inch	mm	lb	g	
MS549J	043127170508	Bagged	4	100	15/32	12	7/16	11	9/32	7	3/64	1	.96	435	6
MS549JV	043127085420	Carded	4	100	15/32	12	7/16	11	9/32	7	3/64	1	.96	435	6
MS549JW	043127170539	Bagged	4	100	15/32	12	7/16	11	9/32	7	3/64	1	.96	435	6

Oval Head Diagonal Cutter

- Oval head diagonal cutter
- Semi-flush cutting
- General-purpose cutting of steel wires
- **Accu-Lite handles (see page 443)**

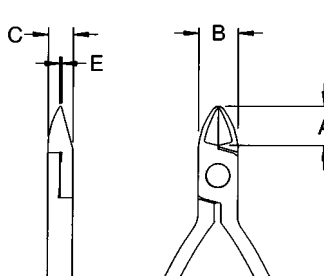

Cat No.	UPC No.	Packed	Length		A		B		C		E		Pack Wt.		Shelf Pack
			Inch	mm	Inch	mm	Inch	mm	Inch	mm	Inch	mm	lb	g	
EMS54	043127104374	Bagged	5 1/2	138	13/32	10	7/16	11	9/32	7	1/32	.8	.96	435	6

Tapered Head Diagonal Cutter

- Tapered head diagonal cutter
- Flush cutting
- **Accu-Lite handles (see page 443)**

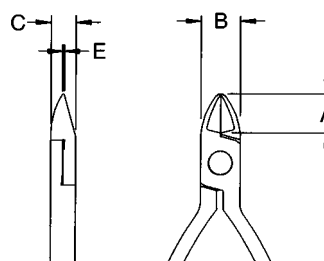

Cat No.	UPC No.	Packed	Length		A		B		C		E		Pack Wt.		Shelf Pack
			Inch	mm	Inch	mm	Inch	mm	Inch	mm	Inch	mm	lb	g	
EMS549J	043127104343	Bagged	5 1/2	138	15/32	12	7/16	11	9/32	7	3/64	1	.78	354	6

Relieved Tapered Head Cutter

- Diagonal cutting pliers
- Relieved tapered head-flush cutter
- Allows use between closely spaced components
- Features green cushion grips

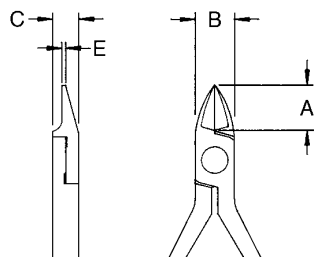

Cat No.	UPC No.	Packed	Length		A		B		C		E		Pack Wt.		Shelf Pack
			Inch	mm	Inch	mm	Inch	mm	Inch	mm	Inch	mm	lb	g	
MS543J	043127170676	Bagged	4	100	15/32	12	7/16	11	9/32	7	3/64	1	.78	354	6
MS543JV	037103129086	Carded	4	100	15/32	12	7/16	11	9/32	7	3/64	1	.78	354	6

Relieved Tapered Head Diagonal Cutter

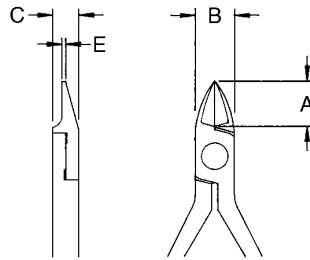

- Relieved tapered head diagonal cutter
- Flush cutting
- Clears closely spaced components
- **Accu-Lite handles (see page 443)**

Cat No.	UPC No.	Packed	Length		A		B		C		E		Pack Wt.		Shelf Pack
			Inch	mm	Inch	mm	Inch	mm	Inch	mm	Inch	mm	lb	g	
EMS543J	043127104329	Bagged	5 1/2	138	15/32	12	7/16	11	9/32	7	3/64	1	.78	354	6

Slim Line Tapered Head Cutter

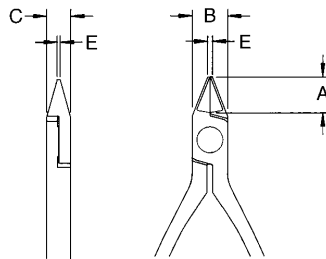

- Diagonal cutting pliers
- Slim line tapered head
- Semi-flush cutting
- Features green cushion grip

Cat No.	UPC No.	Packed	Length		A		B		C		E		Pack Wt.		Shelf Pack
			Inch	mm	Inch	mm	Inch	mm	Inch	mm	Inch	mm	lb	g	
MS545	043127069482	Bagged	4	100	13/32	10	7/16	11	9/32	7	1/16 x 1/32	1.5 x .9	.78	354	6
MS545V	037103129116	Carded	4	100	13/32	10	7/16	11	9/32	7	1/16 x 1/32	1.5 x .9	.96	435	6

Slim Line Tapered Head Cutter

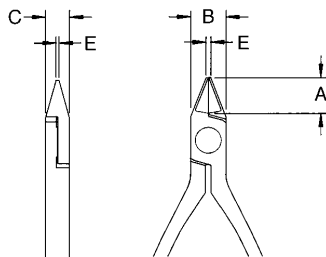

- Diagonal cutting pliers
- Slim line tapered head
- Flush cutting
- Features green cushion grips

Cat No.	UPC No.	Packed	Length		A		B		C		E		Pack Wt.		Shelf Pack
			Inch	mm	Inch	mm	Inch	mm	Inch	mm	Inch	mm	lb	g	
MS545J	043127170713	Bagged	4	100	13/32	10	7/16	11	9/32	7	1/16 x 1/32	1.5 x .9	1.01	458	6
MS545JV	043127086038	Carded	4	100	13/32	10	7/16	11	9/32	7	1/16 x 1/32	1.5 x .9	1.01	458	6

Slim Line Tapered Diagonal Cutter

- Slim line tapered diagonal cutter
- Flush cutting
- Allows use between closely spaced components
- **Accu-Lite handles (see page 443)**

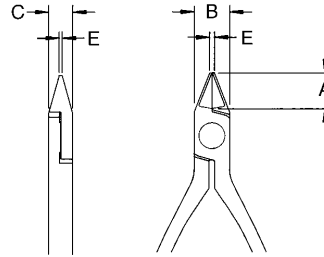

Cat No.	UPC No.	Packed	Length		A		B		C		E		Pack Wt.		Shelf Pack
			Inch	mm	Inch	mm	Inch	mm	Inch	mm	Inch	mm	lb	g	
EMS545J	043127104336	Bagged	5 1/2	138	13/32	10	7/16	11	9/32	7	1/32	.8	.78	354	6

Relieved Head Diagonal Cutter

- Relieved tapered head diagonal cutter
- Flush cutting
- For use in limited access areas
- Features green cushion grips

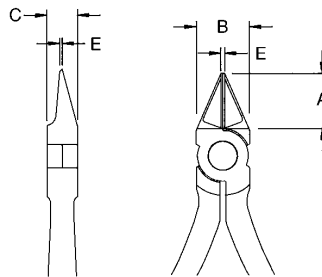

Cat No.	UPC No.	Packed	Length		A		B		C		E		Pack Wt.		Shelf Pack
			Inch	mm	Inch	mm	Inch	mm	Inch	mm	Inch	mm	lb	g	
S424JS	043127062704	Bagged	4	100	5/8	16	37/64	15	5/16	8	3/64 x 1/32	1 x .8	1.33	603	6
S424JSV	043127128691	Carded	4	100	5/8	16	37/64	15	5/16	8	3/64 x 1/32	1 x .8	1.33	603	6

Tapered Head Diagonal Cutter

- Tapered head diagonal cutter
- Flush cutting
- Used for cutting component leads
- Features green cushion grips

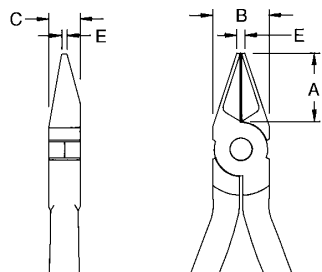

Cat No.	UPC No.	Packed	Length		A		B		C		E		Pack Wt.		Shelf Pack
			Inch	mm	Inch	mm	Inch	mm	Inch	mm	Inch	mm	lb	g	
S475JS	043127062933	Bagged	5	125	3/4	19	19/32	15	3/8	10	3/32 x 1/16	2 x 1.5	1.47	667	6
S475JSV	043127128714	Carded	5	125	3/4	19	19/32	15	3/8	10	3/32 x 1/16	2 x 1.5	1.47	667	6

Tapered Relieved Head Diagonal Cutter

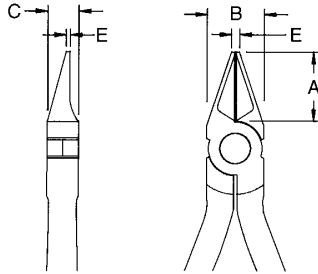

- Tapered relieved head diagonal cutter
- Flush cutting
- For use in limited access areas
- Features green cushion grips

Cat No.	UPC No.	Packed	Length		A		B		C		E		Pack Wt.		Shelf Pack
			Inch	mm	Inch	mm	Inch	mm	Inch	mm	Inch	mm	lb	g	
S1415JS	043127062926	Bagged	5	125	49/64	19	19/32	15	3/8	10	3/32 x 3/64	2 x 1	1.5	680	6

Diagonal Lead Cutter

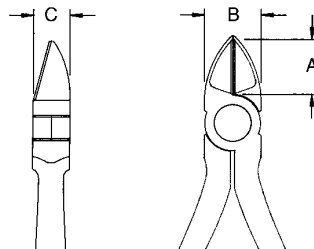

- Diagonal lead cutter
- Heavy-duty cutting
- Features green cushion grips
- S54S same as S54 plus handle coil spring

Cat No.	UPC No.	Packed	Length		A		B		C		Pack Wt.		Shelf Pack
			Inch	mm	Inch	mm	Inch	mm	Inch	mm	lb	g	
S54	043127130090	Bagged	4 1/2	112	5/8	16	37/64	15	3/8	9	1.32	599	6
S54S	043127130120	Bagged	4 1/2	112	5/8	16	37/64	15	3/8	9	1.32	599	6
S54SV	043127128721	Carded	4 1/2	112	5/8	16	37/64	15	3/8	9	1.32	599	6

Diagonal Lead Cutter

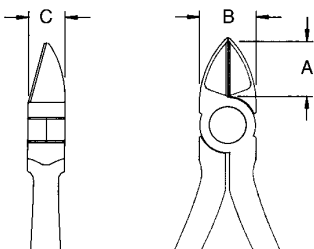

- Diagonal lead cutter with handle coil spring
- Heavy-duty cutting
- Semi-flush cutter
- Features green cushion grips

Cat No.	UPC No.	Packed	Length		A		B		C		Pack Wt.		Shelf Pack
			Inch	mm	Inch	mm	Inch	mm	lb	g			
S54KS	043127130144	Bagged	4 1/2	112	5/8	16	37/64	15	3/8	9	1.32	599	6

Oval Head Diagonal Cutter

- Oval head diagonal cutter
- Regular beveled edge
- Features green cushion grips
- S55S same as S55 plus handle coil spring

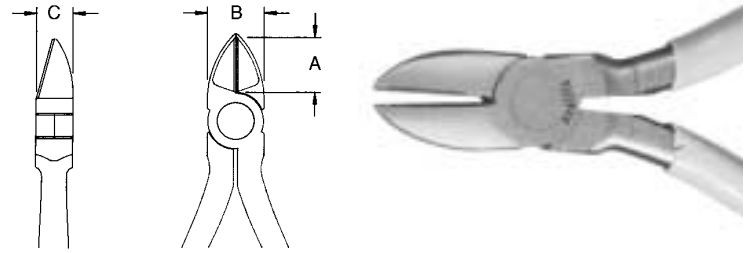

Cat No.	UPC No.	Packed	Length		A		B		C		Pack Wt.		Shelf Pack
			Inch	mm	Inch	mm	Inch	mm	Inch	mm	lb	g	
S55	043127130229	Bagged	5	125	49/64	19	19/32	15	3/8	9	1.5	680	6
S55S	043127130243	Bagged	5	125	49/64	19	19/32	15	3/8	9	1.5	680	6

Oval Head Diagonal Cutter

- Oval head diagonal cutter with handle coil spring
- Heavy-duty cutting
- Semi-flush cutter
- Features green cushion grips

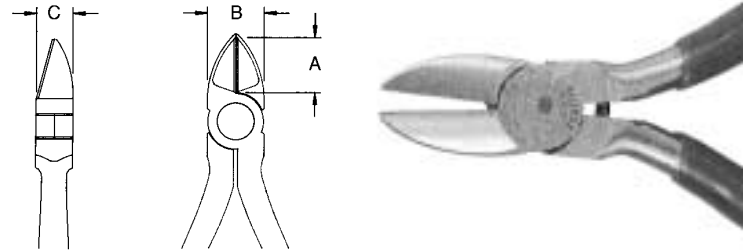

Cat No.	UPC No.	Packed	Length		A		B		C		Pack Wt.		Shelf Pack
			Inch	mm	Inch	mm	Inch	mm	Inch	mm	lb	g	
S55KS	043127130298	Bagged	5	125	49/64	19	19/32	15	3/8	9	1.5	680	6

Xcelite® Diagonal End Cutter Pliers

Angled Diagonal End Cutter at 29°

- Angled diagonal end cutter at 29°
- Flush cutting
- For cutting directly above the work area
- To use on closely spaced adjacent components
- Features green cushion grips

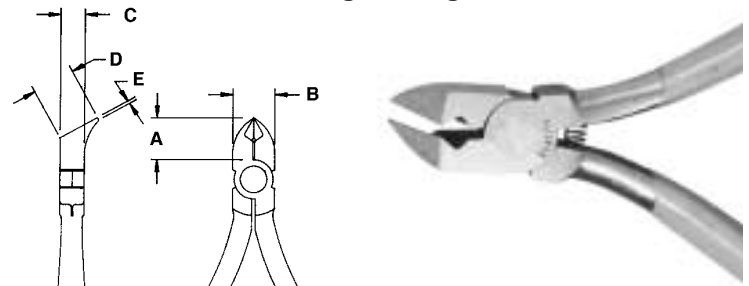

Cat No.	UPC No.	Packed	Length		A		B		C		D		E		Pack Wt.		Shelf Pack
			Inch	mm	Inch	mm	Inch	mm	Inch	mm	Inch	mm	lb	g			
GA54J	043127170331	Bagged	4	100	7/16	11	7/16	11	9/32	7	7/16	11	1/32	.8	.96	454	6
GA54JV	043127085475	Carded	4	100	7/16	11	7/16	11	9/32	7	7/16	11	1/32	.8	.96	454	6

Angled Head Cutter

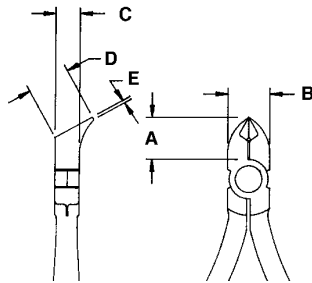

- Angled cutter
- Flush cutting edges
- Head angle allows cutting from above
- **Accu-Lite handles (see page 443)**

Cat No.	UPC No.	Packed	Length		A		B		C		D		E		Pack Wt.		Shelf Pack
			Inch	mm	Inch	mm	Inch	mm	Inch	mm	Inch	mm	Inch	mm	lb	g	
EGA54J	043127064197	Bagged	5 1/2	138	7/16	11	7/16	11	9/32	7	7/16	11	1/32	.8	.96	454	6

Transverse End Cutter

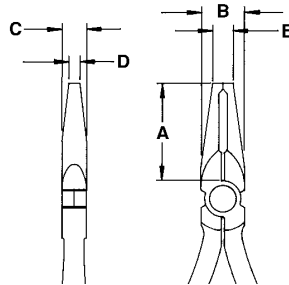

- Transverse end cutter
- Flush cutting edge
- Vertical cutting in tight spaces
- Features green cushion grips

Cat No.	UPC No.	Packed	Length		A		B		C		D		E		Pack Wt.		Shelf Pack
			Inch	mm	Inch	mm	Inch	mm	Inch	mm	Inch	mm	Inch	mm	lb	g	
EC54J	043127170096	Bagged	4 1/2	112	1	25	7/16	11	9/32	7	1/8	3	3/16	5	.78	354	6
EC54JV	037103129123	Carded	4 1/2	112	1	25	7/16	11	9/32	7	1/8	3	3/16	5	.78	354	6

Angled Tip Cutter

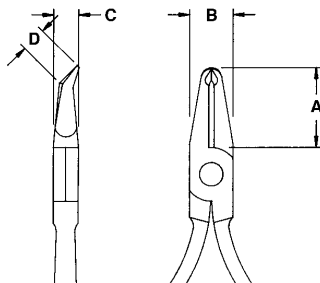

- Angled tip cutter
- Flush cutting in dense areas
- Thin angled nose for high visibility
- Features green cushion grips

Cat No.	UPC No.	Packed	Length		A		B		C		D		Pack Wt.		Shelf Pack
			Inch	mm	Inch	mm	Inch	mm	Inch	mm	Inch	mm	lb	g	
LC665J	043127062742	Bagged	4 1/2	112	29/32	23	1/2	13	19/64	7	1/4	6	.96	454	6
LC665JV	037103129192	Carded	4 1/2	112	29/32	23	1/2	13	19/64	7	1/4	6	.96	454	6

Diagonal Chain Nose Pliers - Short Chain Nose Pliers

- Short chain nose pliers
- Serrated jaws
- Heavy-duty
- Features green cushion grips

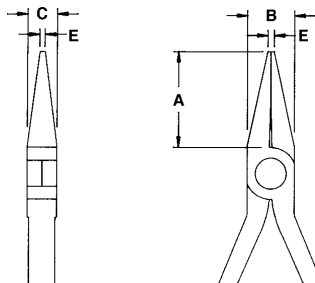

Cat No.	UPC No.	Packed	Length		A		B		C		E		Pack Wt.		Shelf Pack
			Inch	mm	Inch	mm	Inch	mm	Inch	mm	Inch	mm	lb	g	
LN225	043127063138	Bagged	5	125	1 9/64	29	17/32	14	9/32	7	1/16 x 1/16	1.5 x 1.5	1.14	517	6

60° Curved Nose Pliers

- Curved nose pliers
- Thin tip
- CN255, CN255G feature green cushion grips
- Features smooth jaws

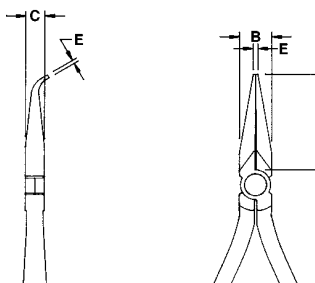

Cat No.	UPC No.	Packed	Length		A		B		C		E		Pack Wt.		Shelf Pack
			Inch	mm	Inch	mm	Inch	mm	Inch	mm	Inch	mm	lb	g	
CN255	043127063022	Bagged	5	125	1 15/64	31	27/64	11	9/32	7	3/64	1	.90	408	6
CN255V	037103129147	Carded	5	125	1 15/64	31	27/64	11	9/32	7	3/64	1	.90	408	6
CN255G	043127063091	Bagged	5	125	1 15/64	31	27/64	11	9/32	7	3/64	1	.90	408	6

Diagonal Long Needle Nose Pliers - Thin Long Nose Pliers

- Thin long nose pliers
- General-purpose use
- Serrated jaws
- For pick-up and wire forming
- Features green cushion grips
- LN54CS packaged on a clip strip merchandising wand

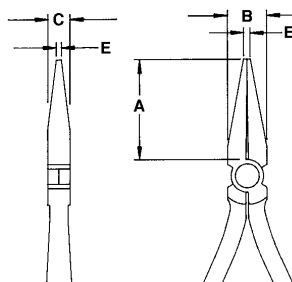

Cat No.	UPC No.	Packed	Length		A		B		C		E		Pack Wt.		Shelf Pack
			Inch	mm	Inch	mm	Inch	mm	Inch	mm	Inch	mm	lb	g	
LN54	043127170003	Bagged	5	125	1 3/16	30	7/16	11	9/32	7	5/64 x 1/16	2 x 1.6	.96	435	6
LN54V	043127085468	Carded	5	125	1 3/16	30	7/16	11	9/32	7	5/64 x 1/16	2 x 1.6	.96	435	6

Thin Long Nose Pliers - Fine Point

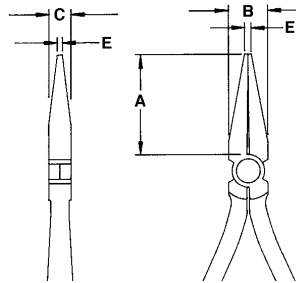

- Thin long nose pliers
- Fine point for precision work
- For pick-up and wire forming
- Serrated jaws
- Features green cushion grips

Cat No.	UPC No.	Packed	Length		A		B		C		E		Pack Wt.		Shelf Pack
			Inch	mm	Inch	mm	Inch	mm	Inch	mm	Inch	mm	lb	g	
LN542	043127170065	Bagged	5	125	1 3/16	30	7/16	11	9/32	7	3/64 x 1/32	1.2 x .8	.96	435	6

Thin Long Nose Pliers - Smooth Jaws

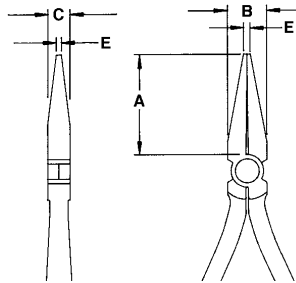

- Thin long nose pliers with smooth jaws
- General-purpose use
- For pick-up and wire forming
- Features green cushion grips

Cat No.	UPC No.	Packed	Length		A		B		C		E		Pack Wt.		Shelf Pack
			Inch	mm	Inch	mm	Inch	mm	Inch	mm	Inch	mm	lb	g	
LN54G	043127170027	Bagged	5	125	1 3/16	30	7/16	11	9/32	7	5/64 x 1/16	2 x 1.6	1.14	517	6
LN54GV	037103129154	Carded	5	125	1 3/16	30	7/16	11	9/32	7	5/64 x 1/16	2 x 1.6	1.14	517	6

Thin Long Nose Pliers

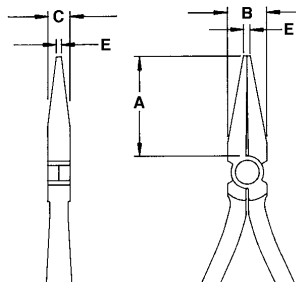

- Thin long nose pliers
- General-purpose use pick-up and wire forming
- ELN54 features fine serrated jaws
- ELN54G features smooth jaws
- **Accu-Lite handles (see page 443)**

Cat No.	UPC No.	Packed	Length		A		B		C		E		Pack Wt.		Shelf Pack
			Inch	mm	Inch	mm	Inch	mm	Inch	mm	Inch	mm	lb	g	
ELN54	043127170010	Bagged	6 1/2	163	1 3/16	30	7/16	11	9/32	7	5/64 x 1/16	2 x 1.6	.96	435	6
ELN54G	043127104350	Bagged	6 1/2	163	1 3/16	30	7/16	11	9/32	7	5/64 x 1/16	2 x 1.6	.96	435	6

Thin Long Nose Pliers

- Thin long nose pliers
- General-purpose
- Fine serrated jaws
- Features green cushion grips

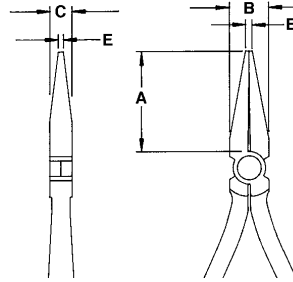

Cat No.	UPC No.	Packed	Length		A		B		C		E		Pack Wt.		Shelf Pack
			Inch	mm	Inch	mm	Inch	mm	Inch	mm	Inch	mm	lb	g	
LN55	043127068997	Bagged	5 1/2	138	1 11/16	43	17/32	14	9/32	7	5/64 x 1/16	2 x 1.6	1.5	680	6
LN55V	037103129161	Carded	5 1/2	138	1 11/16	43	17/32	14	9/32	7	5/64 x 1/16	2 x 1.6	1.5	680	6

Long Nose Side Cutting Pliers

- Long nose side cutting pliers
- For general wire applications
- For reaching into confined working spaces
- Serrated jaws
- Features green cushion grips
- SN55CS packaged on a clip strip merchandising wand

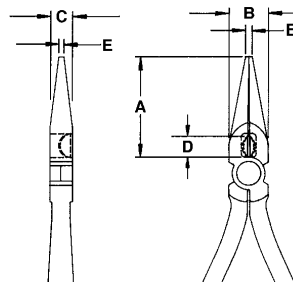

Cat No.	UPC No.	Packed	Length		A		B		C		D		E		Pack Wt.		Shelf Pack
			Inch	mm	Inch	mm	Inch	mm	Inch	mm	Inch	mm	Inch	mm	lb	g	
SN54	043127170225	Bagged	5	125	1 3/16	30	17/32	14	9/32	7	1/4	6	5/64 x 1/16	2 x 1.6	.96	435	6
SN55V	037103129185	Carded	5 1/2	138	1 11/16	43	17/32	14	9/32	7	3/8	10	5/64 x 1/16	2 x 1.6	1.32	599	6

Wiring Pliers with Tip Cutter

- Wiring pliers with tip cutter
- Long nose
- Features green cushion grips

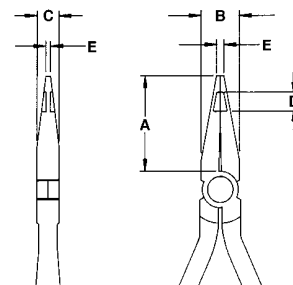

Cat No.	UPC No.	Packed	Length		A		B		C		D		E		Pack Wt.		Shelf Pack
			Inch	mm	Inch	mm	Inch	mm	Inch	mm	Inch	mm	Inch	mm	lb	g	
TC55	043127070587	Bagged	5 1/2	138	1 1/4	32	17/32	14	9/32	7	1/4	6.4	3/32 x 1/16	2.4 x 1.6	1.33	603	6

60° Curved Long Nose Pliers

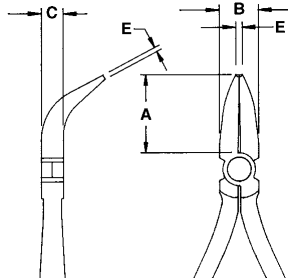

- 60° curved long nose pliers
- Smooth jaws
- For reaching between closely spaced components
- Features green cushion grips

Cat No.	UPC No.	Packed	Length		A		B		C		E		Pack Wt.		Shelf Pack
			Inch	mm	Inch	mm	Inch	mm	Inch	mm	Inch	mm	lb	g	
CN54G	043127170423	Bagged	5	125	15/16	24	7/16	11	9/32	7	5/64 x 1/16	2 x 1.6	1.14	517	6

45° Curved Long Nose Pliers

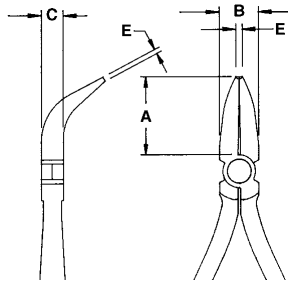

- 45° curved long nose pliers
- Smooth jaws
- For reaching over assembled components in confined areas
- Features green cushion grips

Cat No.	UPC No.	Packed	Length		A		B		C		E		Pack Wt.		Shelf Pack
			Inch	mm	Inch	mm	Inch	mm	Inch	mm	Inch	mm	lb	g	
CN55G	043127170140	Bagged	5 1/2	138	1 9/16	40	7/32	14	9/32	7	5/64 x 1/16	2 x 1.6	1.5	680	6

Round Nose Pliers

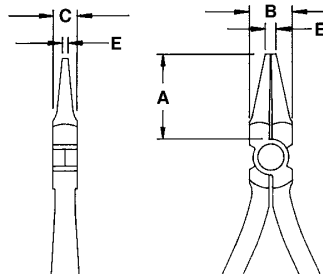

- Round nose pliers
- Round, smooth jaws tapered to point
- For looping and forming of fine wire
- Features green cushion grips

Cat No.	UPC No.	Packed	Length		A		B		C		E		Pack Wt.		Shelf Pack
			Inch	mm	Inch	mm	Inch	mm	Inch	mm	Inch	mm	lb	g	
RN54	043127170966	Bagged	4 1/2	113	7/8	22	7/16	11	9/32	7	1/8 x 1/16	3 x 1.6	.96	435	6

Flat Nose Pliers

- Flat nose pliers
- Smooth jaws
- For holding and forming wire and small parts
- Features green cushion grips

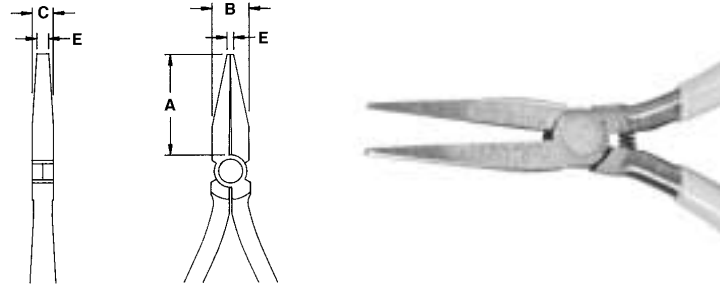

Cat No.	UPC No.	Packed	Length		A		B		C		E		Pack Wt.		Shelf Pack
			Inch	mm	Inch	mm	Inch	mm	Inch	mm	Inch	mm	lb	g	
DN54G	043127170461	Bagged	5	125	1 3/16	30	7/16	11	9/32	7	5/64 x 9/64	2 x 3.6	1.11	504	6
DN54GV	037103129093	Carded	5	125	1 3/16	30	7/16	11	9/32	7	5/64 x 9/64	2 x 3.6	1.11	504	6

Subminiature Needle Nose Pliers

- Subminiature needle nose pliers
- Positive gripping of fine wire or subminiature components
- Fine point allows use in confined areas
- L4 features serrated jaws
- L4G features smooth jaws
- Features green cushion grips
- L4CS packaged on a clip strip merchandising wand

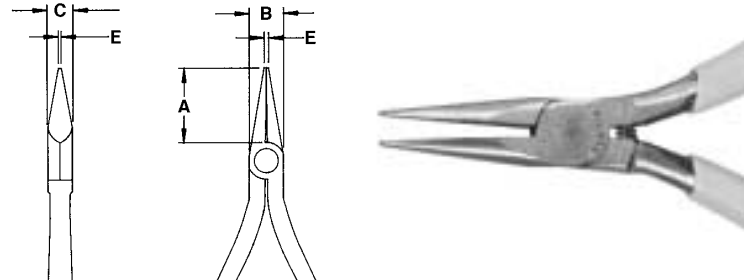

Cat No.	UPC No.	Packed	Length		A		B		C		E		Pack Wt.		Shelf Pack
			Inch	mm	Inch	mm	Inch	mm	Inch	mm	Inch	mm	lb	g	
L4	043127161049	Bagged	4	100	13/16	21	3/8	10	9/32	7	3/64 x 1/32	1.2 x .8	.78	354	6
L4V	043127085482	Carded	4	100	13/16	21	3/8	10	9/32	7	3/64 x 1/32	1.2 x .8	.78	354	6
L4G	043127161056	Bagged	4	100	13/16	21	3/8	10	9/32	7	3/64 x 1/32	1.2 x .8	.78	354	6

Flat Nose Wiring Pliers

- Flat nose wiring pliers
- Positions and holds small components
- For use in restricted access areas
- Features green cushion grips
- Serrated jaws

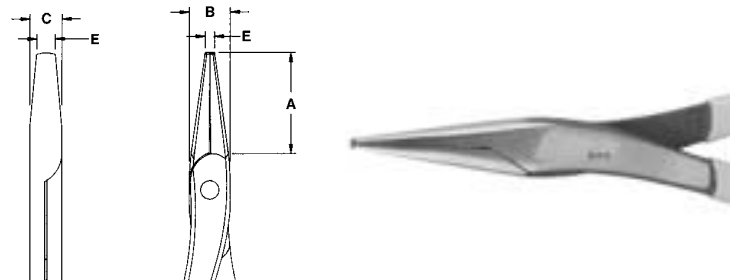

Cat No.	UPC No.	Packed	Length		A		B		C		E		Pack Wt.		Shelf Pack
			Inch	mm	Inch	mm	Inch	mm	Inch	mm	Inch	mm	lb	g	
318	043127063114	Bagged	8	200	1 3/8	35	17/32	14	7/16	11	1/8 x 1/4	3.2 x 6.4	2.46	1116	6

Needle Nose Assembly Pliers

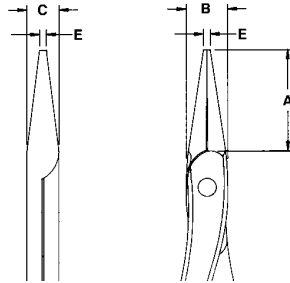

- Needle nose assembly pliers
- Reaches deep within electronic assemblies
- Use in hard to reach work spaces
- Features green cushion grips

Cat No.	UPC No.	Packed	Length		A		B		C		E		Pack Wt.		Shelf Pack
			Inch	mm	Inch	mm	Inch	mm	Inch	mm	Inch	mm	lb	g	
828	043127063107	Bagged	8	200	1 23/64	35	17/32	14	7/16	11	3/32dia.	2.4dia.	2.22	1007	6

Needle Nose Pliers Slim Line Needle Nose Pliers

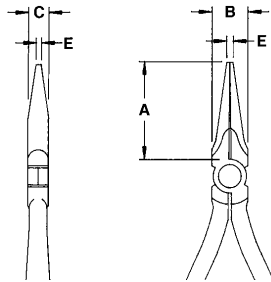

- Slim line needle nose pliers
- For use between tightly spaced components
- NN54, NN55, feature serrated jaws
- NN54G, NN55G feature smooth jaws
- Features green cushion grips

Cat No.	UPC No.	Packed	Length		A		B		C		E		Pack Wt.		Shelf Pack
			Inch	mm	Inch	mm	Inch	mm	Inch	mm	Inch	mm	lb	g	
NN54	043127170898	Bagged	5	125	1 3/16	30	7/16	11	9/32	7	5/64 x 1/16	2 x 1.6	.96	435	6
NN54V	043127089499	Carded	5	125	1 3/16	30	7/16	11	9/32	7	5/64 x 1/16	2 x 1.6	.96	435	6
NN54G	043127170911	Bagged	5	125	1 3/16	30	7/16	11	9/32	7	5/64 x 1/16	2 x 1.6	.96	435	6
NN54GV	037103129130	Carded	5	125	1 3/16	30	7/16	11	9/32	7	5/64 x 1/16	2 x 1.6	.96	435	6
NN55	043127170669	Bagged	5 1/2	138	1 11/16	43	15/32	12	1/4	6	5/64 x 1/16	2 x 1.6	1.32	5.99	6
NN55V	037103129468	Carded	5 1/2	138	1 11/16	43	15/32	12	1/4	6	5/64 x 1/16	2 x 1.6	1.32	5.99	6
NN55G	043127170935	Bagged	5 1/2	138	1 11/16	43	15/32	12	1/4	6	5/64 x 1/16	2 x 1.6	1.32	5.99	6

Fine Point Needle Nose Pliers

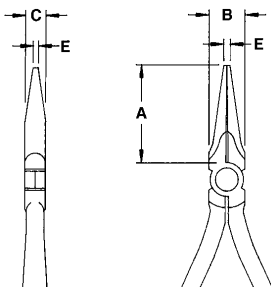

- Fine point needle nose pliers
- Positive gripping of fine wires or subminiature components
- Long, thin nose with fine serrated jaws
- Features green cushion grips

Cat No.	UPC No.	Packed	Length		A		B		C		E		Pack Wt.		Shelf Pack
			Inch	mm	Inch	mm	Inch	mm	Inch	mm	Inch	mm	lb	g	
NN542	043127170126	Bagged	5	125	1 3/16	30	7/16	11	9/32	7	3/64 x 1/32	1.2 x .8	.96	435	6

Fine Point Needle Nose Pliers

- Fine point needle nose pliers
- Positive gripping of fine wires or subminiature components
- Long, thin nose with fine serrated jaws
- Accu-Lite handles (see page 443)

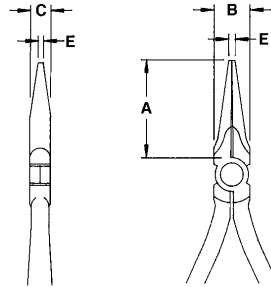

Cat No.	UPC No.	Packed	Length		A		B		C		E		Pack Wt.		Shelf Pack
			Inch	mm	Inch	mm	Inch	mm	Inch	mm	Inch	mm	lb	g	
ENN54	043127170904	Bagged	6 1/2	163	1 3/16	30	7/16	11	9/32	7	5/64 x 1/16	2 x 1.6	.96	435	6

Long Nose Wiring and Pick-up Pliers

- Wiring and pick-up pliers
- With alignment pin
- Long nose design
- Features green cushion grips

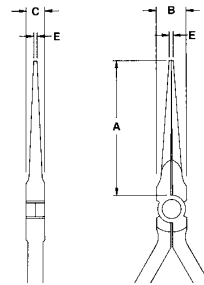

Cat No.	UPC No.	Packed	Length		A		B		C		E		Pack Wt.		Shelf Pack
			Inch	mm	Inch	mm	Inch	mm	Inch	mm	Inch	mm	lb	g	
LN774512	043127063077	Bagged	5 1/2	138	1 3/4	45	15/32	12	1/4	6	1/16 x 1/16	1.5 x 1.5	1.08	490	6
LN774512V	037103129475	Carded	5 1/2	138	1 3/4	45	15/32	12	1/4	6	1/16 x 1/16	1.5 x 1.5	1.08	490	6

Slim Line Long Needle Nose Pliers

- Slim line needle nose pliers
- Fine tip
- LN775512 features serrated jaws
- LN775512G features smooth jaws
- Features green cushion grips

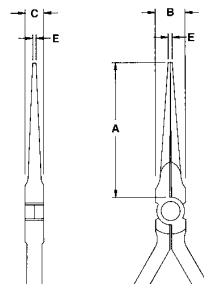

Cat No.	UPC No.	Packed	Length		A		B		C		E		Pack Wt.		Shelf Pack
			Inch	mm	Inch	mm	Inch	mm	Inch	mm	Inch	mm	lb	g	
LN775512	043127063121	Bagged	5 1/2	138	1 3/4	45	15/32	12	1/4	6	1/16 x 1/16	1.5 x 1.5	1.14	517	6
LN775512V	037103129499	Carded	5 1/2	138	1 3/4	45	15/32	12	1/4	6	1/16 x 1/16	1.5 x 1.5	1.14	517	6
LN775512G	043127079665	Bagged	5 1/2	138	1 3/4	45	15/32	12	1/4	6	1/16 x 1/16	1.5 x 1.5	1.14	517	6

60° Curved Long Nose Pliers

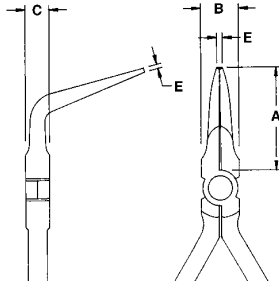

- Curved long nose pliers
- For reaching into confined spaces
- Features green cushion grips

Cat No.	UPC No.	Packed	Length		A		B		C		E		Pack Wt.		Shelf Pack
			Inch	mm	Inch	mm	Inch	mm	Inch	mm	Inch	mm	lb	g	
CN7776	043127063060	Bagged	6	150	1 23/64	35	15/32	12	1/4	6	1/16 x 1/16	1.5 x 1.5	1.35	612	6

Long Needle Nose Pliers

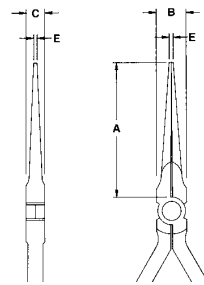

- Long needle nose pliers
- Extra long nose
- NN7776 features serrated jaws
- NN7776G features smooth jaws
- Features green cushion grips

Cat No.	UPC No.	Packed	Length		A		B		C		E		Pack Wt.		Shelf Pack
			Inch	mm	Inch	mm	Inch	mm	Inch	mm	Inch	mm	lb	g	
NN7776	043127063008	Bagged	6	150	2 5/16	59	15/32	12	1/4	6	1/16 x 1/16	1.5 x 1.5	1.32	599	6
NN7776V	037103129482	Carded	6	150	2 5/16	59	15/32	12	1/4	6	1/16 x 1/16	1.5 x 1.5	1.32	599	6
NN7776G	043127083297	Bagged	6	150	2 5/16	59	15/32	12	1/4	6	1/16 x 1/16	1.5 x 1.5	1.32	599	6

Pliers Kit - Electronics Handy Pack Assortment



- A compact kit designed for the sophisticated electronics technician or dedicated hobbyist
- Consists of the six most popular Copaloy electronics pliers
- Durable pocket-pouch with heavy-duty snaps
- Each professional quality tool features the unique Copaloy rivet for smoother action

Kit Includes:

- EC54J 4 1/2" Transverse end cutting pliers
- MS54 4" Diagonal cutting pliers
- SN54 5" Long nose pliers with side cutter
- NN54 5" Fine tip needle nose pliers
- DN54G 5" Flat nose pliers
- LN54 5" Long nose pliers
- Pocket pouch with snaps

Cat No.	UPC No.	Description	Pack Wt.		Shelf Pack
			lb	g	
C1K	043127880179	6 pc. pliers kit	1	.45	1

Electronic Shearcutters and Pliers

Superior Quality and Value

- Xcelite's Shearcutter flush cutting tools require less than half the operator force of most wire and lead cutting tools and transmit proportionately less shock to the component
- As a result, they comply with MIL-STD-2000, DOD-STD-2000 and WS-6536E standards
- Grips are molded of wide, shock absorbing material for operator comfort
- Models 175 and 2178 incorporate safety clips which effectively eliminate flying leads
- However, safety glasses are still recommended when using these tools

Shear Cut

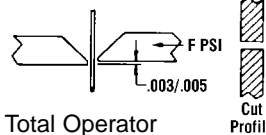

Total Operator

$$\text{Force} = \text{Less Than } 1/2 F$$

Crush Cut

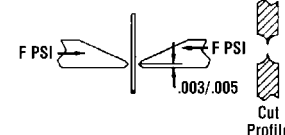

$$\text{Total Operator Force} = F$$

In shearcutting, one edge acts as an anvil while the other edge shears off the lead.



Shearcutter
170/175



Heavy-Duty
Shearcutter
1178/2178

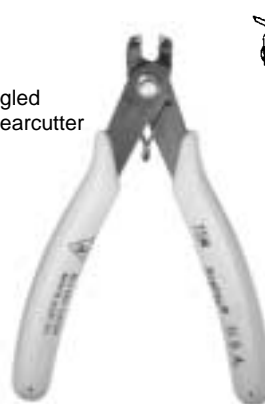

Angled
Shearcutter
75



Plier
378

Product features



Shearcutter — Light blue grips (Suffix "M")

- Advanced handle design
- Made from high quality carbon steel
- Non-glare black finish
- Superior shearing action



Static-dissipative pliers — black grips (Suffix "D")

- Advanced handle design
- Specially hardened and plated
- Non-glare black finish
- Superior shearing action



"ESD" Safe

Shearcutter - General-purpose

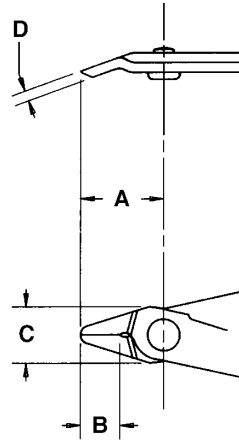

- Low profile, general-purpose cutter
- Superior blade by-pass shear cutting action
- Better cuts with half the effort
- Greatly reduced mechanical shock delivered to the work
- 170M, 175M feature light blue grips
- 170D, 175D feature static-dissapative black grips
- 175M, 175D feature safety clips
- 170D, 175D especially hardened and plated
- Flush cuts soft wire up to 20 AWG (0.8mm)
- 170MCS packaged on a clip strip merchandising wand

Safety Clip

Cat No.	UPC No.	Packed	Length		A		B		C		D		Pack Wt.		Shelf Pack
			Inch	mm	Inch	mm	Inch	mm	Inch	mm	Inch	mm	lb	g	
170M	037103029959	Carded	5	127	3/4	19	11/32	9	1/2	13	5/64	2	1.5	680	6
170D	037103029935	Carded	5	127	3/4	19	11/32	9	1/2	13	5/64	2	1.5	680	6
175M	037103030023	Carded	5	127	3/4	19	11/32	9	1/2	13	5/64	2	1.5	680	6
175D	037103030009	Carded	5	127	3/4	19	11/32	9	1/2	13	5/64	2	1.5	680	6

Shearcutter - Heavy-duty

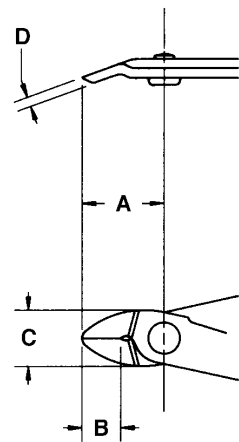

- Heavy-duty for IC pins, cables and harnesses
- Maximum durability
- Safety clip (on some models) prevents flying leads
- Maximum operator safety
- 1178M, 2178M feature light blue grips
- 1178D, 2178D feature static-dissapative black grips
- 2178M, 2178D feature safety clips
- 1178D, 2178D especially hardened and plated
- Flush cuts soft wire up to 14 AWG (1.6mm)

Safety Clip

Cat No.	UPC No.	Packed	Length		A		B		C		D		Pack Wt.		Shelf Pack
			Inch	mm	Inch	mm	Inch	mm	Inch	mm	Inch	mm	lb	g	
1178M	037103030825	Carded	5 5/8	143	29/32	23	13/32	10	17/32	14	1/8	3	1.62	735	6
1178D	037103030801	Carded	5 5/8	143	29/32	23	13/32	10	17/32	14	1/8	3	1.62	735	6
2178M	037103039590	Carded	5 5/8	143	29/32	23	13/32	10	17/32	14	1/8	3	1.62	735	6
2178D	037103031648	Carded	5 5/8	143	29/32	23	13/32	10	17/32	14	1/8	3	1.62	735	6

2 Piece Shearcutter / Plier Set

- The most popular all-purpose miniature electronic flush cutter and needle-nose plier
- Superior overall quality
- Advanced handle design
- Highest quality carbon steel
- Non-glare black finish
- Lightweight construction



Cat No.	UPC No.	Description	Pack Wt.		Shelf Pack
			lb	g	
S2K	043127131790	Carded	2 piece set (170M and 378M) 10 each sets/case cut pack		10

Shearcutter - 75° Angle

- 75° angle for natural cutting position
- Provides superior sight lines
- Allows easier cutting in tight spaces
- Slim profile for better approach
- 75M features light blue grips
- 75D features static-dissipative black grips and especially hardened and plated
- Flush cuts soft wire up to 20 AWG (0.8mm)

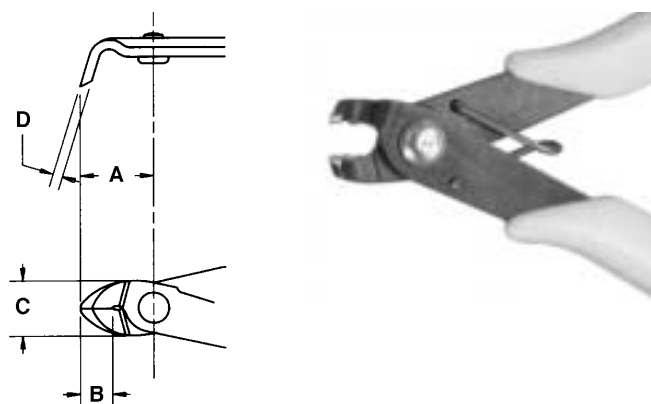

Cat No.	UPC No.	Packed	Length		A		B		C		D		Pack Wt.		Shelf Pack
			Inch	mm	Inch	mm	Inch	mm	Inch	mm	Inch	mm	lb	g	
75M	037103029454	Carded	5 7/16	138	3/4	19	5/16	8	1/2	13	5/64	2	1.5	680	6
75D	037103029430	Carded	5 7/16	138	3/4	19	5/16	8	1/2	13	5/64	2	1.5	680	6

Pliers - Serrated and Smooth Jaws

- Thin profile, long reach pliers
- For access into tight spaces
- Lightweight for maximum comfort
- For use in precision electronic assembly applications
- 378M, 378D feature serrated jaws
- 378SMM, 378SMD feature smooth jaws
- 378M, 378SMM feature light blue grips
- 378D, 378SMD feature static-dissipative black grips and especially hardened and plated



Cat No.	UPC No.	Packed	Length		A		C		D		E		Pack Wt.		Shelf Pack
			Inch	mm	Inch	mm	Inch	mm	Inch	mm	Inch	mm	lb	g	
378M	037103030252	Carded	5 1/2	140	1 1/2	32	17/32	14	1/8	3	3/64	1.2	1.62	735	6
378D	037103030238	Carded	5 1/2	140	1 1/2	32	17/32	14	1/8	3	3/64	1.2	1.62	735	6
378SMM	037103030320	Carded	5 1/2	140	1 1/2	32	17/32	14	1/8	3	3/64	1.2	1.62	735	6
378SMD	037103030306	Carded	5 1/2	140	1 1/2	32	17/32	14	1/8	3	3/64	1.2	1.62	735	6

Pliers and Cutters - With Red Cushion Grip Handles



- The exceptional strength and performance of Xcelite® pliers and cutters are the result of forged alloy steel construction, precision machining, and scientific proportioning
- Handles designed to fit the hand comfortably and to provide maximum leverage
- Cleanly machined and perfectly aligned jaws grip tightly and surely while easy cutting is assured by hand-honed, mated cutting edges
- For extra working comfort all models have permanent, red plastic-coated "Cushion-Grip" handles except Combination Slip Joint pliers
- These high quality pliers and cutters are featured in Xcelite® Attaché Tool Cases



NOTE: When using cutting pliers always wear safety glasses to protect eyes from wire clippings

Hard Wire (Piano and Music) Cutter 134CG

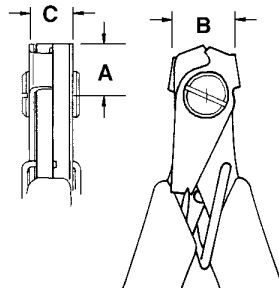

- Shear cutting action
- Ensures square cut ends
- Captures material on both sides of jaw, eliminates flying segments
- Patented spring loaded hold-down keeps material at 90° to tool blade
- Prevents material from forcing jaws apart
- Wire capacity .062
- Stranded cable capacity 1/16"

Cat No.	UPC No.	Packed	Length		A		B		C		Pack Wt.		Shelf Pack
			Inch	mm	Inch	mm	Inch	mm	Inch	mm	lb	g	
134CG	037103059994	Boxed	5.45	140	0.55	14	0.72	18.5	0.32	8.2	18.4	522	6

Diagonal Pliers 54CG

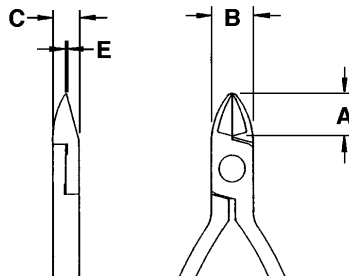

- For work in close quarters
- Standard beveled edges
- Forged alloy steel construction, precision machining and scientific proportioning
- Red plastic-coated cushion grip provides maximum leverage

Cat No.	UPC No.	Packed	Length		A		B		C		E		Pack Wt.		Shelf Pack
			Inch	mm	Inch	mm	Inch	mm	Inch	mm	Inch	mm	lb	g	
54CG	037103481580	Boxed	4	100	13/32	10	7/16	11	9/32	7	1/32	0.8	12.5	354	6
54CGV	037103481597	Carded	4	100	13/32	10	7/16	11	9/32	7	1/32	0.8	12.5	354	6

55CG

- All-purpose pliers
- Standard beveled edges
- Forged alloy steel construction, precision machining and scientific proportioning
- Exceptional strength and performance
- Red plastic-coated cushion grip provides maximum leverage

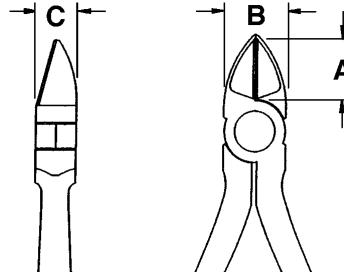

Cat No.	UPC No.	Packed	Length		A		B		C		E		Pack Wt.		Shelf Pack
			Inch	mm	Inch	mm	Inch	mm	Inch	mm	Inch	mm	lb	g	
55CG	037103481603	Boxed	5	125	3/4	19	19/32	15	3/8	10	-	-	22.2	629	6
55CGV	037103481610	Carded	5	125	3/4	19	19/32	15	3/8	10	-	-	22.2	629	6

64CG

- For use in close quarters and semi-flush tip cutting of fine wires
- Forged alloy steel construction, precision machining and scientific proportioning
- Exceptional strength and performance
- Red plastic-coated cushion grip provides maximum leverage

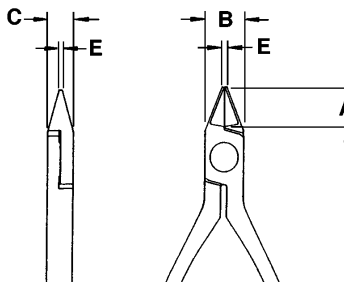

Cat No.	UPC No.	Packed	Length		A		B		C		E		Pack Wt.		Shelf Pack
			Inch	mm	Inch	mm	Inch	mm	Inch	mm	Inch	mm	lb	g	
64CG	037103481757	Boxed	4	100	13/32	10	7/16	11	9/32	7	1/32	0.8	12.5	354	6
64CGV	037103481764	Carded	4	100	13/32	10	7/16	11	9/32	7	1/32	0.8	12.5	354	6

66CG

- All-purpose pliers
- Standard beveled edges
- Forged alloy steel construction, precision machining and scientific proportioning
- Exceptional strength and performance
- Red plastic-coated cushion grip provides maximum leverage

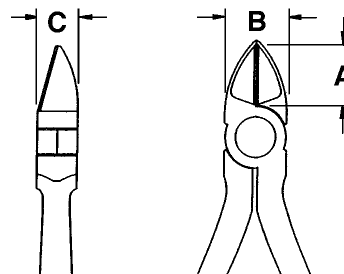

Cat No.	UPC No.	Packed	Length		A		B		C		E		Pack Wt.		Shelf Pack
			Inch	mm	Inch	mm	Inch	mm	Inch	mm	Inch	mm	lb	g	
66CG	037103481771	Boxed	6	152	27/32	21	11/16	17	7/16	11	-	-	42.2	1196	6
66CGV	037103481788	Carded	6	152	27/32	21	11/16	17	7/16	11	-	-	42.2	1196	6

Stainless Diagonal Cutting - Slim Nose

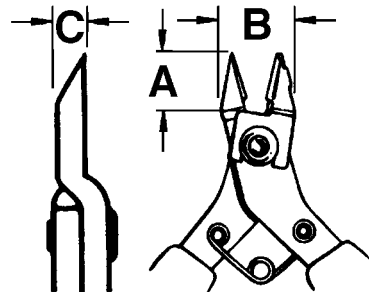

Klip Grip Feature

- For cutting soft non-ferrous wire, max. as specified, No. 25 gauge (.018") and smaller soft steel wire
- Ideal for tip cutting in delicate electronic circuitry work and where small lightweight pliers are required for use by women engaged in electronic component assembly
- Precision-machined, ground flush cutting edges
- Back clearance
- Offers up to 4 times the life of regular miniature diagonal pliers
- Patented handle spring

Cat No.	UPC No.	Packed	Description	Length		A		B		C		Max. Dia Soft non Ferrous Wire Inch	Soft Steel Wire Inch	Shelf Pack
				Inch	mm	Inch	mm	Inch	mm	Inch	mm			
113CG	037103489784	Bagged	Flush Cut	4 1/2	114	3/8	9	13/32	12	7/32	6	.065	.018	6
113CGV	037103489791	Carded	Flush Cut	4 1/2	114	3/8	9	13/32	12	7/32	6	.065	.018	6
115CG	037103489821	Bagged	Flush Cut	5	127	1/2	13	1/2	3	7/32	6	.083	.018	6
115CGV	037103489838	Carded	Flush Cut	5	127	1/2	13	1/2	3	7/32	6	.083	.018	6
117CG	037103489999	Bagged	Flush Cut	4	100	5/16	8	15/32	12	7/32	6	.051	.018	6
117CGV	037103490001	Carded	Flush Cut	4	100	5/16	8	15/32	12	7/32	6	.051	.018	6
200SS	037103463609	Boxed	Plier Spring	--	--	--	--	--	--	--	--	--	--	1

57CG

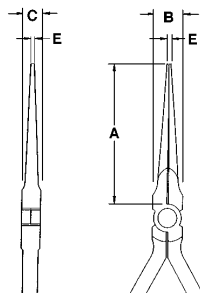

- Standard pliers
- For firm gripping and looping of wire
- Fine serrated jaw and coil spring
- Forged alloy steel construction, precision machining and scientific proportioning
- Red plastic-coated cushion grip provides maximum leverage

Cat No.	UPC No.	Packed	Length		A		B		C		E		Pack Wt. lb g	Shelf Pack
			Inch	mm	Inch	mm	Inch	mm	Inch	mm				
57CG	037103481641	Boxed	5 11/16	144	-	-	15/32	12	1/4	6	1/16	1.5	20.8 590	6
57CGV	037103481658	Carded	5 11/16	144	-	-	15/32	12	1/4	6	1/16	1.5	20.8 590	6

51CG

- For firm gripping and looping of wire
- Serrated jaw
- Forged alloy steel construction, precision machining and scientific proportioning
- Side cutter feature
- Red plastic-coated cushion grip provides maximum leverage

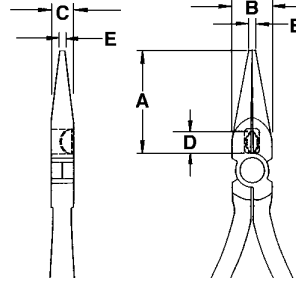

Cat No.	UPC No.	Packed	Length		A		B		C		D		E		Pack Wt.		Shelf Pack
			Inch	mm	Inch	mm	Inch	mm	Inch	mm	Inch	mm	Inch	mm	lb	g	
51CG	037103481528	Boxed	6	152	1 7/8	48	11/16	17	3/8	10	1/2	13	3/32	2.4	36.6	1038	6
51CGV	037103481535	Carded	6	152	1 7/8	48	11/16	17	3/8	10	1/2	13	3/32	2.4	36.6	1038	6

59CG

- Electrician's chain nose pliers
- Serrated jaw for gripping and high leverage
- Forged alloy steel construction, precision machining and scientific proportioning
- Offers long reach
- Red plastic-coated cushion grip provides maximum leverage

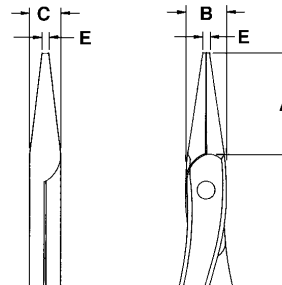

Cat No.	UPC No.	Packed	Length		A		B		C		E		Pack Wt.		Shelf Pack
			Inch	mm	Inch	mm	Inch	mm	Inch	mm	Inch	mm	lb	g	
59CG	037103481689	Boxed	8	200	1 1/2	32	9/16	14	15/32	12	3/32	2.4	44.5	1262	6
59CGV	037103481696	Carded	8	200	1 1/2	32	9/16	14	15/32	12	3/32	2.4	44.5	1262	6

Utility Pliers 50CG Ignition Pliers

- Ignition pliers
- Narrow jaw for close work
- 3-jaw opening adjustment to 1/2"
- Forged alloy steel construction, precision machining and scientific proportioning
- Red plastic-coated cushion grip provides maximum leverage



Cat No.	UPC No.	Packed	Length		Opening		Shelf Pack
			Inch	mm	Inch	mm	
50CG	037103481504	Boxed	5	127	1/2	12.7	6
50CGV	037103481511	Carded	5	127	1/2	12.7	6

53CG Tongue and Groove Pliers



- All-purpose pliers
- Angled serrated teeth in jaws
- Maximum opening 1 1/8"/28mm
- 4-position machined rib lock design
- Forged alloy steel construction, precision machining and scientific proportioning
- Red plastic-coated cushion grip provides maximum leverage

Cat No.	UPC No.	Packed	Length		Opening		Shelf Pack
			Inch	mm	Inch	mm	
53CG	037103481566	Boxed	7	178	1 1/8	28	6
53CGV	037103481573	Carded	7	178	1 1/8	28	6

Combination Slip Joint Pliers



- For general and heavy-duty use
- Angled serrated teeth in jaws
- Forged alloy steel construction, precision machining and scientific proportioning
- Sturdy, chrome-plated pliers

Cat No.	UPC No.	Packed	Length		Shelf Pack
			Inch	mm	
76C	037103481986	Boxed	6	150	6
76CV	037103481993	Carded	6	150	6
78CV	037103482013	Carded	8	200	6

Special Tools for Special Problems - Seizer



- Seizer forceps
- Versatile tool with unusual holding qualities
- Clamps firmly to hold wires for soldering
- Acts as a heat sink and retrieves small parts from hard-to-reach places
- Precision-machined from perfectly tempered stainless steel
- Box-joint construction
- 3-position snap lock
- Serrated jaws

Cat No.	UPC No.	Packed	Description	Length		Shelf Pack
				Inch	mm	
32H	037103481344	Boxed	Straight nose jr. seizer, smooth jaws	5.0	127	6
32HV	037103481351	Carded	Straight nose jr. seizer, smooth jaws	5.0	127	6
33H	037103481368	Boxed	Curved nose jr. seizer, smooth jaws	5.0	127	6
33HV	037103481375	Carded	Curved nose jr. seizer, smooth jaws	5.0	127	6
42H	037103481405	Boxed	Straight nose seizer, serrated jaws	5.5	140	6
42HV	037103481412	Carded	Straight nose seizer, serrated jaws	5.5	140	6
43H	037103481429	Boxed	Curved nose seizer, serrated jaws	5.5	140	6
43HV	037103481436	Carded	Curved nose seizer, serrated jaws	5.5	140	6

Wire Strippers & Cutters with Cushion Grip Handles 100X

- Cuts and strips both solid and stranded wire cleanly, neatly
- Adjustable screw stop for different wire sizes
- Hardened with ground blades
- 101S specifications same as 100X except with spring-equipped self-opening handles
- Red plastic-coated cushion grip provides maximum leverage



Cat No.	UPC No.	Packed	Description	Length		Shelf Pack
				Inch	mm	
100X	037103483560	Boxed	Stripper, cutter	5	127	6
100XV	037103483577	Carded	Stripper, cutter	5	127	6
101S	037103483584	Boxed	Stripper, cutter-spring opening	5	127	6
101SV	037103483591	Carded	Stripper, cutter-spring opening	5	127	6

102S

- Deluxe wire stripper features new shape which fits hand easily and more comfortably
- Hardened steel
- All cutting surfaces (including "V" notches) fixture ground to ensure perfect shearing action every time
- Easily adjustable cam allows tool to be set to fit all commonly used insulated wires
- Smooth working safety lock
- Red plastic-coated cushion grip provides maximum leverage



Cat No.	UPC No.	Packed	Inch	Length		Shelf Pack
				mm		
102SV	037103490292	Carded	5 1/2	140	6	

103S

- For industrial use
- Unique cam stop adjustment for different wire sizes, stays put even with screw loose
- Red plastic-coated cushion grip provides maximum leverage



Cat No.	UPC No.	Packed	Inch	Length		Shelf Pack
				mm		
103S	037103483607	Boxed	5 1/4	133	6	
103SV	037103483614	Carded	5 1/4	133	6	

104CG Wire Stripper and Cutter



- For copper and aluminum wire 10-22 AWG
- Wide size-range bolt cutter / Screw sizing stations
- Scissors-action, up-front wire cutting and wire stripping
- Pliers nose
- Hardened pivot joint bushing and crimp stations
- Red cushion grip handle provides maximum leverage
- 104CGCS packaged on a clip strip merchandising wand

Cat No.	UPC No.	Packed	Length		Shelf Pack
			Inch	mm	
104CG	037103486820	Boxed	8 1/4	210	6
104CGV	037103486837	Carded	8 1/4	210	6

105CG Electrical Pliers



- Wire cutting and stripping edges conveniently located in front of pivot to allow use in tight places
- Needle nose pliers add wire pulling and bending capabilities
- Scissors-action stripper for cleaner, faster and more accurate stripping
- Serrated edge
- Xcelite® Catalog No. 105SCGV includes work-speeding automatic spring and lock
- Red cushion grip handle provides maximum leverage
- For copper and aluminum wire 10-22 AWG

Cat No.	UPC No.	Packed	Description	Length		Shelf Pack
				Inch	mm	
105CG	037103486974	Boxed	Stripper, cutter without spring and lock	6	150	6
105CGV	037103486981	Carded	Stripper, cutter without spring and lock	6	150	6
105SCGV	037103487001	Carded	Stripper, cutter-spring opening and lock	6	150	6

Snips



- Shearing action of 1 1/2"/38mm cut pointed blades prevents peaks on fine wires and filaments
- Useful for removing insulation and cutting light sheet metal
- Coil spring opens blades
- Safety latch
- Red plastic-coated cushion grip provides maximum leverage

Cat No.	UPC No.	Packed	Length		Opening		Shelf Pack
			Inch	mm	Inch	mm	
86CG	037103482129	Boxed	6 1/2	165	1 1/2	38	6
86CGV	037103482136	Carded	6 1/2	165	1 1/2	38	6

XL70 Offset Ratchet Screwdriver Set

- 19-piece midget, offset, reversible ratchet set
- All-purpose driver bits 1/4"/6mm hex shank
- Simple and easy-to-use for assembly, disassembly, adjustment and repair work involving Allen hex, Phillips® and slotted screws



Cat No.	UPC No.	Packed	Length		Description	Shelf Pack
			Inch	mm		
XL70	037103486691	Boxed	-	-	Complete set	1
XL3	037103486509	-	.050	1.27	Allen hex screw bit	6
XL4	037103486516	-	1/16	1.54	Allen hex screw bit	6
XL7	037103486547	-	7/64	1.54	Allen hex screw bit	6
XL8	037103486554	-	1/8	3.17	Allen hex screw bit	6
XL10	037103486578	-	5/32	3.97	Allen hex screw bit	6
XL12	037103486585	-	3/16	4.76	Allen hex screw bit	6
XL14	037103486592	-	7/32	5.56	Allen hex screw bit	6
XL16	037103486608	-	1/4	6	Allen hex screw bit	6
XL18	037103486622	-	5/16	7.94	Allen hex screw bit	6
XL20	037103486639	-	No. 1	-	No. 1 Phillips screw bit	6
XL21	037103486646	-	No. 2	-	No. 2 Phillips screw bit	6
XL24	037103486653	-	6 1/4 /6 hex to 1/4 /6 square		Adapter bit	6
XL25	037103486660	-	3/16	4.76	Slotted screw bit	6
XL27	037103486677	-	-	-	Reversible ratchet	6
XL50	037103486684	-	-	-	Spinner-extension	6

XTZ1V ToolZall® Technician Multipurpose Tool

- Wire Stripper
- Needle nose pliers
- Wire cutter
- Wire bender
- 3 Flat head slotted screwdrivers
- Phillips screwdriver
- Awl
- English and metric rules
- Can and bottle openers
- Metal and wood files
- Knife
- Built from stainless steel for durability
- Comfort grip handles
- 4" compact size folded
- Limited lifetime warranty



Cat No.	UPC No.	Packed	Description	Shelf Pack
XTZ1V	037103154699	Carded	ToolZall® Technician 16 in 1 multipurpose tool	3

XL75 Offset Ratchet Screwdriver Set



- 5-piece set
- Driver bits 1/4"/6mm hex shank
- See-through plastic pouch

Cat No.	UPC No.	Packed	Description	Shelf Pack
XL75	037103486707	Boxed	Complete set	1
XL75V	037103486714	Carded	Complete set vacuum packed	1
XL25	037103486660	-	Slotted screw bit 3/16 " /4.76mm	6
XL17	037103486615	-	Slotted screw bit 1/4" / 6mm	6
XL20	037103486639	-	Phillips screw bit No. 1	6
XL21	037103486646	-	Phillips screw bit No. 2	6
XL27	037103486677	-	Reversible ratchet arm	6

Adjustable Wrenches



- Rugged construction
- Quick, 1-hand adjustment
- Chrome-plated, polished heads
- Cushion grip handle
- Red cushion grip handle provides maximum leverage

Cat No.	UPC No.	Packed	Length		Jaw Capacity		Shelf Pack
			Inch	mm	Inch	mm	
44CG	037103481443	Boxed	4	100	1/2	13	6
44CGV	037103481450	Carded	4	100	1/2	13	6
46CG	037103481467	Boxed	6	150	15/16	24	6
46CGV	037103481474	Carded	6	150	15/16	24	6
48CG	037103481481	Boxed	8	200	1 1/8	29	6
48CGV	037103481498	Carded	8	200	1 1/8	29	6

Electrician's Knife

- Both a knife and a screwdriver
- Screwdriver blade with sharp edge for scraping insulation



Cat No.	UPC No.	Packed	Description	Shelf Pack
K22	037103484239	Boxed	Electrician's knife	6
K22V	037103484246	Carded	Electrician's knife	6

Heat Sink

- Protects transistors and other delicate electronic components from heat during soldering
- Copper jaw for greatest possible heat absorption and dissipation (solder will not stick to finish)
- Nickel-plated finish
- Positive no-slip spring tension action
- Red plastic-coated cushion grip provides maximum leverage



Cat No.	UPC No.	Packed	Description	Length		Shelf Pack
				Inch	mm	
80	037103482044	Boxed	Heat sink	3 1/8	80	6
80V	037103482051	Carded	Heat sink	3 1/8	80	6

Premium Stainless Steel Tweezers - Made in U.S.A.



Straight point

Straight point small



Fine taper point

Tapered-Extra fine

Curved tip-thin

- High quality
- For electronic use
- Manufactured from anti-magnetic, anti-acid stainless steel
- Working tips hand finished for precise alignment
- Overall length is 4 1/2"
- Smooth jaws

Cat No.	UPC No.	Packed	Description	Shelf Pack
XSST3	037103490957	Boxed	Straight point	6
XSST3V	037103490964	Carded	Straight point carded	6
XSST3CV	037103490988	Carded	Straight point small carded	6
XSST4V	037103491008	Carded	Fine taper point carded	6
XSST5V	037103491022	Carded	Tapered-extra fine carded	6
XSST7	037103491039	Boxed	Curved tip-thin	6
XSST7V	037103491046	Carded	Curved tip-thin carded	6

General Duty Tweezers



Sharp point

Cross lock

Cross lock



Curved

Straight

Round point

Cat No.	UPC No.	Packed	Length		Description	Shelf Pack
			Inch	mm		
XHT434	037103487636	Boxed	4 3/4	121	Smooth sharp points	6
XHT412	037103487629	Boxed	4 1/2	115	Self closing, smooth sharp points for holding work	6
XHT612	037103487650	Boxed	6	165	Self closing, especially good for soldering and gluing	6
XHT678	037103487667	Boxed	6 7/8	174	For better view of close work for hard to reach places	6
XHT700	037103487674	Boxed	7	178	Slender tapered point to fit in tight places	6
XHT600	037103487643	Boxed	6	152	Serrated points for sure grips opens to 3/4" 19mm width	6

Precision Knives and Blades

- A fine selection of six knives from lightweight to heavy-duty for the professional and hobbyist
- Precision made for durable life
- Interchangeable blades held firm in sure-locking four jaw chuck
- Stay sharp blades are made from surgical steel and honed for closest cutting and long lasting edge

Light-duty

- Designed for light-duty cutting on paper, soft and light-weight materials or wood
- XN100CS packaged on a clip strip merchandising wand



Cat No.	UPC No.	Packed	Length		Type of blade	Shelf Pack
			Inch	mm		
XN100	037103487681	Boxed	5 13/16	148	XNB103	6
XN100B	037103488466	Boxed	Same as XN-100 – Tube			24

Medium-duty

- Designed for heavy paper and medium density materials



Cat No.	UPC No.	Packed	Length		Type of blade	Shelf Pack
			Inch	mm		
XN200	037103487698	Boxed	5 3/4	146	XNB205	6

Heavy-duty Plastic Handle

- Designed for working with hardwood, plastic and other difficult to cut materials



Cat No.	UPC No.	Packed	Length		Type of blade	Shelf Pack
			Inch	mm		
XN210	037103487704	Boxed	5 7/16	137	XNB201	6

Carving

- For those who prefer a metal handled knife
- Cuts through hardwood and plastics



Cat No.	UPC No.	Packed	Length		Type of blade	Shelf Pack
			Inch	mm		
XN300	037103487728	Boxed	5 5/8	144	XNB301	6

Light and Medium-duty Knife Set



- For a wide range of cutting operations
- Contains 10 assorted blades

Cat No.	UPC No.	Packed	Description	Shelf Pack
XNS100	037103487742	Boxed	XN100 and XN200 knives & 10 assorted blades	6

Blades

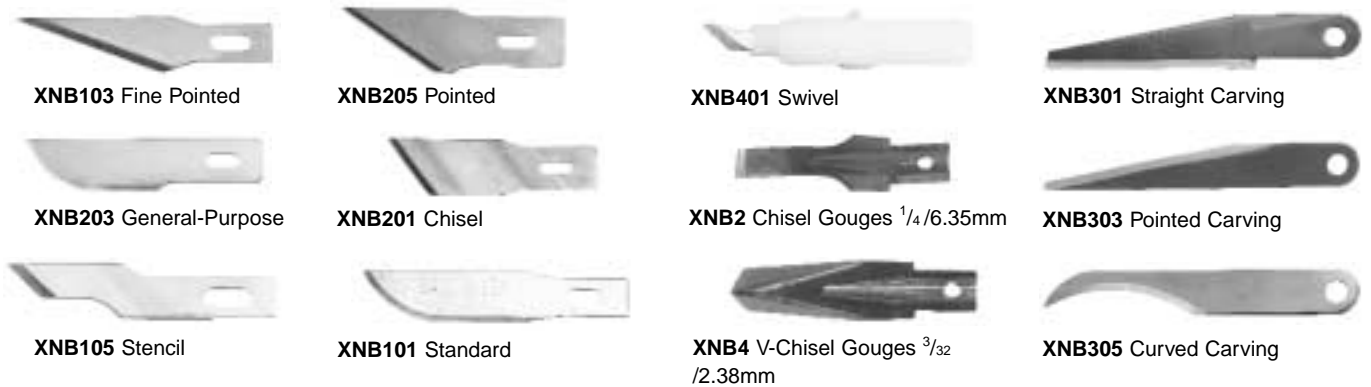

- Blades interchangeable with other similar knives
- Safely packed in transparent plastic containers and carded
- Bulk packed
- Number of blades per container shown in tables

Cat No.	UPC No.	Qty.	Description	Fits Knife	Shelf Pack
XNB103	037103487766	5	For most detailed cutting and stripping	XN100	6
XNB103B	037103488473	100	For most detailed cutting and stripping	XN100	1
XNB203	037103487797	5	For most cutting requirements	XN100/210/220/300	6
XNB105	037103487773	5	For scoring and etching as well as stencil cutting	XN100	6
XNB205	037103487803	5	For close corner cuts on templates, mates, gaskets, also trimming, stripping and de-burring	XN200/210/220/300	6
XNB201	037103487780	5	Rough shaping de-burring and chiseling	XN220/210/220/300	6
XNB101	037103487759	5	General-duty for cutting, carving and correcting stencils	XN100	6
XNB401	037103487810	5	For paper craft including decoupage and cutting film, masks, whenever the finest cuts are needed	XN400	6
XNB2	037103487872	2	Stay sharp edge for carving	XN300	6
XNB4	037103487896	2	For deeper "V" trough cuts	XN300	6
XNB301	037103487834	2	For general-purpose carving	XN300	6
XNB303	037103487841	2	For accurate carving details	XN300	6
XNB305	037103487858	2	For smoothing and shaping	XN300	6

TKX11 Multi-purpose Tool Kit

- 11 quality tools perfect for all types of routine repair and simple DIY'er projects
- Packed neatly in an attractive easy-to-store case



Cat No.	UPC No.	Packed	Inch	mm	Description	Shelf Pack
TKX11	037103487377	Boxed	-	-	Complete tool kit	1
R144	037103485403	Boxed	1/4 x 4	101	Round blade screwdriver	-
R184	037103485496	Boxed	1/8 x 4	101	Round blade screwdriver	-
X101	037103486394	Boxed	No. 1 Phillips x 3	76	Round blade screwdriver	-
8	037103487001	Boxed	1/4	-	Hex nutdriver	-
P12S	037103484857	Boxed	No. 0 Phillips x 2	51	Screwdriver	-
51CG	037103481528	Boxed	6	152	Long nose pliers with side cutter	-
46CG	037103481467	Boxed	6	152	Adjustable wrench	-
S141	037103485854	Boxed	1/4 x 11/4	32	Stubby square blade screwdriver	-
100X	037103483560	Boxed	-	-	Wire stripper & cut adj. screw top	-
W9210ME	037103458766	Boxed	1/2	13 x 10	3048mm Metric/English tape rule	-
76C	037103481986	Boxed	6	152	Combination plier, chrome plated	-

Model TCMB 100/STW and TCMB 100/MTW

The 100 Series Kits are all “The Largest and Most Elaborate”



- Contains 53 individual hand tools, 31 Series 99® interchangeable screwdriver/nutdriver blades and handles, and 2 specialized screwdriver/nutdriver kits (as listed)
- Extra large roller bearing wheels (3 5/8") with wide base for maximum stability and easy transport over rough pavement or stairs.
- Extra wide, comfortable extension handle is molded into case to prevent wear.
- Size: 18" x 15" x 8" deep.
- Extension handle locks in place automatically when extended and retracted. Easy one-handed release.
- Two tote handles for convenience. Both are spring loaded for protection.
- “D” ring provided for Bunji cords to carry other cases on top
- Case is super tough, black polyethylene rotationally molded for maximum strength. Minimum wall thickness of 0.120".
- 3-panel hinged tool pallet in lid plus additional pallet in bottom.
- Extra large storage space for additional equipment.
- Extra large all new screen mesh literature/utility pocket.

Cat No.	UPC No.	Description
TCMB100STW	037103107787	Tool case with tools
TCMB100MTW	037103107794	Tool case only-NO TOOLS

Cat No.	UPC No.	Qty.	Cat No.	UPC No.	Qty.	Cat No.	UPC No.	Qty.
991	Handle – regular	1	57CG	Needle nose pliers 5 1/2"/139mm	1	XST102	Phillips screwdriver	1
991R	Handle – regular ratchet	1	59CG	Chain nose pliers 8"/203mm	1	P18	Hex socket screwdriver	1
994R	Handle – Tee ratchet	1	86CG	Electronic snips	1	P19	Hex socket screwdriver	1
99X5	Extension	1	103S	Wire stripper/cutter	1	HS6	Nutdriver—hollow shaft	1
99X10	Extension	1	K22	Electrician's knife	1	HS8	Nutdriver—hollow shaft	1
9938	Reamer	1	M60	Mini drivers	1	HS10	Nutdriver—hollow shaft	1
99125	Slotted screw blade	1	XL75	Offset ratchet screwdrivers	1	HS11	Nutdriver—hollow shaft	1
99250	Slotted screw blade	1	600	Combination screwdriver-nutdriver tool	1	HS12	Nutdriver—hollow shaft	1
99312	Slotted screw blade	1	SB1	Dual reversible screwdriver blade	1	HS14	Nutdriver—hollow shaft	1
99811	Slotted screw blade	1	R144	Slotted screwdriver	1	HS16	Nutdriver—hollow shaft	1
99820	Phillips screw blade	1	R146	Slotted screwdriver	1	HS18	Nutdriver—hollow shaft	1
99821	Phillips screw blade	1	R181	Slotted screwdriver	1	8M	Nutdriver—magnetic	1
99822	Phillips screw blade	1	R184	Slotted screwdriver	1	10M	Nutdriver—magnetic	1
9961 - 69	Bristol 6-flute multi. spline blades (9)	1	R3164	Slotted screwdriver	1	P3	Midget nutdriver	1
9920 - 26	Allen hex socket type blades (7)	1	R3166	Slotted screwdriver (insulated)	1	P4	Midget nutdriver	1
99764	Allen hex socket type blade	1	R3323	Slotted screwdriver	1	P5	Midget nutdriver	1
99964	Allen hex socket type blade	1	R5325	Slotted screwdriver	1	P6	Midget nutdriver	1
42H	Straight nose seizer	1	S388	Slotted screwdriver	1	P7	Midget nutdriver	1
46CG	Adjustable wrench 6"/152mm	1	S3161	Slotted screwdriver	1	P8	Midget nutdriver	1
50CG	Midget slip joint pliers 5"/127mm	1	S5161	Slotted screwdriver	1	P9	Midget nutdriver	1
51CG	Long nose pliers 6"/152mm	1	S5166	Slotted screwdriver	1	P10	Midget nutdriver	1
53CG	Utility pliers 7"/178mm	1	SX101	Phillips screwdriver	1	P11	Midget nutdriver	1
54CG	Diagonal pliers 4"/101mm	1	XST100	Phillips screwdriver	1	P12	Midget nutdriver	1
66CG	Diagonal pliers 6"/152mm	1	XST101	Phillips screwdriver	1	TA2	Torque amplifier handle	1

Model TC100ST and TC100MT

- Largest, most elaborate of tool cases
- Contains 53 individual hand tools, 31 Series 99® interchangeable screwdriver/nutdriver blades and handles, and 2 specialized screwdriver/nutdriver kits (as listed)
- Covered with attractive durable charcoal brown leather-grain Marvelon vinyl
- Removable 3-panel hinged tool pallet in lid plus additional pallet in bottom
- Solid brass hardware with anodized aluminum divider in bottom
- Size: 18 3/4" x 12 1/2" x 5 7/8"/476mm x 318mm x 149mm



Cat No.	UPC No.	Description
TC100ST	037103486271	Tool case with tools
TC100MT	037103486257	Tool case only-NO TOOLS

Cat No.	UPC No.	Qty.	Cat No.	UPC No.	Qty.	Cat No.	UPC No.	Qty.
991	Handle – regular	1	57CG	Needle nose pliers 5 1/2"/139mm	1	XST102	Phillips screwdriver	1
991R	Handle – regular ratchet	1	59CG	Chain nose pliers 8"/203mm	1	P18	Hex socket screwdriver	1
994R	Handle – Tee ratchet	1	86CG	Electronic snips	1	P19	Hex socket screwdriver	1
99X5	Extension	1	103S	Wire stripper/cutter	1	HS6	Nutdriver—hollow shaft	1
99X10	Extension	1	K22	Electrician's knife	1	HS8	Nutdriver—hollow shaft	1
9938	Reamer	1	M60	Mini drivers	1	HS10	Nutdriver—hollow shaft	1
99125	Slotted screw blade	1	XL75	Offset ratchet screwdrivers	1	HS11	Nutdriver—hollow shaft	1
99250	Slotted screw blade	1	600	Combination screwdriver-nutdriver tool	1	HS12	Nutdriver—hollow shaft	1
99312	Slotted screw blade	1	SB1	Dual reversible screwdriver blade	1	HS14	Nutdriver—hollow shaft	1
99811	Slotted screw blade	1	R144	Slotted screwdriver	1	HS16	Nutdriver—hollow shaft	1
99820	Phillips screw blade	1	R146	Slotted screwdriver	1	HS18	Nutdriver—hollow shaft	1
99821	Phillips screw blade	1	R181	Slotted screwdriver	1	8M	Nutdriver—magnetic	1
99822	Phillips screw blade	1	R184	Slotted screwdriver	1	10M	Nutdriver—magnetic	1
9961 - 69	Bristol 6-flute multi. spline blades (9)	1	R3164	Slotted screwdriver	1	P3	Midget nutdriver	1
9920 - 26	Allen hex socket type blades (7)	1	R3166	Slotted screwdriver (insulated)	1	P4	Midget nutdriver	1
99764	Allen hex socket type blade	1	R3323	Slotted screwdriver	1	P5	Midget nutdriver	1
99964	Allen hex socket type blade	1	R5325	Slotted screwdriver	1	P6	Midget nutdriver	1
42H	Straight nose seizer	1	S388	Slotted screwdriver	1	P7	Midget nutdriver	1
46CG	Adjustable wrench 6"/152mm	1	S3161	Slotted screwdriver	1	P8	Midget nutdriver	1
50CG	Midget slip joint pliers 5"/127mm	1	S5161	Slotted screwdriver	1	P9	Midget nutdriver	1
51CG	Long nose pliers 6"/152mm	1	S5166	Slotted screwdriver	1	P10	Midget nutdriver	1
53CG	Utility pliers 7"/178mm	1	SX101	Phillips screwdriver	1	P11	Midget nutdriver	1
54CG	Diagonal pliers 4"/101mm	1	XST100	Phillips screwdriver	1	P12	Midget nutdriver	1
66CG	Diagonal pliers 6"/152mm	1	XST101	Phillips screwdriver	1	TA2	Torque amplifier handle	1

Model TCA100ST and TCA100MT



- Contains 53 individual hand tools, 31 Series 99® interchangeable screwdriver/nutdriver blades and handles, and 2 specialized screwdriver/nutdriver kits (as listed)
- Hi-tech aluminum tool case with smooth finish, keyless combination lock and chrome-plated latches
- Tongue and groove lid with rubber gasket ensures a positive seal from dirt or water
- Case with removable 3-panel hinged tool pallet in lid plus additional panel in bottom
- Size: 17 5/8" x 12 5/8" x 7 7/8"/448mm x 321mm x 200mm

Cat No.	UPC No.	Description
TCA100ST	037103491343	Tool case with tools
TCA100MT	037103491336	Tool case only-NO TOOLS

Cat No.	UPC No.	Qty.	Cat No.	UPC No.	Qty.	Cat No.	UPC No.	Qty.
991	Handle – regular	1	57CG	Needle nose pliers 5 1/2"/139mm	1	XST102	Phillips screwdriver	1
991R	Handle – regular ratchet	1	59CG	Chain nose pliers 8"/203mm	1	P18	Hex socket screwdriver	1
994R	Handle – Tee ratchet	1	86CG	Electronic snips	1	P19	Hex socket screwdriver	1
99X5	Extension	1	103S	Wire stripper/cutter	1	HS6	Nutdriver—hollow shaft	1
99X10	Extension	1	K22	Electrician's knife	1	HS8	Nutdriver—hollow shaft	1
9938	Reamer	1	M60	Mini drivers	1	HS10	Nutdriver—hollow shaft	1
99125	Slotted screw blade	1	XL75	Offset ratchet screwdrivers	1	HS11	Nutdriver—hollow shaft	1
99250	Slotted screw blade	1	600	Combination screwdriver-nutdriver tool	1	HS12	Nutdriver—hollow shaft	1
99312	Slotted screw blade	1	SB1	Dual reversible screwdriver blade	1	HS14	Nutdriver—hollow shaft	1
99811	Slotted screw blade	1	R144	Slotted screwdriver	1	HS16	Nutdriver—hollow shaft	1
99820	Phillips screw blade	1	R146	Slotted screwdriver	1	HS18	Nutdriver—hollow shaft	1
99821	Phillips screw blade	1	R181	Slotted screwdriver	1	8M	Nutdriver—magnetic	1
99822	Phillips screw blade	1	R184	Slotted screwdriver	1	10M	Nutdriver—magnetic	1
9961 - 69	Bristol 6-flute multi. spline blades (9)	1	R3164	Slotted screwdriver	1	P3	Midget nutdriver	1
9920 - 26	Allen hex socket type blades (7)	1	R3166	Slotted screwdriver (insulated)	1	P4	Midget nutdriver	1
99764	Allen hex socket type blade	1	R3323	Slotted screwdriver	1	P5	Midget nutdriver	1
99964	Allen hex socket type blade	1	R5325	Slotted screwdriver	1	P6	Midget nutdriver	1
42H	Straight nose seizer	1	S388	Slotted screwdriver	1	P7	Midget nutdriver	1
46CG	Adjustable wrench 6"/152mm	1	S3161	Slotted screwdriver	1	P8	Midget nutdriver	1
50CG	Midget slip joint pliers 5"/127mm	1	S5161	Slotted screwdriver	1	P9	Midget nutdriver	1
51CG	Long nose pliers 6"/152mm	1	S5166	Slotted screwdriver	1	P10	Midget nutdriver	1
53CG	Utility pliers 7"/178mm	1	SX101	Phillips screwdriver	1	P11	Midget nutdriver	1
54CG	Diagonal pliers 4"/101mm	1	XST100	Phillips screwdriver	1	P12	Midget nutdriver	1
66CG	Diagonal pliers 6"/152mm	1	XST101	Phillips screwdriver	1	TA2	Torque amplifier handle	1

Model TCMB100ST and TCMB100MT

- Contains 53 individual hand tools, 31 Series 99® interchangeable screwdriver/nutdriver blades and handles, and 2 specialized screwdriver/nutdriver kits (as listed)
- Contains 3-panel hinged tool pallet in lid plus additional pallet in bottom
- Super tough, black polyethylene with rich looking black anodized aluminum hardware
- Size: 17 3/4" x 12 5/8" x 5 3/4"/451mm x 321mm x 146mm



Cat No.	UPC No.	Description
TCMB100ST	037103491990	Tool case with tools
TCMB100MT	037103491206	Tool case only-NO TOOLS

Cat No.	UPC No.	Qty.	Cat No.	UPC No.	Qty.	Cat No.	UPC No.	Qty.
991	Handle – regular	1	57CG	Needle nose pliers 5 1/2"/139mm	1	XST102	Phillips screwdriver	1
991R	Handle – regular ratchet	1	59CG	Chain nose pliers 8"/203mm	1	P18	Hex socket screwdriver	1
994R	Handle – Tee ratchet	1	86CG	Electronic snips	1	P19	Hex socket screwdriver	1
99X5	Extension	1	103S	Wire stripper/cutter	1	HS6	Nutdriver—hollow shaft	1
99X10	Extension	1	K22	Electrician's knife	1	HS8	Nutdriver—hollow shaft	1
9938	Reamer	1	M60	Mini drivers	1	HS10	Nutdriver—hollow shaft	1
99125	Slotted screw blade	1	XL75	Offset ratchet screwdrivers	1	HS11	Nutdriver—hollow shaft	1
99250	Slotted screw blade	1	600	Combination screwdriver-nutdriver tool	1	HS12	Nutdriver—hollow shaft	1
99312	Slotted screw blade	1	SB1	Dual reversible screwdriver blade	1	HS14	Nutdriver—hollow shaft	1
99811	Slotted screw blade	1	R144	Slotted screwdriver	1	HS16	Nutdriver—hollow shaft	1
99820	Phillips screw blade	1	R146	Slotted screwdriver	1	HS18	Nutdriver—hollow shaft	1
99821	Phillips screw blade	1	R181	Slotted screwdriver	1	8M	Nutdriver—magnetic	1
99822	Phillips screw blade	1	R184	Slotted screwdriver	1	10M	Nutdriver—magnetic	1
9961 - 69	Bristol 6-flute multi. spline blades (9)	1	R3164	Slotted screwdriver	1	P3	Midget nutdriver	1
9920 - 26	Allen hex socket type blades (7)	1	R3166	Slotted screwdriver (insulated)	1	P4	Midget nutdriver	1
99764	Allen hex socket type blade	1	R3323	Slotted screwdriver	1	P5	Midget nutdriver	1
99964	Allen hex socket type blade	1	R5325	Slotted screwdriver	1	P6	Midget nutdriver	1
42H	Straight nose seizer	1	S388	Slotted screwdriver	1	P7	Midget nutdriver	1
46CG	Adjustable wrench 6"/152mm	1	S3161	Slotted screwdriver	1	P8	Midget nutdriver	1
50CG	Midget slip joint pliers 5"/127mm	1	S5161	Slotted screwdriver	1	P9	Midget nutdriver	1
51CG	Long nose pliers 6"/152mm	1	S5166	Slotted screwdriver	1	P10	Midget nutdriver	1
53CG	Utility pliers 7"/178mm	1	SX101	Phillips screwdriver	1	P11	Midget nutdriver	1
54CG	Diagonal pliers 4"/101mm	1	XST100	Phillips screwdriver	1	P12	Midget nutdriver	1
66CG	Diagonal pliers 6"/152mm	1	XST101	Phillips screwdriver	1	TA2	Torque amplifier handle	1

Model TCS100ST and TCS100MT



- Contains 53 individual hand tools, 31 Series 99® interchangeable screwdriver/nutdriver blades and handles, and 2 specialized screwdriver/nutdriver kits (as listed)
- Case made from rugged Cordura® with dual heavy-duty zippers and soft leather wrapped handles
- Contains (on outside) 1 pocket on one side and 2 smaller pockets on opposite
- Size: 17" x 12" x 3 1/4"/432mm x 305mm x 83mm
- Cordura® is a registered trademark of DUPONT

Cat No.	UPC No.	Description
TCS100ST	037103491251	Tool case with tools
TCS100MT	037103491268	Tool case only-NO TOOLS

Cat No.	UPC No.	Qty.
991	Handle – regular	1
991R	Handle – regular ratchet	1
994R	Handle – Tee ratchet	1
99X5	Extension	1
99X10	Extension	1
9938	Reamer	1
99125	Slotted screw blade	1
99250	Slotted screw blade	1
99312	Slotted screw blade	1
99811	Slotted screw blade	1
99820	Phillips screw blade	1
99821	Phillips screw blade	1
99822	Phillips screw blade	1
9961-69	Bristol 6-flute multi. spline blades (9)	1
9920-26	Allen hex socket type blades (7)	1
99764	Allen hex socket type blade	1
99964	Allen hex socket type blade	1
42H	Straight nose seizer	1
46CG	Adjustable wrench 6"/152mm	1
50CG	Midget slip joint pliers 5"/127mm	1
51CG	Long nose pliers 6"/152mm	1
53CG	Utility pliers 7"/178mm	1
54CG	Diagonal pliers 4"/101mm	1
66CG	Diagonal pliers 6"/152mm	1

Cat No.	UPC No.	Qty.
57CG	Needle nose pliers 5 1/2"/139mm	1
59CG	Chain nose pliers 8"/203mm	1
86CG	Electronic snips	1
103S	Wire stripper/cutter	1
K22	Electrician's knife	1
M60	Mini drivers	1
XL75	Offset ratchet screwdrivers	1
600	Combination screwdriver-nutdriver tool	1
SB1	Dual reversible screwdriver blade	1
R144	Slotted screwdriver	1
R146	Slotted screwdriver	1
R181	Slotted screwdriver	1
R184	Slotted screwdriver	1
R3164	Slotted screwdriver	1
R3166	Slotted screwdriver (insulated)	1
R3323	Slotted screwdriver	1
R5325	Slotted screwdriver	1
S388	Slotted screwdriver	1
S3161	Slotted screwdriver	1
S5161	Slotted screwdriver	1
S5166	Slotted screwdriver	1
SX101	Phillips screwdriver	1
XST100	Phillips screwdriver	1
XST101	Phillips screwdriver	1

Cat No.	UPC No.	Qty.
XST102	Phillips screwdriver	1
P18	Hex socket screwdriver	1
P19	Hex socket screwdriver	1
HS6	Nutdriver—hollow shaft	1
HS8	Nutdriver—hollow shaft	1
HS10	Nutdriver—hollow shaft	1
HS11	Nutdriver—hollow shaft	1
HS12	Nutdriver—hollow shaft	1
HS14	Nutdriver—hollow shaft	1
HS16	Nutdriver—hollow shaft	1
HS18	Nutdriver—hollow shaft	1
8M	Nutdriver—magnetic	1
10M	Nutdriver—magnetic	1
P3	Midget nutdriver	1
P4	Midget nutdriver	1
P5	Midget nutdriver	1
P6	Midget nutdriver	1
P7	Midget nutdriver	1
P8	Midget nutdriver	1
P9	Midget nutdriver	1
P10	Midget nutdriver	1
P11	Midget nutdriver	1
P12	Midget nutdriver	1
TA2	Torque amplifier handle	1

Model TC150ST and TC150MT

- A carefully selected, intermediate assortment of Xcelite® hand tools
- Contains 23 individual hand tools, popular WP25 Weller® 25 watt soldering iron, 24 Series 99® interchangeable screwdriver/nutdriver blades and handles, XL70 offset ratchet screwdriver set, measuring tape and solder (as listed)
- Covered with attractive durable tan leather grain Marvelon vinyl
- Removable tool pallet in lid and bottom
- Solid brass hardware and padded handle with anodized aluminum divider in bottom
- Size: 18" x 12 5/8" x 4 1/4"/457mm x 321mm x 108mm



Cat No.	UPC No.	Description
TC150ST	037103486288	Tool case with tools
TC150MT	037103486264	Tool case only-NO TOOLS

Cat No.	UPC No.	Qty.
991, 994R	Handles (regular and ratchet Tee)	1
99X5	Extension	1
9920 - 26, 99764, 99964	Allen hex-socket type blades (9)	1
996 - 12	Hex nutdriver blades (7)	1
99250 & 99811	Hex nutdriver blades	1
99821 & 99822	Phillips screw blades	1
9938	Reamer	1
42H	Seizer	1
46CG	Adjustable wrench	1
50CG	Midget slip joint pliers 5"/127mm	1
53CG	7"/178mm Utility pliers	1

Cat No.	UPC No.	Qty.
51CG	Long nose pliers 6"/152mm	1
54CG	4"/102mm Diagonal	1
55CG	5"/127mm Diagonal	1
57CG	5 1/2"/102mm Diagonal	1
59CG	8"/203mm Chain nose pliers	1
86CG	Electronic snips	1
101S	Wire stripper	1
K22	Electrician's knife	1
R181	Slotted screwdriver	1
R3323	Slotted screwdriver	1
R184	Slotted screwdriver	1
R3164	Slotted screwdriver	1

Cat No.	UPC No.	Qty.
S5166	Slotted screwdriver	1
S3161	Slotted screwdriver	1
SX101	Phillips screwdriver	1
XL75	5-piece set in see-thru plastic pouch	1
600	Combination Dual Nutdriver Handle	1
W9210ME	10-foot tape	1
HS14	Hollow shaft	1
HS16	Hollow shaft	1
8M	Magnetic	1
10M	Magnetic	1
WP25	Weller 25 watt soldering iron	1

Model TCA150ST and TCA150MT



- Carefully selected, intermediate assortment of Xcelite® hand tools and WP25 Weller® 25 watt soldering iron
- Contains 23 individual hand tools, 24 Series 99® interchangeable screwdriver/nutdriver blades and handles, XL70 offset ratchet screwdriver set, measuring tape and solder (as listed)
- High tech aluminum tool case with smooth finish, keyless combination lock and chrome-plated latch
- Tongue and groove lid with rubber gasket ensures a positive seal from dirt or water
- Case complete with removable pallet in lid plus additional panel in bottom
- Size: 17 5/8" x12 5/8" x 5 3/4"/448mm x 321mm x 146mm

Cat No.	UPC No.	Description
TCA150ST	037103491367	Tool case with tools
TCA150MT	037103491350	Tool case only-NO TOOLS

Cat No.	UPC No.	Qty.
991, 994R	Handles (regular and ratchet Tee)	1
99X5	Extension	1
9920 - 26, 99764, 99964	Allen hex-socket type blades (9)	1
996 - 12	Hex nutdriver blades (7)	1
99250 & 99811	Hex nutdriver blades	1
99821 & 99822	Phillips screw blades	1
9938	Reamer	1
42H	Seizer	1
46CG	Adjustable wrench	1
50CG	Midget slip joint pliers 5"/127mm	1
53CG	7"/178mm Utility pliers	1

Cat No.	UPC No.	Qty.
51CG	Long nose pliers 6"/152mm	1
54CG	4"/102mm Diagonal	1
55CG	5"/127mm Diagonal	1
57CG	5 1/2"/102mm Diagonal	1
59CG	8"/203mm Chain nose pliers	1
86CG	Electronic snips	1
101S	Wire stripper	1
K22	Electrician's knife	1
R181	Slotted screwdriver	1
R3323	Slotted screwdriver	1
R184	Slotted screwdriver	1
R3164	Slotted screwdriver	1

Cat No.	UPC No.	Qty.
S5166	Slotted screwdriver	1
S3161	Slotted screwdriver	1
SX101	Phillips screwdriver	1
XL75	5-piece set in see-thru plastic pouch	1
600	Combination Dual Nutdriver Handle	1
W9210ME	10-foot tape	1
HS14	Hollow shaft	1
HS16	Hollow shaft	1
8M	Magnetic	1
10M	Magnetic	1
WP25	Weller 25 watt soldering iron	1
RC60	Rosin core solder	1

Model TCMB150ST and TCMB150MT

- Carefully selected intermediate assortment of Xcelite® hand tools
- Contains 23 individual hand tools, popular WP25 Weller® 25 watt soldering iron, 24 Series 99® interchangeable screwdriver/nutdriver blades and handles, XL75 offset ratchet screwdriver set, measuring tape and solder (as listed)
- Super tough, black polyethylene with rich looking black anodized aluminum hardware
- Size: 17 3/4" x 12 5/8" x 4 3/4"/451mm x 321mm x 121mm



Cat No.	UPC No.	Description
TCMB150ST	037103491213	Tool case with tools
TCMB150MT	037103491220	Tool case only-NO TOOLS

Cat No.	UPC No.	Qty.
991, 994R	Handles (regular and ratchet Tee)	1
99X5	Extension	1
9920 - 26, 99764, 99964	Allen hex-socket type blades (9)	1
996 - 12	Hex nutdriver blades (7)	1
99250 & 99811	Hex nutdriver blades	1
99821 & 99822	Phillips screw blades	1
9938	Reamer	1
42H	Seizer	1
46CG	Adjustable wrench	1
50CG	Midget slip joint pliers 5"/127mm	1
53CG	7"/178mm Utility pliers	1

Cat No.	UPC No.	Qty.
51CG	Long nose pliers 6"/152mm	1
54CG	4"/102mm Diagonal	1
55CG	5"/127mm Diagonal	1
57CG	5 1/2"/102mm Diagonal	1
59CG	8"/203mm Chain nose pliers	1
86CG	Electronic snips	1
101S	Wire stripper	1
K22	Electrician's knife	1
R181	Slotted screwdriver	1
R3323	Slotted screwdriver	1
R184	Slotted screwdriver	1
R3164	Slotted screwdriver	1

Cat No.	UPC No.	Qty.
S5166	Slotted screwdriver	1
S3161	Slotted screwdriver	1
SX101	Phillips screwdriver	1
XL75	5-piece set in see-thru plastic pouch	1
600	Combination Dual Nutdriver Handle	1
W9210ME	10-foot tape	1
HS14	Hollow shaft	1
HS16	Hollow shaft	1
8M	Magnetic	1
10M	Magnetic	1
WP25	Weller 25 watt soldering iron	1

Model TCMG150ST and TCMG150MT



- Carefully selected intermediate assortment of Xcelite® hand tools
- Contains 23 individual hand tools, popular WP25 Weller® 25 watt soldering iron, 24 Series 99® interchangeable screwdriver/nutdriver blades and handles, XL75 offset ratchet screwdriver set, measuring tape and solder (as listed)
- Durable, double skin blow-molded plastic case
- Size: 17 3/4" x 12 5/8" x 4 3/4"/451mm x 321mm x 121mm

Cat No.	UPC No.	Description
TCMG150ST	037103162755	Tool case with tools
TCMG150MT	037103162762	Tool case only-NO TOOLS

Cat No.	UPC No.	Qty.	Cat No.	UPC No.	Qty.	Cat No.	UPC No.	Qty.
991, 994R	Handles (regular and ratchet Tee)	1	51CG	Long nose pliers 6"/152mm	1	S5166	Slotted screwdriver	1
99X5	Extension	1	54CG	4"/102mm Diagonal	1	S3161	Slotted screwdriver	1
9920 - 26, 99764, 99964	Allen hex-socket type blades (9)	1	55CG	5"/127mm Diagonal	1	SX101	Phillips screwdriver	1
996 - 12	Hex nutdriver blades (7)	1	57CG	5 1/2"/102mm Diagonal	1	XL75	5-piece set in see-thru plastic pouch	1
99250 & 99811	Hex nutdriver blades	1	59CG	8"/203mm Chain nose pliers	1	600	Combination Dual Nutdriver Handle	1
99821 & 99822	Phillips screw blades	1	86CG	Electronic snips	1	W9210ME	10-foot tape	1
9938	Reamer	1	101S	Wire stripper	1	HS14	Hollow shaft	1
42H	Seizer	1	K22	Electrician's knife	1	HS16	Hollow shaft	1
46CG	Adjustable wrench	1	R181	Slotted screwdriver	1	8M	Magnetic	1
50CG	Midget slip joint pliers 5"/127mm	1	R3323	Slotted screwdriver	1	10M	Magnetic	1
53CG	7"/178mm Utility pliers	1	R184	Slotted screwdriver	1	WP25	Weller 25 watt soldering iron	1
			R3164	Slotted screwdriver	1			

Model TCS150ST and TCS150MT

- Carefully selected, intermediate assortment of Xcelite® hand tools
- Contains 23 individual hand tools, popular WP25 Weller® 25 watt soldering iron, 24 Series 99® interchangeable screwdriver / nutdriver blades and handles, XL75 offset ratchet screwdriver set, measuring tape and solder (as listed)
- Case made from rugged Cordura® with heavy-duty zipper and soft leather wrapped handles
- Contains (on outside) 1 pocket on 1 side and 2 smaller pockets on opposite
- Cordura® is a registered trademark of DUPONT
- Size: 17" x 12" X 3"/432mm x 305mm x 76mm



Cat No.	UPC No.	Description
TCS150ST	037103491275	Tool case with tools
TCS150MT	037103491282	Tool case only-NO TOOLS

Cat No.	UPC No.	Qty.	Cat No.	UPC No.	Qty.	Cat No.	UPC No.	Qty.
991, 994R	Handles (regular and ratchet Tee)	1	51CG	Long nose pliers 6"/152mm	1	S5166	Slotted screwdriver	1
99X5	Extension	1	54CG	4"/102mm Diagonal	1	S3161	Slotted screwdriver	1
9920 - 26, 99764, 99964	Allen hex-socket type blades (9)	1	55CG	5"/127mm Diagonal	1	SX101	Phillips screwdriver	1
996 - 12	Hex nutdriver blades (7)	1	57CG	5 1/2"/102mm Diagonal	1	XL75	5-piece set in see-thru plastic pouch	1
99250 & 99811	Hex nutdriver blades	1	59CG	8"/203mm Chain nose pliers	1	600	Combination Dual Nutdriver Handle	1
99821 & 99822	Phillips screw blades	1	86CG	Electronic snips	1	W9210ME	10-foot tape	1
9938	Reamer	1	101S	Wire stripper	1	HS14	Hollow shaft	1
42H	Seizer	1	K22	Electrician's knife	1	HS16	Hollow shaft	1
46CG	Adjustable wrench	1	R181	Slotted screwdriver	1	8M	Magnetic	1
50CG	Midget slip joint pliers 5"/127mm	1	R3323	Slotted screwdriver	1	10M	Magnetic	1
53CG	7"/178mm Utility pliers	1	R184	Slotted screwdriver	1	WP25	Weller 25 watt soldering iron	1
			R3164	Slotted screwdriver	1			

Model TC200ST and TC200MT



- Fine blending of quality, economy and flexibility
- Contains 10 individual hand tools and 27 Series 99® interchangeable screwdriver/nutdriver blades and handles (as listed)
- Case covered with attractive durable black leather-grain Marvelon vinyl
- Removable tool pallet in lid
- Solid brass hardware and padded handle with anodized aluminum divider in bottom
- Size: 18" x 12 5/8" x 4 1/4"/457mm x 321mm x 108mm

Cat No.	UPC No.	Description
TC200ST	037103486301	Tool case with tools
TC200MT	037103486295	Tool case only-NO TOOLS

Cat No.	UPC No.	Qty.
991	Straight handle	1
994	Tee handle	1
9920 - 9926	Hex socket screw blades(7)	1
99764	Hex socket screw blade	1
99964	Hex socket screw blade	1
9938	Reamer	1
99X5	Extension	1
99820	Phillips screw blade	1
99821	Phillips screw blade	1
99822	Phillips screw blade	1
99125	Slotted screw blade	1

Cat No.	UPC No.	Qty.
99811	Slotted screw blade	1
99250	Slotted screw blade	1
99312	Slotted screw blade	1
996	Hex nutdriver blade	1
998	Hex nutdriver blade	1
9910	Hex nutdriver blade	1
9911	Hex nutdriver blade	1
9912	Hex nutdriver blade	1
9914	Hex nutdriver blade	1
9916	Hex nutdriver blade	1

Cat No.	UPC No.	Qty.
43H	Curved nose seizer 6"/152mm	1
46CG	Adjustable wrench 6"/152mm	1
51CG	Long nose pliers 6 1/2"/165mm	1
53CG	Utility pliers 7"/178mm	1
64CG	Diagonal pliers 4"/101mm	1
55CG	Diagonal pliers 5"/127mm	1
57CG	Needle nose pliers 5 1/2"/139mm	1
86CG	Electronic snips	1
101S	Wire stripper-cutter	1
K22	Electrician's knife	1

Model TCSE200ST and TCSE200MT



- Unique blend of quality, economy and flexibility
- Contains 10 individual hand tools and 27 Series 99® interchangeable screwdriver/nutdriver blades and handles (as listed)
- Lightweight case, made from rugged material which features a heavy-duty zipper and handles
- Removable tool pallet in lid
- Size: 13 1/2" x 10 1/2" x 2 3/8"/1343mm x 267mm x 60mm



Cat No.	UPC No.	Description
TCSE200ST	037103143679	Tool case with tools
TCSE200MT	037103146397	Tool case only-NO TOOLS

Cat No.	UPC No.	Qty.
991	Straight handle	1
994	Tee handle	1
9920 - 9926	Hex socket screw blades(7)	1
99764	Hex socket screw blade	1
99964	Hex socket screw blade	1
9938	Reamer	1
99X5	Extension	1
99820	Phillips screw blade	1
99821	Phillips screw blade	1
99822	Phillips screw blade	1
99125	Slotted screw blade	1

Cat No.	UPC No.	Qty.
99811	Slotted screw blade	1
99250	Slotted screw blade	1
99312	Slotted screw blade	1
996	Hex nutdriver blade	1
998	Hex nutdriver blade	1
9910	Hex nutdriver blade	1
9911	Hex nutdriver blade	1
9912	Hex nutdriver blade	1
9914	Hex nutdriver blade	1
9916	Hex nutdriver blade	1

Cat No.	UPC No.	Qty.
43H	Curved nose seizer 6"/152mm	1
46CG	Adjustable wrench 6"/152mm	1
51CG	Long nose pliers 6 1/2"/165mm	1
53CG	Utility pliers 7"/178mm	1
64CG	Diagonal pliers 4"/101mm	1
55CG	Diagonal pliers 5"/127mm	1
57CG	Needle nose pliers 5 1/2"/139mm	1
86CG	Electronic snips	1
101S	Wire stripper-cutter	1
K22	Electrician's knife	1

Model TCS200ST and TCS200MT



- Fine blending of quality, economy and flexibility
- Contains 10 individual hand tools and 27 Series 99® interchangeable screwdriver/nutdriver blades and handles (as listed)
- Case made from rugged Cordura® and features a heavy-duty zipper and soft leather wrapped handles
- Contains (on outside) 1 pocket on one side and 2 smaller pockets on opposite
- Size: 13 1/2" x 10 1/2" x 2 3/8"/343mm x 267mm x 60mm
- Cordura® is a registered trademark of DUPONT

Cat No.	UPC No.	Description
TCS200ST	037103490421	Tool case with tools
TCS200MT	037103490438	Tool case only-NO TOOL

Cat No.	UPC No.	Qty.
991	Straight handle	1
994	Tee handle	1
9920 - 9926	Hex socket screw blades(7)	1
99764	Hex socket screw blade	1
99964	Hex socket screw blade	1
9938	Reamer	1
99X5	Extension	1
99820	Phillips screw blade	1
99821	Phillips screw blade	1
99822	Phillips screw blade	1
99125	Slotted screw blade	1

Cat No.	UPC No.	Qty.
99811	Slotted screw blade	1
99250	Slotted screw blade	1
99312	Slotted screw blade	1
996	Hex nutdriver blade	1
998	Hex nutdriver blade	1
9910	Hex nutdriver blade	1
9911	Hex nutdriver blade	1
9912	Hex nutdriver blade	1
9914	Hex nutdriver blade	1
9916	Hex nutdriver blade	1

Cat No.	UPC No.	Qty.
43H	Curved nose seizer 6"/152mm	1
46CG	Adjustable wrench 6"/152mm	1
51CG	Long nose pliers 6 1/2"/165mm	1
53CG	Utility pliers 7"/178mm	1
64CG	Diagonal pliers 4"/101mm	1
55CG	Diagonal pliers 5"/127mm	1
57CG	Needle nose pliers 5 1/2"/139mm	1
86CG	Electronic snips	1
101S	Wire stripper-cutter	1
K22	Electrician's knife	1

Model TCMG200ST and TCMG200MT

- Fine blending of quality, economy and flexibility
- Contains 10 individual hand tools and 27 Series 99® interchangeable screwdriver/nutdriver blades and handles (as listed)
- Durable, double skin blow-molded plastic case
- Size: 13 1/2" x 10 1/2" x 2 3/8"/343mm x 267mm x 60mm



Cat No.	UPC No.	Description
TCMG200ST	037103162731	Tool case with tools
TCMG200MT	037103162748	Tool case only-NO TOOL

Cat No.	UPC No.	Qty.
991	Straight handle	1
994	Tee handle	1
9920 - 9926	Hex socket screw blades(7)	1
99764	Hex socket screw blade	1
99964	Hex socket screw blade	1
9938	Reamer	1
99X5	Extension	1
99820	Phillips screw blade	1
99821	Phillips screw blade	1
99822	Phillips screw blade	1
99125	Slotted screw blade	1

Cat No.	UPC No.	Qty.
99811	Slotted screw blade	1
99250	Slotted screw blade	1
99312	Slotted screw blade	1
996	Hex nutdriver blade	1
998	Hex nutdriver blade	1
9910	Hex nutdriver blade	1
9911	Hex nutdriver blade	1
9912	Hex nutdriver blade	1
9914	Hex nutdriver blade	1
9916	Hex nutdriver blade	1

Cat No.	UPC No.	Qty.
43H	Curved nose seizer 6"/152mm	1
46CG	Adjustable wrench 6"/152mm	1
51CG	Long nose pliers 6 1/2"/165mm	1
53CG	Utility pliers 7"/178mm	1
64CG	Diagonal pliers 4"/101mm	1
55CG	Diagonal pliers 5"/127mm	1
57CG	Needle nose pliers 5 1/2"/139mm	1
86CG	Electronic snips	1
101S	Wire stripper-cutter	1
K22	Electrician's knife	1

DataCom Cutters and Slitters



Limited Lifetime Warranty

CooperTools warrants this product will be free from defects in material and workmanship for as long as you own this product, provided that no warranty is made with respect to products which have been (a) altered, modified or repaired by anyone other than CooperTools; (b) subject to abuse, improper use, negligence, accident or improper storage; (c) installed, used or maintained not in accordance with normal practices or the instructions and specifications of CooperTools; or (d) used in conjunction with any product, device, component or system, that is either defective, the source of a defect, or not reasonably intended to be used in conjunction with this product.

The foregoing limited warranty is exclusive and in lieu of all other warranties, whether express, implied or statutory, including, but not limited to, any warranty of merchantability or fitness for any particular purpose. The obligation of CooperTools under this limited warranty is expressly limited to either repairing the product, refunding the purchase price or replacing the product, at the sole and absolute discretion of CooperTools, at no charge to Buyer.

The remedies provided for herein shall constitute the sole recourse of Buyer against CooperTools, whether the claim is made in tort or in contract, including claims based on warranty, negligence, strict liability, deceit, fraud, misrepresentation or otherwise. In no event shall CooperTools be liable for special, indirect, incidental or consequential damages (regardless of the form of action), nor for lost profits. CooperTools liability for any claims or damages arising out of or connected with the manufacture, sale, delivery, use, maintenance, repair or modification of this product shall not exceed its purchase price.

CooperTools will, during the warranty period, repair, replace or refund the purchase price of any product found to be defective in accordance with this limited warranty. Return to CooperTools, 1000 Lufkin Road, Apex, NC 27502. All costs of transportation shall be borne by the Buyer.

Telecom Cutter



- Can cut up to 100 pair group cable
- Cuts coaxial cable up to RG174/RG9
- Built-in return spring allows ease of use
- Cushion grip handles for comfortable use
- Safety lock keeps tool closed in tool pouch
- Frame is made of stamped hardened carbon steel for durability and long life

Cat No.	UPC No.	Packed	Description	Pack Wt.		Shelf Pack
				lb	g	
DCC100V	037103184924	Carded	Cutter, Telecom	4.08	116	6

Coax Cable Cutter



- Cuts coaxial cable up to RG9
- Cuts soft copper cable – will not cut steel reinforced cable
- The uniform flush cutting action maintains cable integrity
- Cushion grip handles for comfortable use
- Safety lock keeps tool closed in tool pouch
- Frame is made of stamped hardened carbon steel for durability and long life

Cat No.	UPC No.	Packed	Description	Pack Wt.		Shelf Pack
				lb	g	
DCC101V	037103184863	Carded	Cutter, coax	1.56	44	6

Fiber Optic Cutter

- Specially designed for cutting Kevlar "silks" in fiber optic cable
- Hard molded plastic frame for durability and long life
- Special ceramic blades cut Kevlar cleanly
- Light weight for ease of use



Cat No.	UPC No.	Packed	Description	Pack Wt.		Shelf Pack
				lb	g	
DCC102V	037103184894	Carded	Cutter, Fiber Optic, Ceramic Blades	0.60	17	6

Round Cable Slitter

- Runs a slit around the circumference and down the length of coaxial cable to easily remove the jacket
- Adjustable blade can be used on multiple and single conductor cable 4mm to 25mm O.D.
- Slitting blade is adjustable up to a depth of 0.125" (3mm)
- Spare blades store in handle of tool for easy access



Cat No.	UPC No.	Packed	Description	Pack Wt.		Shelf Pack
				lb	g	
DCS200V	037103184870	Carded	Slitter, Round Cable, 4mm - 25mm	1.86	53	6
DCS205V	037103185280	Carded	Blades, Replacement for DCS200V and DCS204V, 6/Pkg	0.18	5	6

Round Cable Slitter

- For slitting and ringing round cable 25 mm to 36 mm in diameter
- Slitting blade can be adjusted up to 0.125" (3 mm) depth
- Spare blade is stored in handle for convenience



Cat No.	UPC No.	Packed	Description	Pack Wt.		Shelf Pack
				lb	g	
DCS204V	037103184962	Carded	Slitter, Round Cable, 25mm - 36mm	1.92	54	6
DCS205V	037103185280	Carded	Blades, Replacement for DCS200V and DCS204V	0.18	5	6

Self-adjusting Wire Stripper



- Blades automatically adjust to strip 10 – 28 AWG insulated copper wire so you can use one tool regardless of the wire gauge
- Replaceable metal jaws with 68 teeth (34 on each side)
- Individual stripping blades for concise strip
- Strips outer jacket and inner conductors without nicking insulation or cables
- Tension adjustments for insulation thickness & handle tension allowing comfortable ease of use
- Strong Glass-Fiber reinforced body for durability and long life
- Built in cutter for flat (up to 4 pair) and round cable (up to RG59) to give you added utility with one tool

Cat No.	UPC No.	Packed	Description	Pack Wt.		Shelf Pack
				lb	g	
DCS201V	037103184900	Carded	Stripper, Self-adjusting	1.86	53	6
DCS206V	037103185297	Carded	Jaws, Replacement, for DCS201V	0.18	5	6
DCS207V	037103185303	Carded	Blades, Replacement for DCS201V	0.18	5	6

Rotary Coax Stripper



- Fast, accurate coax stripping system helps you get the job done efficiently
- Cassette contains three stripping blades for a 3-step strip of coaxial cable
- Blades can be removed for 2-strep or 1-step strips
- Blades can be moved within the cassette in 2mm intervals so you can adjust to your needs
- Cassette is replaceable to extend tool life (order number DCD400V)

Cat No.	UPC No.	Packed	Description	Pack Wt.		Shelf Pack
				lb	g	
DCS202V	037103184917	Carded	Stripper, Rotary Coax	0.66	19	6
DCS400V	037103184931	Carded	Cassette, 3-Step, DCS202V	0.18	5	6

UTP/STP Stripper

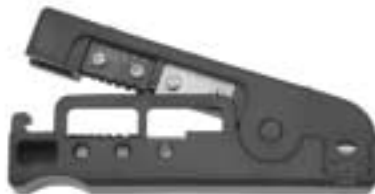

- Use on shielded twisted pair and unshielded twisted pair, CATV Cable, CB Antenna, SO, SJ, SJT and other flexible cables
- Strips coax and UTP/STP Cable
- Versatile stripper and cutter allows you to carry fewer tools
- Built-in cutter for clean cuts
- Build-in wire stripper strips 16 – 26 AWG wire for added versatility

Cat No.	UPC No.	Packed	Description	Pack Wt.		Shelf Pack
				lb	g	
DCS203V	037103184948	Carded	Stripper, Stripper, UTP/STP	1.08	31	6
DCS208V	037103185310	Carded	Cassette, DCS203V UTP/STP Stripper	0.24	7	6

Cable Tie Gun

- Die-cast steel construction for durability and long life
- Provides a flush cut with each use for neat, professional installations
- Tension adjustment allows use on miniature, intermediate, standard and heavy - duty cable ties



Cat No.	UPC No.	Packed	Description	Pack Wt.		Shelf Pack
				lb	g	
DCT300V	037103184887	Carded	Gun, Cable Tie	4.02	114	6

"B" Wire Crimp Tool

- Recommended for every data com alarm installer
- Specialty Designed Tool for stripping flat and twisted pair cables
- Crimps "B" Wire, UG, UR, and UY connectors commonly used in Data Com alarm installations
- Special Stop behind cutout prevents damage to connectors
- Cushion grip handles for comfortable use



Cat No.	UPC No.	Packed	Description	Pack Wt.		Shelf Pack
				lb	g	
DCT303V	037103184979	Carded	Crimp Tool, "B" Wire Scotchlock UR	1.68	47.64	6

SOHO Telecom Crimp Tool

- Perfect do-it-yourself tool for single office/home office (SOHO) installations
- Cuts strips and terminates RJ-11, RJ-45, and 4, 6, and 8 position modular plugs making it a true multi-function tool
- Lightweight and easy to use



Cat No.	UPC No.	Packed	Description	Pack Wt.		Shelf Pack
				lb	g	
DCT301V	037103184955	Carded	Crimp Tool, All-in-One Telecom	2.1	60	6

All-in-one Telecom Crimp Tool

- Cuts, strips and crimps RJ11 & RJ45 4, 6 & 8 position modular plugs
- Full cycle ratchet assures precise crimp with each use
- Stamped steel frame with cushion grip handles for durability and ease of use
- Crimps primary and strain relief all in on operation for professional results



Cat No.	UPC No.	Packed	Description	Pack Wt.		Shelf Pack
				lb	g	
DCT311V	037103184993	Carded	Crimp Tool, All-in-One Telecom, Ratchet	6.36	180	6

Telecom Crimp Tool Frame



- Ergonomically designed handle reduces necessary crimp force
- Consistent mechanical gain for reliable connections
- Easily interchangeable dies sets for a wide range of coax and Data Com connectors
- Easy access crimp release for use in the event the tool is jammed

Cat No.	UPC No.	Packed	Description	Pack Wt.		Shelf Pack
				lb	g	
DCT302V	037103184986	Carded	Frame, Telecom Crimp Tool, No Die Set	6.18	175	6

Die Sets



For use with DCT302V Telecom Crimp Tool Frame

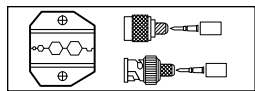

DCD410V

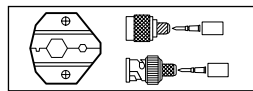

DCD414V

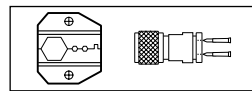

DCD418V

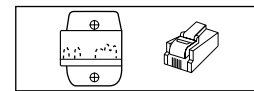

DCD422V

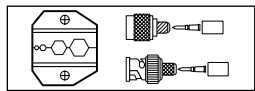

DCD411V

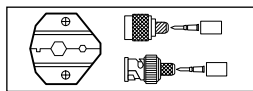

DCD415V

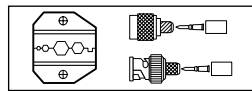

DCD419V

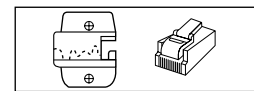

DCD423V

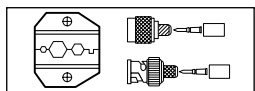

DCD412V

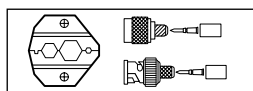

DCD416V

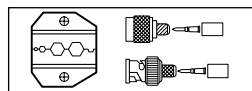

DCD410V

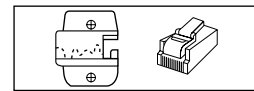

DCD424V

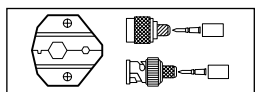

DCD413V

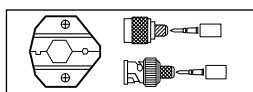

DCD417V

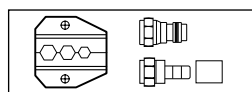

DCD421V

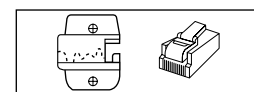

DCD425V

Cat. No.	UPC No.	Packed	Use For	Cavities	Hex Size (in.)	Pack Wt.		Shelf Pack
						Lb.	g	
DCD410V	037103185129	Carded	RG-58, RG-174, RG-8218 for 50 and 75 Ohm Cables	4	0.213, 0.178, 0.068, 0.042	0.84	24	6
DCD411V	037103185136	Carded	RG-59, RG-6, RG-8281	4	0.324, 0.255, 0.068, 0.042	0.84	24	6
DCD412V	037103185143	Carded	RG-58, RG-59/62 BNC/TNC	3	0.255, 0.213, 0.068	0.84	24	6
DCD413V	037103185150	Carded	RG58, BNC/TNC Coax	2	0.213, 0.068	0.84	24	6
DCD414V	037103185167	Carded	RG59/62 AU BNC/TNC Coax	2	0.255, 0.068	0.84	24	6
DCD415V	037103185174	Carded	RG174 BNC/TNC Coax	2	0.178, 0.068	0.84	24	6
DCD416V	037103185181	Carded	RG58 and RG59/62 AU BNC/TNC Coax	3	0.213, 0.255, 0.068	0.84	24	6
DCD417V	037103185198	Carded	Belden Type, RG8281 and RG6 BNC/TNC Coax	2	0.324, 0.068	0.84	24	6
DCD418V	037103185204	Carded	Twinax	3	0.429, 0.075, 0.075	0.84	24	6
DCD419V	037103185211	Carded	RG-58/59, Plenum & Teflon cables	4	0.213, 0.019, 0.068, 0.042	0.84	24	6
DCD420V	037103185228	Carded	Mini BNC/TNC	5	0.052, 0.068, 0.100, 0.213, 0.255	0.84	24	6
DCD421V	037103185235	Carded	RG-59, RG-6, F-type CATV	3	0.250, 0.320, 0.255	0.84	24	6
DCD422V	037103185242	Carded	RJ-11 Telecom plug	N/A	N/A	0.84	24	6
DCD423V	037103185259	Carded	RJ-45 Ten Position Telecom Plug	N/A	N/A	0.84	24	6
DCD424V	037103185266	Carded	RJ-45 8 Position Telecom Plug	N/A	N/A	0.84	24	6
DCD425V	037103185273	Carded	RJ-45 8 position, AMP style Telecom Plug	N/A	N/A	0.84	24	6

Punch Down Tools



DCT304V



DCT306V



DCT307V



DCT308V



DCT305V



- Cuts and terminates simultaneously for ease of use
- High & low impact adjustments accommodates volume installers and occasional users
- Storage compartment for spare blade is convenient
- Accommodates blades for 66, 110, and Krone style blocks
- Quick-release push button blade release so you can change blades fast
- Comes with one blade for type 66 block

- Cuts and terminates simultaneously for ease of use
- Quick-release push button blade release so you can change blades fast
- Blades are interchangeable with DCT305V Impact tool so you don't have to maintain separate blade styles
- Comes with one blade for type 66 block

Cat No.	UPC No.	Packed	Description	Pack Wt.		Shelf Pack
				lb	g	
DCT304V	037103185006	Carded	Punch Down Tool Impact w/ Type 66 blade	1.74	49	6
DCT305V	037103185013	Carded	Punch Down Tool Non-Impact w/ Type 66 blade	1.68	48	6
DCT306V	037103185044	Carded	Blade, Punch Down, Type 66	0.30	9	6
DCT307V	037103185082	Carded	Blade, Punch Down, Type 110	0.30	9	6
DCT308V	037103185099	Carded	Blade, Punch Down, Krone Type	0.30	9	6

Double End Can Wrench

- 3/8" and 7/16" double end nutdrivers for opening telecommunications cabinets and pedestals
- Use to place fuses in cable terminals and connect wires to fuses and binding post
- Durable plastic handle for years of use



Cat No.	UPC No.	Packed	Description	Pack Wt.		Shelf Pack
				lb	g	
DCT309V	037103185105	Carded	Can Wrench, 3/8" & 7/16" Hex Double End	1.44	41	6

Exterior CATV Crimp Tool

- For use on SNS59/59QS/59HEC & SNS6/6QS Snap-N-Seal™ Security Shield connectors
- Makes an efficient and accurate crimp every time for ease of use



Cat No.	UPC No.	Packed	Description	Pack Wt.		Shelf Pack
				lb	g	
DCT310V	037103185112	Carded	Crimp Tool, Exterior Weatherproof of CATV	5.94	168	6

COAX/Data/Tone Tester



Uses: The CDD1B cable tester is a convenient instrument for testing different unshielded wiring schemed telephone cable with RJ-11 and RJ-45 connectors as well as coax cable.

Features and benefits

- Mapping function allows you to test cable conditions before or after installation
- Cable location/identification function allows you to identify the locations of up to seven installed cables. Seven remote identifiers (labeled A through G) are included
- Testing functions include cable identification (straight or reverse), pair identification, and open/short test
- Low battery indicator light indicates the condition of the 9-volt battery (battery included)
- Tester turns off automatically to save battery power
- Lifetime warranty (see page 490 for details)

Cat No.	UPC No.	Packed	Description	Pack Wt.		Shelf Pack
				lb	g	
CDD1B	037103187031	Boxed	COAX/Data/Tone Tester	0.37	10	1

Telecom Data Tester



Uses: Quickly verifies the condition of wiring (up to 1,500 feet) in patch cords and coaxial cables not installed through walls or bulkheads (Both cable ends must be plugged into the tester).

Features and benefits

- Uses both speech and lights to indicate cable conditions. No need to interpret the lighting sequence. A voice module announces the results
- Identifies open, short, and good cables so you can correct a mistake before installation
- Checks both F-type and BNC (adapter required) coaxial cables
- Checks RJ-11 and RJ-45 telephone cables
- Low battery indicator light indicates the condition of the 9-volt battery (battery included)
- Only uses power during the test – conserves battery life
- Lifetime warranty (see page 490 for details)

Cat No.	UPC No.	Packed	Description	Pack Wt.		Shelf Pack
				lb	g	
TDT1	037103185341	Carded	Telecom data Tester	0.30	9	1

Professional Telephone Test Set



Uses: Used by installers and repair technicians for line testing and temporary communications.

Features and benefits

- Test set features a mega ohm (mW) meter for testing insulation resistance and telephone capacity. Technician can determine line conditions (faults) without assistance from the central office (CO)
- Integrated circuit design provides for both DTMF (touch-tone) and dial pulse output
- Numerous functions allow for convenient use: talk function, last number redial, hook and flash, speaker phone, mute, and polarity checking
- A high impedance monitor mode allows you to monitor a line without disruption to conversation, data transfer, or signaling
- Waterproof so it can be used in adverse weather conditions
- Cord utilizes a piercing pin and angled bed on nails (ABN) style connector so you can make reliable connections
- The BS100 is made of high impact material, providing excellent insulating properties and shock resistance
- Operates on a 9-volt battery (battery included)
- Lifetime warranty (see page 490 for details)

Cat No.	UPC No.	Packed	Description	Pack Wt.		Shelf Pack
				lb	g	
BS100	037103185372	Boxed	Professional Telephone Test Set	1.45	41	1

Tone Generator

- Used to identify termination point of a communications cable
- Use in conjunction with the TSTP1 amplifier probe for quick and easy pair identification with audible verification
- Generates either single or dual tone signals depending on the line type
- Can generate a tone across both telecom and coax cable using either the test leads or the four conductor modular plug
- Will generate a tone through low resistance circuits up to 20,000 feet in length
- Use in conjunction with BS100 handset to verify cable continuity
- Weather resistant
- Operates on a 9-volt battery (battery included)
- Lifetime warranty (see page 490 for details)



Cat No.	UPC No.	Packed	Description	Pack Wt.		Shelf Pack
				lb	g	
TSTG1A	037103185358	Carded	Tone Generator	0.40	11	1
DCK14	037103186607	Boxed	Tone Generator/Amplifier Kit with Leather Case	0.78	22	1

Amplifier Probe

- Used to identify termination point of a communications cable
- Use in conjunction with TSTG1A tone generator for quick and easy pair identification
- Audible verification on either single, twisted pair, or coax cable (adjustable volume)
- Weather resistant
- Operates on a 9-volt battery (battery included)
- Lifetime warranty (see page 490 for details)



Cat No.	UPC No.	Packed	Description	Pack Wt.		Shelf Pack
				lb	g	
TSTP1	037103185365	Carded	Amplifier Probe	0.18	5	1
DCK14	037103186607	Boxed	Tone Generator/Amplifier Kit with Leather Case	0.78	22	1

Telephone Line Analyzer

Uses: Quickly and accurately identifies reversed, open, and shorted telephone lines by plugging directly into the wall jack.

Features and benefits

- Has leads for both RJ-11 and RJ-45 modular telephone jacks. Can be used on most residential and commercial phone lines
- Four LED lights so you can identify correct wiring, reverse polarity, shorted or open pairs quickly and accurately
- Lifetime warranty (see page 486 for details)



Cat No.	UPC No.	Packed	Description	Pack Wt.		Shelf Pack
				lb	g	
TWT1	037103185389	Carded	Telephone Line Analyzer	0.66	19	6

F-Type Termination Kit



Kit contents:

DCT302V Telecom crimp tool frame, DCD421V die set for RG-59, F-type CATV, and RG-6; DCS202V rotary coax stripper, DCC101V coax cutter, 25 RG-58 F-connectors, 25 RG-59 F-connectors, black Cordura® case.

Kit includes black Cordura® roll-up case - See page 502

Cat No.	UPC No.	Packed	Description	Pack Wt.		Shelf Pack
				lb	g	
DCK1	037103186478	Boxed	Basic F-Type Termination Kit	1.63	46	1

Twist-on F-Connector Kit



Kit contents:

DCC101V coax cutter, DCS202V rotary coax stripper, 25 RG-59 twist-on F-connectors, black Cordura case.

Kit includes black Cordura roll-up case - See page 502

Cat No.	UPC No.	Packed	Description	Pack Wt.		Shelf Pack
				lb	g	
DCK2	037103186485	Boxed	Twist-on F Connector Kit	0.72	20	1

Basic Telecom Kit



Kit contents:

DCC100V Telecom cutter, TDT1 SOHO line analyzer, DCT311V All-in-one ratcheting telecom crimp tool, 25 each of 4, 6, and 8 position telecom plugs, black Cordura case.

Kit includes black Cordura roll-up case - See page 502

Cat No.	UPC No.	Packed	Description	Pack Wt.		Shelf Pack
				lb	g	
DCK3	037103186492	Boxed	Basic Telecom Kit	2.89	82	1

Coax Telecom Connector Kit

Kit contents:

DCT302V Telecom crimp tool frame, DCD412V RG-58, RG-59/62 BNC/TNC die set, DCT311V All-in-one ratcheting telecom crimp tool, DCC101V coax cutter, TDT1 SOHO line analyzer, DCS202V rotary coax stripper, assorted telecom plugs and coax connectors, black Cordura case.



Kit includes black Cordura case - See page 502

Cat No.	UPC No.	Packed	Description	Pack Wt.		Shelf Pack
				lb	g	
DCK4	037103186508	Boxed	Coax Telecom Connector Kit	3.40	96	1

SOHO Cable Installers Kit

Kit contents:

DCC101V coax cutter, XP2 1-speed cordless screwdriver and charger (not shown), DCT311V All-in-one telecom ratchet crimp tool, DCT302V telecom crimp tool frame, DCD412V RG-58, RG-59/62 BNC/TNC die set, DCD421V die set for RG-59, F-type CATV, and RG-6; DCT309V double end hex can wrench, TWT1 telephone line analyzer, TDT1 SOHO line analyzer, assorted telecom plugs and coax connectors, black Cordura case.



Kit includes black Cordura case - See page 502

Cat No.	UPC No.	Packed	Description	Pack Wt.		Shelf Pack
				lb	g	
DCK5	037103186515	Boxed	SOHO Cable Installers Kit	6.22	176	1

Professional Installers Kit

Kit contents:

DCC101V coax cutter, XP2 1-speed cordless screwdriver and charger, DCT311V All-in-one telecom ratchet crimp tool, DCT302V telecom crimp tool frame, DCD412V RG-58, RG-59/62 BNC/TNC die set, DCD421V die set for RG-59, F-type CATV, and RG-6; DCT309V double end hex can wrench, TWT1 telephone line analyzer, TDT1 SOHO line analyzer, DCS203V UTP/STP stripper, DCS201V self-adjusting stripper, FSD1 4 in one screwdriver, DCT300V cable tie gun, CDD1B coax/data/tone tester, BS100 test set, DCT304V impact punch down tool, (10) DCT306V type 66 blades, (10) type 110 blades, TSTG1A tone generator, TSTP1 amplifier probe, assorted telecom plugs and coax connectors, black Cordura case.



Kit includes black Cordura case - See page 502

Cat No.	UPC No.	Packed	Description	Pack Wt.		Shelf Pack
				lb	g	
DCK6	037103186522	Boxed	Professional Installers Kit	11.37	322	1

Twisted Pair Coax Kit



Kit contents:

DCC100V telecom cutter, DCS203V UTP/STP stripper, DCS201V self-adjusting stripper, DCS202V rotary coax stripper, DCT302V telecom crimp tool frame, DCD412V die set for RG-59, F-type CATV, and RG-6; DCT311V all-in-one ratcheting telecom crimp tool, DCT304V impact punch down tool, type 66 blade, type 110 blade, CDD1B coax/data/tone tester, TSTG1A tone generator, TSTP1 amplifier probe, assorted telecom plugs and coax connectors, black Cordura case.

Kit includes black Cordura case - See page 502

Cat No.	UPC No.	Packed	Description	Pack Wt.		Shelf Pack
				lb	g	
DCK7	037103186539	Boxed	Twisted Pair Coax Kit	5.72	162	1

UTP/STP Twisted Pair Coax Kit



Kit contents:

DCC100V telecom cutter, DCS203V UTP/STP stripper, DCS201V self-adjusting stripper, DCS202V rotary coax stripper, DCT302V telecom crimp tool frame, DCD412V die set for RG-59, F-type CATV, and RG-6; DCT311V all-in-one ratcheting telecom crimp tool, DCT304V impact punch down tool, DCT306 type 66 blade, DCT307V type 110 blade, CDD1B coax/data/tone tester, TSTG1A tone generator, TSTP1 amplifier probe, BS100 test set, DCT300V cable tie gun, assorted telecom plugs and coax connectors, black Cordura case.

Kit includes black Cordura case - See page 502

Cat No.	UPC No.	Packed	Description	Pack Wt.		Shelf Pack
				lb	g	
DCK8	037103186546	Boxed	UTP/STP Twisted Pair Coax Kit	7.94	225	1

Category 5 Data/Voice Kit



Kit contents:

DCC100V telecom cutter, DCS203V UTP/STP stripper, DCT302V telecom crimp tool frame, DCD422V, RJ-11 die set, DCD425V RJ-45 8 pos. AMP style die set, CDD1B coax/data/tone tester, DCT304V impact punch down tool, DCT306V type 66 blade, DCT307V type 110 blade, BS100 test set, TSTG1A tone generator, TSTP1 amplifier probe, assorted telecom plugs, black Cordura case.

Kit includes black Cordura case - See page 502

Cat No.	UPC No.	Packed	Description	Pack Wt.		Shelf Pack
				lb	g	
DCK9	037103186533	Boxed	Category 5 Data/Voice Kit	5.91	167	1

SOHO Coax/Telecom Test kit

Kit contents:

TDT1 SOHO line analyzer, TWT1 telecom wall plate tester, black Cordura case.



Kit includes black Cordura roll-up case - See page 502

Cat No.	UPC No.	Packed	Description	Pack Wt.		Shelf Pack
				lb	g	
DCK10	037103186560	Boxed	SOHO Coax/Telecom Test Kit	0.95	27	1

Pro Coax/Data/Telecom/Test Kit

Kit contents:

CDD1B coax/data/tone tester, TSTG1A Tone Generator, TSTP1 amplifier probe, BS100 test set, black Cordura case.



Kit includes black Cordura case - See page 502

Cat No.	UPC No.	Packed	Description	Pack Wt.		Shelf Pack
				lb	g	
DCK11	037103186577	Boxed	Pro Coax/Data/Telecom Test Kit	2.65	75	1

Network Maintenance Kit

Kit contents:

XP1 cordless screwdriver w/charger, battery, and four bits; CDD1B coax/data/tone tester, TSTG1A tone generator, TSTP1 amplifier probe, BS100 test set, DCT311V all-in-one telecom ratcheting crimp tool, DCS201V self-adjusting wire stripper, black Cordura case.



Kit includes black Cordura case - See page 502

Cat No.	UPC No.	Packed	Description	Pack Wt.		Shelf Pack
				lb	g	
DCK12	037103186584	Boxed	Network Maintenance Kit	6.49	184	1

Exterior Waterproof CATV Connector Kit



Kit contents:

DCT310V exterior weatherproof CATV crimp tool, DCC100V telecom cutter, 25 Snap-N-Seal™ Connectors, black Cordura case.

Kit includes black Cordura roll-up case - See page 502

Cat No.	UPC No.	Packed	Description	Pack Wt.		Shelf Pack
				lb	g	
DCK13	037103186591	Boxed	Exterior Waterproof CATV Connector Kit	2.17	62	1

Tone/Generator/Amplifier Kit



Kit contents:

TSTG1A tone generator, TSTP1 amplifier probe, black leather case.

See page 497 for features and benefits.

Kit includes black leather case (not pictured)

Cat No.	UPC No.	Packed	Description	Pack Wt.		Shelf Pack
				lb	g	
DCK14	037103186607	Boxed	Tone Generator/Amplifier Kit	0.78	22	1

Black Cordura® Cases for Each Kit



Black Cordura Case



Black Cordura Roll-up Case

Tools for Cable Terminals and Connectors

Xcelite® ErgoCrimp® and ErgoCrimp Plus® Mechanical Crimping Tools

- ErgoCrimp® and ErgoCrimp Plus® are the world's most advanced crimping tools to date
- With a new patented design, they deliver up to 50% better mechanical gain than any other kind
- With increased mechanical gain you will get significantly lower handle force which could result in an increase in productivity
- ErgoCrimp tools can be purchased by themselves (without dies) or in conjunction with any combination of the die sets
- Special dies are also available upon request

These crimping tools have been designed to achieve maximum comfort, reliability, and durability.

Their main features are:

One-Handed Crimping

- The handle force needed for the crimping operation in most tools exceeds 60-70lbs. (27-32Kg)
- The average man and virtually all women cannot make a comfortable one-handed crimp
- Xcelite® crimping tools are designed with such a low handle force requirement that the crimp operation can be performed with only one hand

Crimping Pressure

- The configurations of the crimping nests and indentors are designed to increase the tensile strength of the crimp
- The jaw pressure applies is scientifically calculated for optimum connections

Reliability

- All components are made of high-quality Swedish steel and have been life tested for 50,000 cycles
- Precision manufacturing guarantees a uniform product of high accuracy
- After long wear, it is always possible to check the crimp dimensions with go/no-go gauges, and to adjust for eventual discrepancies by turning the patented excenter adjustment plate

Size

- Size has been minimized to allow single-handed operation and to ensure the tool fits easily into repair kits

Safety

- A ratchet device has been built in to guarantee that the user makes the exact same complete crimp every time
- Should the user start a faulty crimp, a safety release mechanism is built into the ratchet, allowing the user, with one finger, to open the tool before the cycle is complete

Economy

- Because of their considerable advantages in quality, speed, and efficiency, the payoff time for an investment in Xcelite® tools is extremely short

ErgoCrimp® (EC-000 Frame)
 Length: 8.66"
 Weight: 1.1lbs.

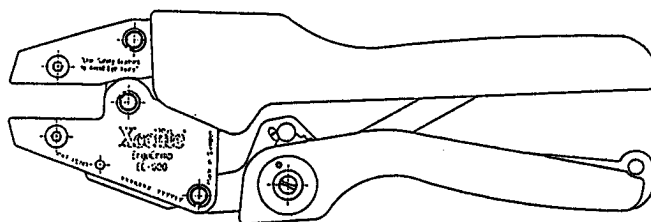

ErgoCrimp Plus® (ECP-000 Frame)
 Length: 10.0"
 Weight: 1.2lbs.

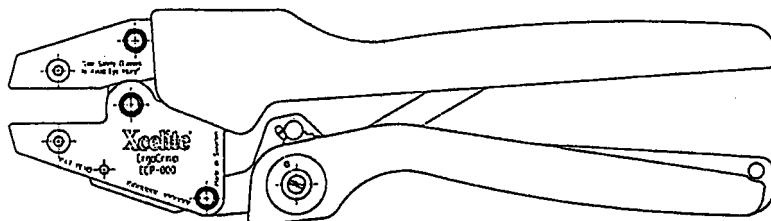

ErgoCrimp Plus® for 22-10 AWG Insulated Terminals and Splices



- ECP000 large ergonomic frame for large hands
- D100 die set for 22-10 AWG red, blue and yellow insulated terminals and splices
- Mechanical gain estimated 50%
- Guaranteed for at least 50,000 cycles
- Variety of die sets available



Cat No.	UPC No.	Packed	Description	Pack Wt.		Shelf Pack
				lb	kg	
ECP100	037103059307	Boxed	ECP000 frame and D100 die set	1.2	0.54	1
D100	037103059345	Boxed	Die set for ECP100	-	-	1

ErgoCrimp® for 30-20 AWG Open-barrel and D-subminiature Contacts



- EC000 ergonomic frame for small hands
- D108 die set for 30-20 AWG open-barrel and D-subminiature contacts
- Mechanical gain estimated 25%
- Guaranteed for at least 50,000 cycles
- Variety of die sets available

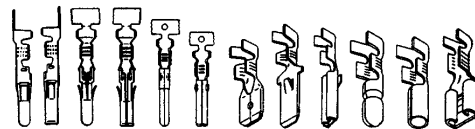

Cat No.	UPC No.	Packed	Description	Pack Wt.		Shelf Pack
				lb	kg	
EC108	037103059284	Boxed	EC000 frame and D108 die set	1.1	0.50	1
D108	037103059420	Boxed	Die set for EC108	-	-	1

ErgoCrimp® for RG58, RG59/62 AU BNC/TNC coaxial connectors



- EC000 ergonomic frame for small hands
- D102 die set for RG 58, RG 59/62 AU BNC/TNC coaxial connectors
- Mechanical gain estimated 25%
- Guaranteed for at least 50,000 cycles
- Variety of die sets available

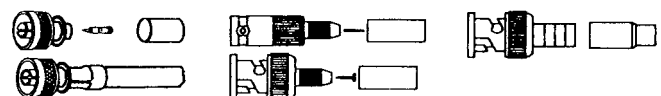

Cat No.	UPC No.	Packed	Description	Pack Wt.		Shelf Pack
				lb	kg	
EC102	037103059314	Boxed	EC000 frame and D102 die set	1.1	0.50	1
D102	037103059369	Boxed	Die set for EC102	-	-	1

ErgoCrimp® Crimping Tool Kit

- EC000 small ergonomic frame
- Series of RG 58-59 AU BNC/TNC coaxial connectors
- D102 die set for RG 58, RG 59/62 AU BNC/TNC coaxial connectors
- Sturdy plastic case



Cat No.	UPC No.	Packed	Description	Pack Wt.		Shelf Pack
				lb	kg	
ECKIT	037103059291	Boxed	Crimping tool kit	2.30	1.04	1

Frame only - ErgoCrimp Plus® Crimping Tool

- Large ergonomic frame for large hands
- Length 10"
- Width 2.83"
- Used with D100 through D109 die sets



Cat No.	UPC No.	Packed	Description	Pack Wt.		Shelf Pack
				lb	kg	
ECP000	037103059338	Boxed	ErgoCrimp Plus® crimping tool-large	1.00	0.45	1

Frame Only - ErgoCrimp® Crimping Tool

- Small ergonomic frame for small hands
- Length 8.66"
- Width 2.83"
- Used with D100 through D109 die sets



Cat No.	UPC No.	Packed	Description	Pack Wt.		Shelf Pack
				lb	kg	
EC000	037103059321	Boxed	ErgoCrimp® crimping tool-small	0.80	0.36	1

ErgoCrimp® Die Set for Insulated Terminals and Splices

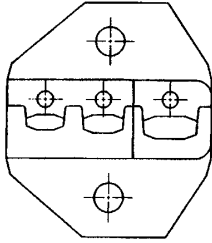

- For 22-10 AWG red, blue and yellow insulated terminals and splices
- Precision-machined hardened steel
- Fits ErgoCrimp® and ErgoCrimp Plus® tools



Cat No.	UPC No.	Packed	Description	Shelf Pack
D100	037103059345	Boxed	Die set	1

ErgoCrimp® Die Set for Non-insulated Terminals and Splices

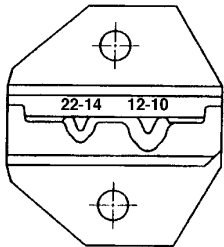

- For 22-10 AWG non-insulated terminals and splices
- Precision-machined hardened steel
- Fits ErgoCrimp® and ErgoCrimp Plus® tools



Cat No.	UPC No.	Packed	Description	Shelf Pack
D101	037103059352	Boxed	Die set	1

ErgoCrimp® Die Set for RG58, RG59/62 AU BNC/TNC Coaxial Connectors

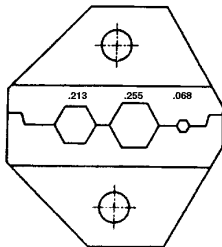

- For RG 58, RG 59/62 AU BNC/TNC - .213", .255" and .068" hex cavities
- Precision-machined hardened steel
- Fits ErgoCrimp® and ErgoCrimp Plus® tools

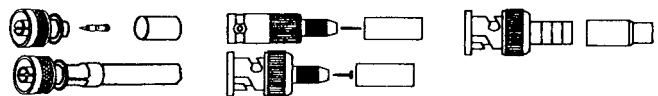

Cat No.	UPC No.	Packed	Description	Shelf Pack
D102	037103059369	Boxed	Die set	1

ErgoCrimp® Die Set for RG58, RG174, 50 and 75ohm Coaxial Connectors

- For RG 58, RG 174, 50 and 75 ohm center contacts - .213", .178" and .068" hex cavities
- Precision-machined hardened steel
- Fits ErgoCrimp® and ErgoCrimp Plus® tools

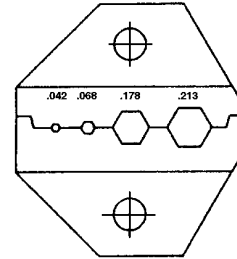
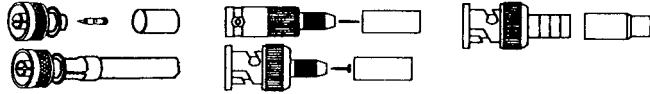

Cat No.	UPC No.	Packed	Description	Shelf Pack
D103	037103059376	Boxed	Die set	1

ErgoCrimp® Die Set for RG59, Belden® 8281, 50 and 75 ohm Coaxial Connectors

- For RG 59, Belden® 8281, 50 and 75 ohm center contacts - .324", .255", .068" and .042" hex cavities
- Precision-machined hardened steel
- Fits ErgoCrimp® and ErgoCrimp Plus® tools
- Belden® is a registered trademark of BELDEN, INC.

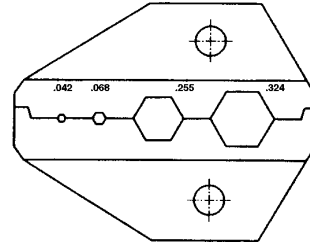
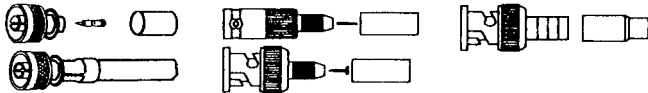

Cat No.	UPC No.	Packed	Description	Shelf Pack
D104	037103059383	Boxed	Die set	1

ErgoCrimp® Die Set for RG174 BNC/TNC Coaxial Connectors

- For RG 174 BNC/TNC - .178", .128", and .068" hex cavities
- Precision-machined hardened steel
- Fits ErgoCrimp® and ErgoCrimp Plus® tools

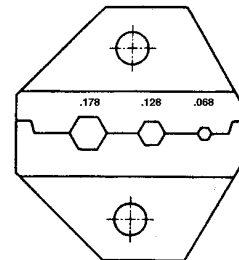
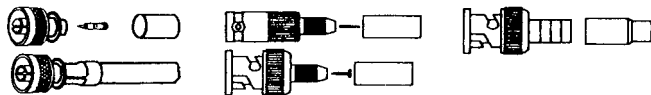

Cat No.	UPC No.	Packed	Description	Shelf Pack
D105	037103059390	Boxed	Die set	1

ErgoCrimp® Die Set for RG8, RG11, RG213, RG216 Coaxial Connectors

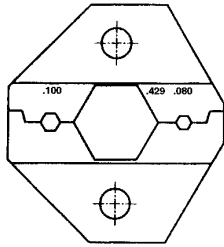

- For RG 8, RG 11, RG 213 and RG 216 ethernet N-series, .429", .100" and .080" hex cavities
- Precision-machined hardened steel
- Fits ErgoCrimp® and ErgoCrimp Plus® tools

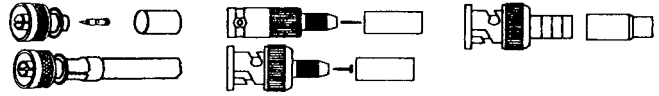

Cat No.	UPC No.	Packed	Description	Shelf Pack
D106	037103059444	Boxed	Die set	1

ErgoCrimp® Die Set for RG59, RG6 CATV Coaxial Connectors

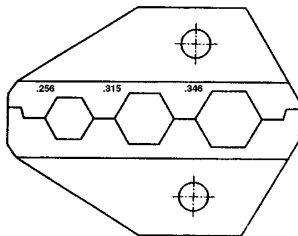

- For RG 59, RG 6 CATV "F" connectors - .346", .315", .256" hex cavities
- Precision-machined hardened steel
- Fits ErgoCrimp® and ErgoCrimp Plus® tools

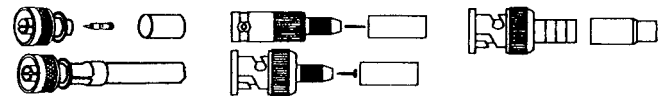

Cat No.	UPC No.	Packed	Description	Shelf Pack
D107	037103059413	Boxed	Die set	1

ErgoCrimp® Die Set for Open-barrel & D-subminiature Contacts

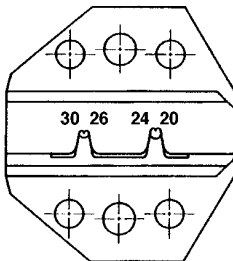

- For 30-20 AWG open-barrel and D-sub-miniature pin and pocket contacts
- Precision-machined hardened steel
- Fits ErgoCrimp® and ErgoCrimp Plus® tools

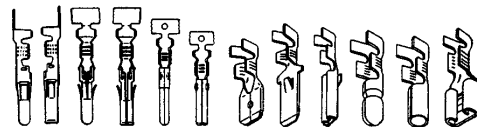

Cat No.	UPC No.	Packed	Description	Shelf Pack
D108	037103059420	Boxed	Die set	1

ErgoCrimp® Die Set for SMA/SFR Fiber Optic Connectors

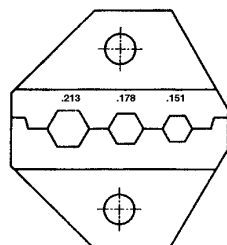

- For SMA/SFR fiber optic connectors requiring .213", .178", .151" hex crimps
- Precision-machined hardened steel
- Fits ErgoCrimp® and ErgoCrimp Plus® tools

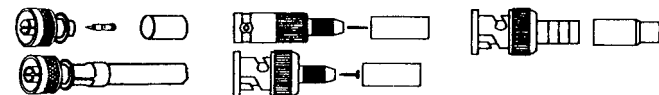

Cat No.	UPC No.	Packed	Description	Shelf Pack
D109	037103059437	Boxed	Die set	1

Mini-Crimper/Maxi-Crimper Mechanical Crimping Tools

Xcelite® mechanical crimping tools have been designed to achieve maximum comfort, reliability, and durability. Their main features are:

One-handed Crimping

- The handle force needed for the crimping operation in most tools exceeds 60-70lbs. (27-32Kg)
- The average man and virtually all women cannot make a comfortable one-handed crimp
- Xcelite® crimping tools are designed with such a low handle force requirement that the crimp operation can be performed with only one hand

Handle Spread

- Other crimping tools on the market have open handle spreads equal to or greater than 6" at the point where the user places his grip
- This is too great a spread for the average male and female hand
- The Xcelite® mini-crimper has a handle spread of about 3 1/2"/88mm
- It is the smallest spread available in a tool this powerful
- The maxi-crimper, with about 20% more power, still has a handle spread under 4 1/2"/144mm
- Both tools fit comfortably in the average male or female hand
- With just one hand needed to hold the crimping tool, the user is now free to easily locate cable and connector in the jaw of the tool

Crimping Pressure

- The configurations of the crimping nests and indentors are designed to increase the tensile strength of the crimp
- The jaw pressure applied is scientifically calculated for optimum connections

Mini-crimper (MIC)

Length: 7.68"
 Weight: 0.55lbs.
 Open Handle Spread: 3.66"
 Closed Handle Spread: 1.90"
 Max. Crimp Force: 1,600lbs.

Maxi-crimper (MAC)

Length: 8.86"
 Weight: 1.10lbs.
 Open Handle Spread: 4.50"
 Closed Handle Spread: 2.10"
 Max. Crimp Force: 2,200lbs.

Reliability

- All components are made of high-quality Swedish steel and have been life tested for 50,000 cycles
- Precision manufacturing guarantees a uniform product of high accuracy
- After long wear, it is always possible to check the crimp dimensions with go/no-go gauges, and to adjust for eventual discrepancies by turning the patented excenter adjustment plate

Size

- Size has been **minimized** to allow single-handed operation and to ensure the tool fits easily into repair kits

Safety

- A ratchet device has been built in to guarantee that the user makes the exact same complete crimp every time
- Should the user start a faulty crimp, a safety release mechanism is built into the ratchet, allowing the user, with one finger, to open the tool before the cycle is complete

Economy

- Because of their considerable advantages in quality, speed, and efficiency, the payoff time for an investment in Xcelite® tools is extremely short.

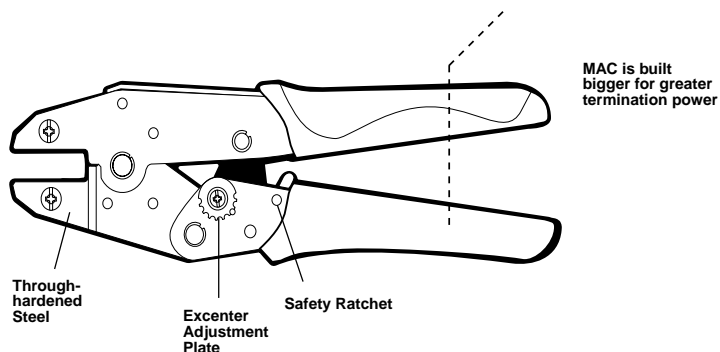
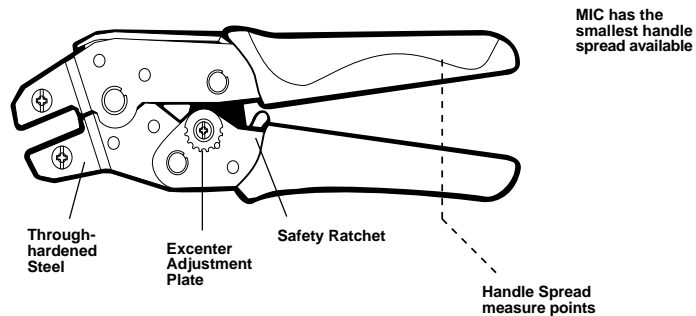

Maxi-Crimper for Insulated Terminals and Splices



- Maxi-Crimper built bigger for greater terminating power
- Crimps 22-10 AWG (.75-6.0mm²) red, blue and yellow insulated terminals and splices (die nests color-coded to AWG specs)
- Incorporates ratchet to ensure a full-cycle complete crimp every time
- Crimps exceed UL® standards for most terminals from AMP, 3M, T & B and many others

Cat No.	UPC No.	Packed	Description	Pack Wt.		Shelf Pack
				lb	kg	
MAC2210	037103489180	Boxed	Maxi-crimper tool	1.1	0.5	1
D2210	037103490186	Boxed	Die set for MAC2210	-	-	1

Mini-Crimper for Insulated Terminals and Splices



- Mini-Crimper smallest professional crimp tool of its kind
- Crimps 22-14 AWG (.75-2.5mm²) red and blue insulated terminals and splices (die nests color-coded to AWG specs)
- Incorporates ratchet to ensure a full-cycle complete crimp every time
- Dies interchangeable with MIC174, MIC58, MIC59, MIC5859
- Crimps exceed UL standards for most terminals from AMP, 3M, T & B and many others

Cat No.	UPC No.	Packed	Description	Pack Wt.		Shelf Pack
				lb	kg	
MIC2214	037103489197	Boxed	Mini-crimper tool	0.55	0.25	1
D2214	037103490193	Boxed	Die set for MIC2214	-	-	1

Mini-Crimper for Non-insulated Terminals and Splices



- Mini-Crimper smallest professional crimp tool of its kind
- Crimps 22-10 AWG (.75-6.0mm²) non-insulated terminals and splices
- Designed to crimp butted, brazed and seamless barrel non-insulated terminals and splices
- Incorporates ratchet to ensure a full-cycle complete crimp every time
- Crimps exceed UL standards for most terminals from AMP, 3M, T & B and many others

Cat No.	UPC No.	Packed	Description	Pack Wt.		Shelf Pack
				lb	kg	
MIC2210	037103490384	Boxed	Mini-crimper tool	0.55	0.25	1

Mini-Crimper for Open Barrel & D-subminiature Contacts

- Mini-Crimper smallest professional crimp tool of its kind
- Universal tool designed to crimp a wide range of open-barrel and D-subminiature contacts 30-20 AWG
- Versatile tool for pins, sockets, disconnects and other open-barrel contacts from AMP, MOLEX, ITT Cannon and others
- Incorporates ratchet to ensure a full-cycle complete crimp every time

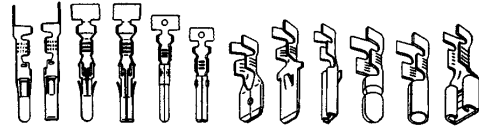

Cat No.	UPC No.	Packed	Description	Pack Wt.		Shelf Pack
				lb	kg	
MIC3020BL	037103490391	Boxed	Mini-crimper tool	0.55	0.25	1

Mini-Crimper for RG58 and RG59 BNC/TNC Coaxial Connectors

- Mini-Crimper smallest professional crimp tool of its kind
- Crimps RG 58 and RG 59 BNC/TNC coaxial connectors to industry standard crimp specifications
- Incorporates ratchet to ensure a full-cycle complete crimp every time
- Dies interchangeable with MIC2214

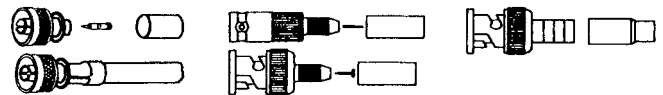

Cat No.	UPC No.	Packed	Description	Pack Wt.		Shelf Pack
				lb	kg	
MIC5859	037103489227	Boxed	Mini-crimper tool	0.55	0.25	1
D5859	037103489265	Boxed	Die set for MIC5859	-	-	1

Maxi-Crimper for Belden® 8281 and RG59 BNC/TNC Coaxial Connectors

- Bigger for greater terminating power
- Crimps BNC/TNC coaxial connectors for both Belden® 8281 and RG 59 coaxial cables
- Ideal for audio, video and broadcast applications using Belden® 8281 and RG 59
- Incorporates ratchet to ensure a full-cycle complete crimp every time
- Belden® is a registered trademark of BELDEN, INC.

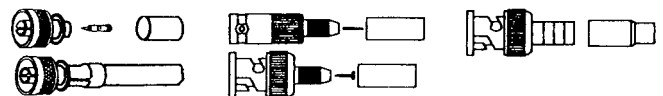

Cat No.	UPC No.	Packed	Description	Pack Wt.		Shelf Pack
				lb	kg	
MAC8259	037103491176	Boxed	Maxi-crimper tool	1.1	0.50	1
D8259	037103491183	Boxed	Die set for MAC-8259	-	-	1

Kit-Modular Plug Crimping Tool



- Contains 1 each of the following: DRJ11, DRJ22, DRJ45, DMMJ die sets and crimping tool frame
- Stored in sturdy plastic case with convenient carrying handle

Cat No.	UPC No.	Packed	Description	Shelf Pack
MIPKIT	037103491473	Boxed	Tool kit	1

Combination, Self-adjusting Wire Stripper



- Body of tough fiberglass-reinforced nylon
- No other self-adjusting wire stripper allows hand that positions cable and hand that cycles tool to work so closely together
- Mechanics made of high quality corrosion-protected special hardened Swedish steel
- Widest cutting and stripping range in 1 tool
- Cuts and strips nylon and PVC insulated cable 30-12 AWG (.05-6.0mm²)
- Ingenious mechanism on Combination Stripper automatically adjusts the holding force on cable
- Combination Stripper also equipped with excellent built-in cutter
- Required force reduced to minimum on thin cables and automatically increased on thicker cables
- Construction also avoids damaging conductor or insulation while stripping
- Tested for 100,000 operations

Cat No.	UPC No.	Packed	Stripping & Cutting Capacity	Overall Length		Pack Wt.		Shelf Pack
				Inch	mm	lb	kg	
SAS2812	037103489388	Boxed	30-12 AWG (.05-6.0mm ²)	8	202	0.5	2.36	1

Economical Coaxial Wire Stripper

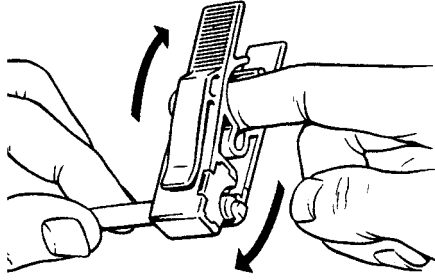

- Spring-like action coaxial wire stripper specially designed to quickly and easily strip RG Series cables for CATV "F" connectors
- Built-in stop (no adjustments needed)
- Replaceable blade cassette lasts 1,000-2,000 strips
- Convenient built-in belt clip

Economical Coaxial Wire Stripper - Pre-adjusted for RG59 & RG6

- Tool specially designed to quickly and easily strip RG 59 and RG 6 cables for CATV "F" connectors
- Built-in stop (no adjustments needed)
- Replaceable blade cassette lasts 1,000-2,000 strips
- Convenient built-in belt clip
- Full operating instructions listed on back of blister card

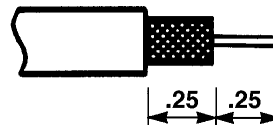

Cat No.	UPC No.	Packed	Description	Pack Wt.		Shelf Pack
				lb	kg	
2CSKCATV	037103045324	Carded	For RG59 and RG6	1/4	6	3
CATVC	037103045331	Boxed	Cassette, spare blades for 2CSKCATV	1/4	6	3

Coaxial Wire Stripper - Full Kits and Pre-adjusted Models

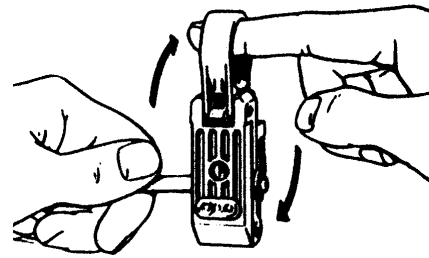

- Fastest accurate coax-stripping system
- Coaxial cable from .10" to .30" (1.87-7.6mm) in thickness (RG 178 up to RG 6) stripped in seconds
- Also removes dielectric, braid and outside insulation
- Xcelite® system available with different color-coded cassettes designed to meet exact stripping specifications
- Cassettes changed in seconds
- Available in full kits for users of many different cable sizes
- Special, pre-adjusted models or cassettes with special strip lengths made upon request

Full Kits - Coaxial Wire Stripper



- Full kit designed for user who strips many different size cables (from .1" to .3"/2.5-7.6mm)
- Contains cassette indicated, all 4 Xcelite® V-Blocks, hex wrench and instruction sheets covering most possible applications
- 3-step models not recommended for cable with hollow dielectric (RG 62) or foam dielectric (use 2-step models instead)
- Cable O.D. range: .10"-.30" (2.5-7.6mm), RG 174 to Belden® 8281 or RG 6

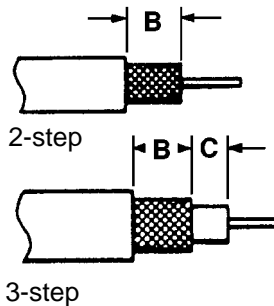

Kit Cat No.	UPC No.	Type	Packed	Cassette Cat No. & Color	Cassette UPC No.	Blade Spacing				Cover Strip Length Specs.				Shelf Pack
						(B)		(C)		(B)		(C)		
						in	mm	in	mm	in	mm	in	mm	
2CSKR	037103489456	2-step	Pouched	2CR red	037103489493	0.24	6.0	-	-	7/32-1/4	5.6-6.3	-	-	1
2CSKB	037103489470	2-step	Pouched	2CB blue	037103489616	0.27	6.8	-	-	1/4-9/32	6.3-7.1	-	-	1
2CSKY	037103489463	2-step	Pouched	2CY yellow	037103489609	0.47	12.0	-	-	7/16-1/2	11.1-12.7	-	-	1
3CSKBR	037103489432	3-step	Pouched	3CBR brown	037103489579	.328	8.3	.109	2.7	5/16-11/32	7.9-8.7	1/16-7/64	1.6-2.8	1
3CSKGN	037103489449	3-step	Pouched	3CGN green	037103489586	.235	6.0	.235	6.0	7/32-1/4	5.6-6.3	13/64-1/4	5.1-6.3	1
3CSKWH	037103489975	3-step	Pouched	3CWH white	037103489986	.266	6.7	.063	1.6	1/4-17/64	6.3-6.7	1/16-3/32	1.6-2.4	1

Note: 3-STEP models are not recommended for cable with hollow dielectrics (RG 62) or foam dielectrics. Use 2-STEP models instead.
 Cable O.D. range: .10"-.30" (2.5-7.6mm) e.g. RG174 to Belden® 8281 or RG6.

Pre-adjusted Models - Coaxial Wire Stripper

- Saves time for novice user who strips primarily just one or a few cables in the same general O.D. range
- Fully adjusted for the cables indicated in chart
- Hex wrench included for adjustment to other size cables
- Simple instructions makes model much less complex than full kits

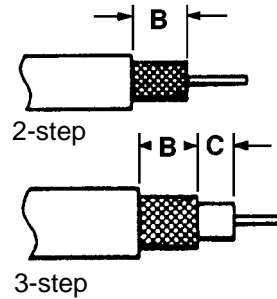

Kit Cat No.	UPC No.	Type	For Cable	Packed	Cassette Cat No. & Color	Cassette UPC No.	Blade Spacing				Cover Strip Length Specs.				Shelf Pack
							(B)		(C)		(B)		(C)		
in	mm	in	mm	in	mm	in	mm	in	mm	in	mm	in	mm		
2CS5962R	037103489524	2-step	58, 59, 6	2Carded	2CR red	037103489493	0.24	6.0	-	-	7/32-1/4	5.6-6.3	-	-	1
2CS5962B	037103489548	2-step	58, 59, 6	2Carded	2CB blue	037103489616	0.27	6.8	-	-	1/4-9/32	6.3-7.1	-	-	1
2CS5962Y	037103489531	2-step	58, 59, 6	2Carded	2CY yellow	037103489609	0.47	12.0	-	-	7/16-1/2	11.1-12.7	-	-	1
3CS5859BR	037103489500	3-step	58, 59	Carded	3CBR brown	037103489579	.328	8.3	.109	2.7	5/16-11/32	7.9-8.7	1/16-7/64	1.58-2.77	1
3CS5859GN	037103489517	3-step	58, 59	Carded	3CGN green	037103489586	.235	6.0	.235	6.0	7/32-1/4	5.6-6.3	13/64-1/4	5.1-6.3	1

Cassettes

- The cassette determines the strip dimension that your stripper will give
- New tool body design allows all cassettes to be used in any 2 step or 3 step full kit or pre-adjusted model
- Cassettes can be interchanged in seconds in the tool body

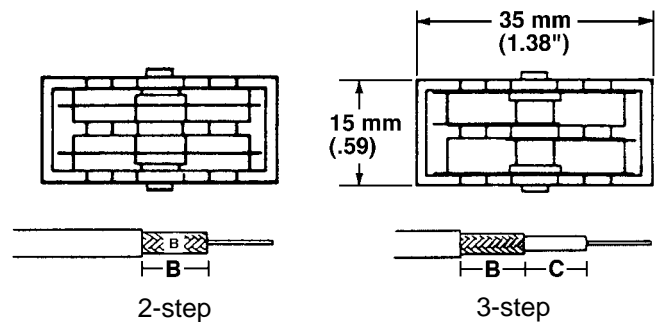

Cassette Cat No. & Color	Cassette UPC No.	Type	Packed	Blade Spacing				Cover Strip Length Specs.				Shelf Pack
				(B)		(C)		(B)		(C)		
in	mm	in	mm	in	mm	in	mm	in	mm	in	mm	
2CR red	037103489493	2-step	Carded	0.24	6.0	-	-	7/32-1/4	5.6-6.3	-	-	1
2CB blue	037103489616	2-step	Carded	0.27	6.8	-	-	1/4-9/32	6.3-7.1	-	-	1
2CO orange	037103489623	2-step	Carded	0.36	9.2	-	-	11/32-13/32	8.7-10.3	-	-	1
3CSKGW	037103489968	3-step	Carded	.235	6.0	.235	6.0	7/32-1/4	5.6-6.3	13/64-1/4	5.1-6.3	1
3SCKW	037103489579	3-step	Carded	.266	6.7	.063	1.6	1/4-17/64	6.3-6.7	1/16-3/32	1.6-2.8	1
3CSKWH	037103489586	3-step	Carded	.328	8.3	.109	2.7	5/16-11/32	7.9-8.7	1/16-7/64	1.6-2.7	1

Belden® is a registered trademark of Belden, Inc.

Replacement V-Blocks

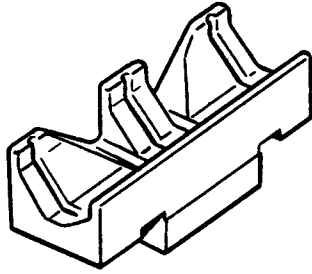

See coaxial wire stripper operating instructions on page 517.

Cat No.	UPC No.	Color	Packed	Cable O.D.		Typical RG Nos.	Shelf Pack
				Inch	mm		
VMD	037103489654	Blue	Boxed	.19-.25	4.8-6.3	58, 59, 62	1
VSUB	037103489661	White	Boxed	.10-.12	2.5-3.0	174, 188, 316	1

NEW IMPROVED FEATURES:

Ergonomical slide design for easier use.

Easier V-block replacement.



All tools have 3 blade adjustment screws so any cassette can be used in any tool



Blade height adjustment gauge. Allows easy adjustment for most common cable sizes. Included in all full kits.



New, more durable blades, provide more than twice the life of the old blades.

Coaxial Wire Stripper Operating Instructions

Note the parts of the stripper in Figure 1.

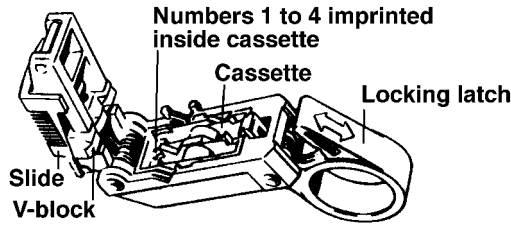

Figure 1

Follow these steps when stripping with the Xcelite® Coaxial Cable Stripper.

A. Adjust slide to position 4 or 5.

B. Open tool by rotating locking latch downward. (Fig. 2)

C. Mark jacket of cable for center conductor length. (If you have a simple wire-cutter, ignore this instruction. You can cut center conductor to length after the strip.)

D. Hold the tool with the handle towards you and insert coax from left into the groove position. Close and latch tool. (Figs. 3 and 4)

E. Push slide forward to appropriate start position (see Fig. 7). Make sure proper V-block is installed.

F. Rotate tool around coax about 5 times (Fig. 5). Push slide forward to next position in sequence. Rotate tool again. Then push slide forward to final position and rotate tool final 5 times.

G. Move slide back one position. Then pull cable out carefully while squeezing tool (Fig. 6).

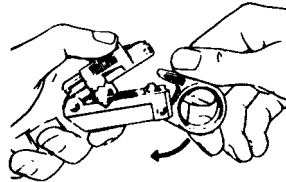

Figure 2

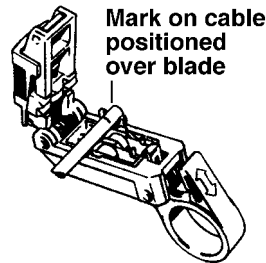

Figure 3

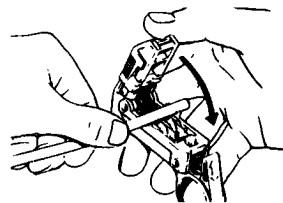

Figure 4

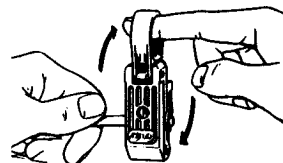

Figure 5

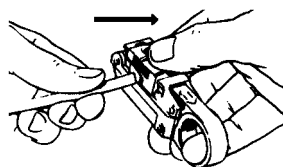

Figure 6

Recommended Settings

Coax	V-block	Slide Progression
RG-58	Blue	3, 2, 1
RG59, 62	Blue	5, 4, 3
RG 174, 188, 316	White	4, 3
RG6	Yellow	5, 4, 3
Belden® 8281	Yellow	5, 4
RG 195, 180	Red	4, 3, 2

Figure 7

V-blocks

Select proper V-block by O.D. of wire (see Fig. 8).

V-block	Cable	Cable	
Part No.	Dia. Range	RG #	Color
VMD	.20"-25" (5-6.4mm)	58, 59	Blue
VSUB	.10-12" (2.5-3mm)	174, 188, 316	White

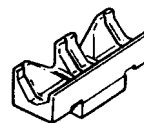

Figure 8

Cassettes

Each cassette contains 4 sets of cutting edges. Cassettes can be reversed each time a blade set wears out. Numbers 1 to 4 are printed inside cassette to determine usage. (see Fig. 1)

To change or reverse cassette, move locking latch in direction of arrow, then push cassette out of tool by inserting wrench through hole in bottom of tool (Fig. 9).

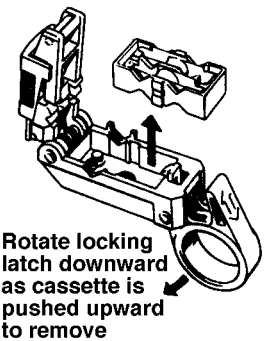

Figure 9

Note: 3-bladed cassettes can only be in positions 1 and 2. Positions 3 and 4 would give reversed strip dimensions!