

APEM

BF Series Paddle Control



HALL EFFECT JOYSTICK AND SWITCH FUNCTIONS

SCULPTED ERGONOMIC DESIGN

5V OPERATION - DUAL REDUNDANT OUTPUTS AS STANDARD

EMC & MAGNETICALLY SHIELDED - ANALOGUE OR PWM OUTPUTS

NEXT GENERATION HALL EFFECT TECHNOLOGY

AVAILABLE WITH COLOUR-CODED INSERTS

SPRUNG AND DETENT LEVER OPTIONS

IP67 SEALED

BF SERIES PADDLE - CONTACTLESS JOYSTICK & SWITCH

PRODUCT OVERVIEW

GENERAL DESCRIPTION

The BF Series Paddle is the very latest generation in high precision contactless controls. It combines the features of a contactless single axis joystick and a switch in one control.

Long trouble-free life is assured with the latest hall effect technology, providing a range of analogue, switched or custom PWM output options. The all-new design with its innovative mechanism and ergonomic styling is specifically designed for robustness, strength and performance.

As well as all of the features you would expect from the very latest in joystick technology, the innovative design of the BF Series Paddle introduces a number of new functions and product features:

- **EFFECTIVELY ZERO BELOW PANEL DEPTH**
- **ERGONOMIC DESIGN COMBINES CONTACTLESS JOYSTICK AND SWITCH FUNCTIONS IN ONE CONTROL**
- **TWO HALL EFFECT SWITCHES WITH SELECTABLE SWITCHING POINTS**
- **TWO INDEPENDENT ANALOGUE OUTPUTS WITH A RANGE OF GAIN OPTIONS**
- **DUAL (REDUNDANT) OUTPUTS AS STANDARD** - With either the same or inverted polarity.
- **PWM OUTPUT OPTIONS**
- **END STACKABLE MOUNTING**
- **AVAILABLE WITH A RANGE OF COLOURED HANDLE INSERTS**
- **INNOVATIVE HARD-WEARING MECHANISM**
- **LEVER CAN BE SPRUNG TO CENTRE, WITH OR WITHOUT DETENTS, OR CAN BE FRICTIONED WITH DETENTS**
- **DETENT LEVER OPTION PROVIDES TACTILE FEEDBACK AND ALLOWS POSITIVE POSITIONING**
- **HIDDEN FIXINGS**
- **HALL EFFECT SENSING** - Latest technology, a reduced part count and an ease of integration.
- **HIGH EMC IMMUNITY** - Integral shielding, as standard.
- **MAGNETICALLY SCREENED**
- **INDUSTRY STANDARD CONNECTOR**

BF SERIES PADDLE - CONTACTLESS JOYSTICK & SWITCH CONFIGURATIONS & OUTPUTS

OUTPUT OPTIONS

The BF Series Paddle is configured as two “electrical” controls in one mechanical package. The Paddle operates from 5V and provides two proportional outputs. The second output is accurate to the first within +/-2% of the power supply. The power supply for the secondary output is also completely independent. Customers may choose their preference of voltage outputs (gains).

The secondary output can be of the same or inverse polarity to the primary wiper. For example, with a secondary inverse output, the first and second outputs can be summed and compared to zero to verify that the joystick is operating correctly. Paddles having two identical outputs of the same polarity may be used to drive two identical dual redundant circuits.

There are also two Hall Effect switches that trigger at pre-determined lever positions.

The BF Series Paddle may be specified with a variety of PWM output options. For more details on available PWM options please refer to Apem.

ADDITIONAL OUTPUT INFORMATION

SELECTABLE SWITCHING POINTS

The Paddle incorporates two Hall Effect switches. The angle of the lever at the switch trigger point can be selected when ordering.

If no switches are specified then the output on pins 2 and 7 will be unused.

The outputs are configured as ‘open drain’ type with a 1K5 pull up resistor to 5V.

GAIN OPTIONS

The voltage output on the wiper, at full scale deflection is determined by the gain. The gain is expressed as a percentage of the voltage supplied. Therefore (assuming a 5V supply) a Paddle specified with +/- 25% gain would yield 1.25V at South, 2.5V at centre and 3.75V at North. A range of gain options are available as standard. All controls are supplied pre-set and no further calibration is needed throughout the lifetime of operation.

OUTPUT IMPEDANCE

The voltage outputs at centre and at each end of travel are specified across an infinite load, with no current flowing. The output impedance specified in the electrical specification should be taken into account when designing a system. Load resistance of less than 10K Ohms is not recommended.



BF SERIES PADDLE - CONTACTLESS JOYSTICK & SWITCH

MECHANICAL & CONNECTION INFORMATION

MECHANISM

The brand new mechanism design has been developed for strength and long life whilst retaining a superb feel.

SPRUNG TO CENTRE

The lever springs back to the centre position when released.

DETENT POSITIONS

The lever 'clicks' into a number of preset positions. The internal switches can be configured to trigger at 2 of these points.

DETENT POSITIONS WITH SPRUNG TO CENTRE

The lever 'clicks' into a number of preset positions and springs back to its centre position when released.

CONNECTIONS

The Paddle is fitted, as standard, with an industry standard 2.54mm pitch 8 way connector.

CONNECTIONS

Paddles are supplied with an eight way connector as standard.

- PIN 1:** 5V
- PIN 2:** Switch 1(+)
- PIN 3:** 0V
- PIN 4:** Analogue / PWM output 1
- PIN 5:** Analogue / PWM output 2
- PIN 6:** 0V
- PIN 7:** Switch 2 (-)
- PIN 8:** 5V

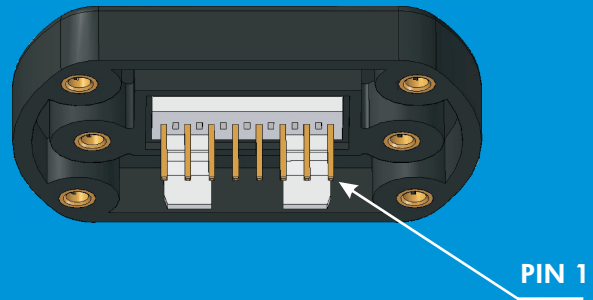

BF SERIES OUTPUT CHARACTERISTICS

40% GAIN DUAL INVERSE OUTPUTS

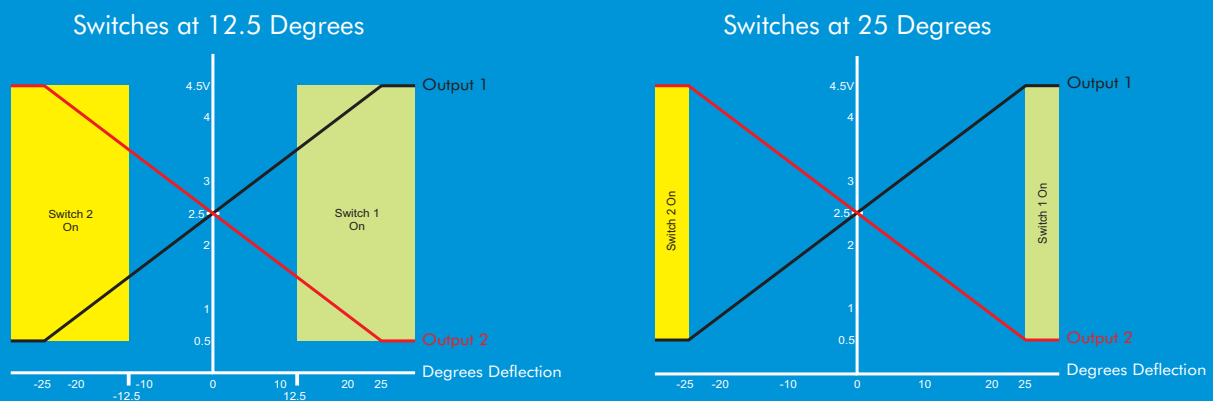

Equivalent circuit for the switch output

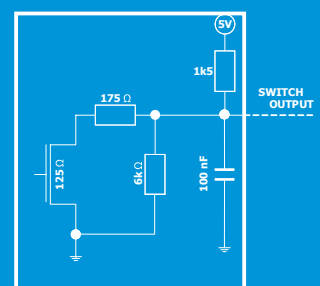

The two switch outputs are configured as 'Open Drain' with a 1K5 pull-up to the 5V. Both outputs are 'Active Low' and can sink up to 10mA each. Voltage output (open circuit) is 0.8V low and 4.0V High.

BF SERIES PADDLE - CONTACTLESS JOYSTICK & SWITCH

PRODUCT SPECIFICATION

TECHNICAL SPECIFICATION

All parameters shown are based on a standard configuration and are provided for guidance only. Please refer to Apem for assistance on how to achieve the best performance from your chosen configuration.

ELECTRICAL

Gain (Output Voltage Span): +/-10% x V to +/-50% x V

Output at Centre: V/2 +/- (5% x Gain)

Power Supply: 5V +/-0.5V Transient free

Switch Outputs: Open Drain, pulled high within control via 1K5 to 5V, and smoothed to 0V with 100nF

Sensor Type: Hall Effect

Current Consumption: <20mA

Loads: Minimum 10K, preferred 100K+

ENVIRONMENTAL

Storage : -40C to +70C

Operating Temperature: -25C to +70C

Seal Above Panel: IP67 (Gasket fitted as standard)

EMC Emissions: Complies with EN 61000-6-3:2001 CISPR 22:2005 Class B 30MHz - 11GHz

Life Cycles: 5,000,000 cycles sprung version only. Detents rated to 2,000,000 cycles.

ESD: Complies with EN61000-4-2 (extended) +/-8KV (20 contacts) & +/-15KV (20 air discharges)

EMC Immunity: 100V/m, 80MHz-2.7GHz, 1KHz 80% sine wave modulation, EN 61000-4-3 (extended)

Vibration: 100Hz - 200Hz @ 0.13g²/Hz, total 3.6gRMS (1 Hour in each of the three mutually perpendicular axes)



MECHANICAL

Materials Employed :

Polyetherimide
Polycarbonate
Stainless Steel

Weight: 50g

Mechanical Operating Angle: +/- 25 Degrees

Max Load to Mechanism:

Vertical: IK08 (BSEN62262:2002)
Horizontal: 75 N



BF SERIES PADDLE - CONTACTLESS JOYSTICK & SWITCH

PRODUCT OPTIONS

STANDARD OPTION SELECTION

To specify your BF Series Paddle, simply choose one option from each column. An example is shown below.

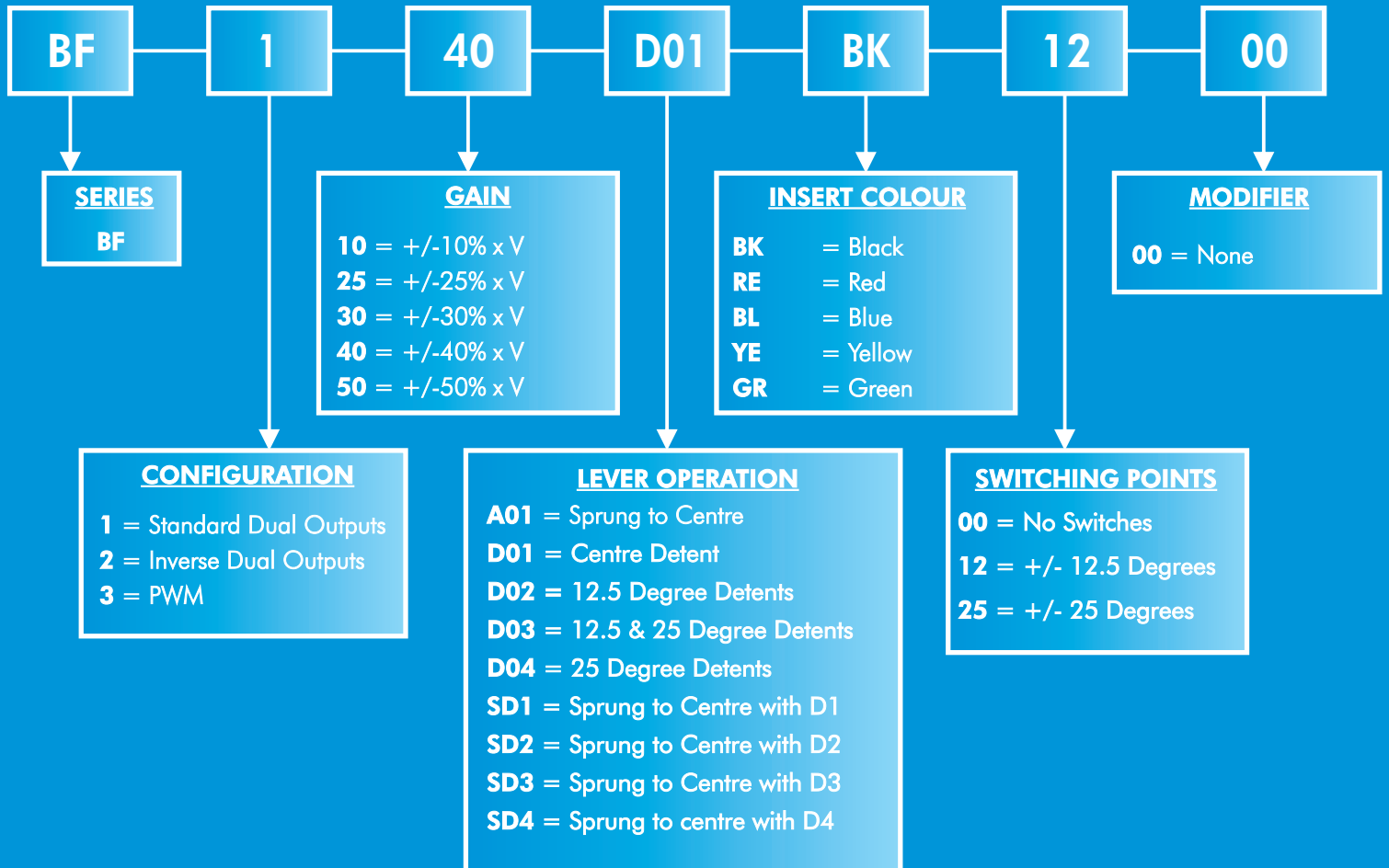

LEVER OPERATION

DETENT OPTIONS

D01 = CENTRE DETENT

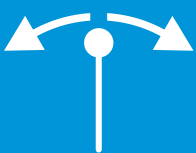

D02 = +/-12.5 DEGREES

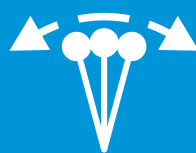

D03 = +/- 12.5 & 25 DEGREES

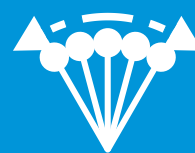

D04 = +/- 25



SPRUNG TO CENTRE WITH DETENT OPTIONS

SD1 = CENTRE DETENT

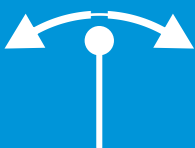

SD2 = +/-12.5 DEGREES

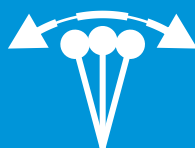

SD3 = +/- 12.5 & 25 DEGREES

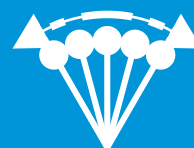

SD4 = +/- 25 DEGREES



BF SERIES PADDLE - CONTACTLESS JOYSTICK & SWITCH

USEFUL DIMENSIONS

GENERAL DIMENSIONS

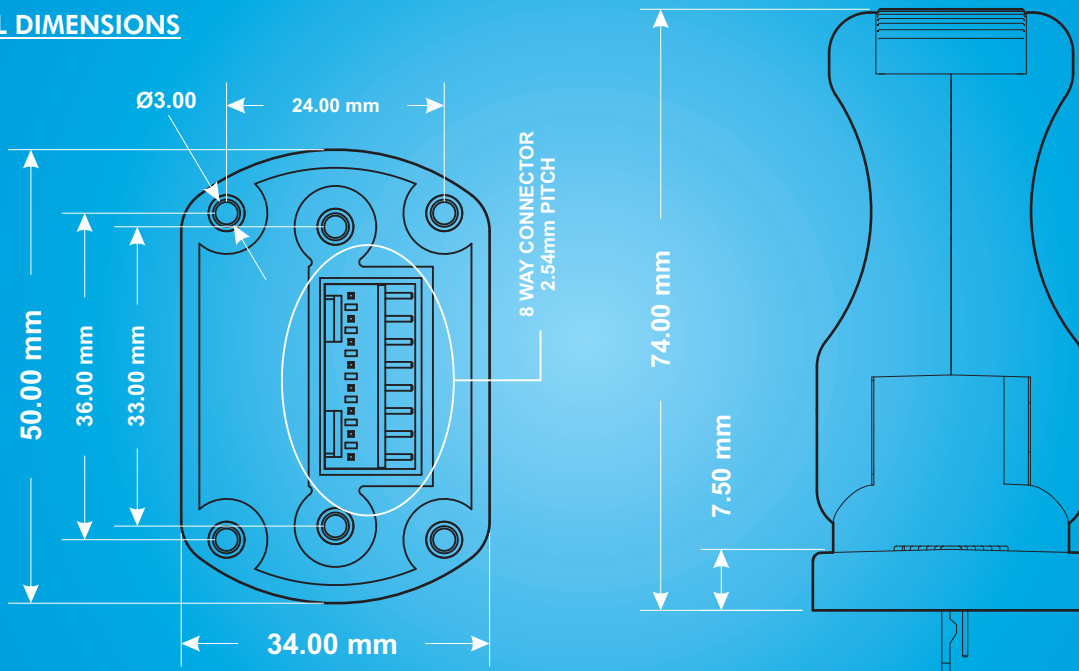

DROP IN MOUNTING - PANEL CUT-OUT & MOUNTING INSTALLATION

The Paddle may be mounted with two different hole patterns:

- Two screws - in line on the Y axis (shown as yellow screws)
- Four screws - one in each corner (shown as silver screws)

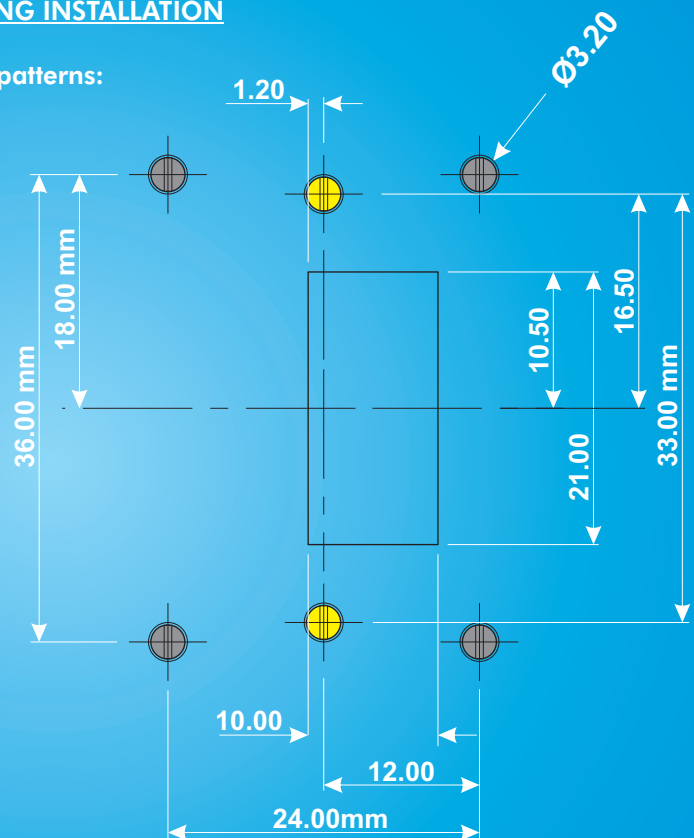

The Paddle is fitted with M3 bushes in all six positions, as standard.
Fasteners are not supplied as standard. The appropriate length of fastener is dependent on panel thickness.

All dimensions in mm

BF SERIES PADDLE - CONTACTLESS JOYSTICK & SWITCH

APPLICATION DETAILS

LATEST TECHNOLOGY

The design of the new BF Series Paddle, introduces many new features and manufacturing techniques.

POWER SUPPLY

The BF Series is designed to be powered by a regulated 5V +/- 0.5V power supply. The outputs are ratiometric, making a stable, noise free, power supply essential. The power supply to the joystick should be carefully regulated to be within tolerance. Should the power supply change outside of the specified tolerances, permanent damage may occur.

MAGNETIC IMMUNITY AND SYSTEM DESIGN

The BF Series incorporates internal magnetic screening to minimise the effect of external magnetic fields. Mounting or operating the Paddle close to strong magnetic fields is not recommended. System designers should follow best practice when incorporating the BF Series Paddle into their products. Care should be taken to decouple the power supply properly and to employ adequate EMC shielding.

MOUNTING

When mounting the Paddle, care should be taken to site it in a position that does not make it vulnerable to damage when in use. If the Paddle is intended for use in a handheld enclosure then care must be taken to protect the Paddle from damage caused by dropping. Basic precautions such as mounting it at the lightest end of the enclosure so it doesn't hit the ground first or by protecting it with a guard should always be implemented for long term reliability. The body of the Paddle, on the underside of the panel, must not be subject to water spray, excessive humidity or dust.

CALIBRATION

The BF Series is calibrated in the factory therefore no subsequent adjustments are required.

CONTACT US

For more information
on Apem or other
Apem products,
please visit:

www.apem.com

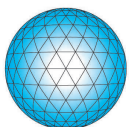

APEM

www.apem.com

Note: The company reserves the right to change specifications without notice.