

## 1 Features

- Designed for 2.4 GHz applications [Bluetooth™, WiFi™ (802.11b/g), Zigbee™, WiMedia™ etc.]
- Intended for SMD mounting
- Supplied in tape on reel

## 2 Description

The Mica antenna is intended for use with all 2.4 GHz applications. The antenna requires a groundplane, i.e. your device acts as an active part of the antenna and thus demand careful consideration concerning its placement.

## 3 Application

- Mobile phones
- PDAs
- Headsets
- Laptops
- Medical equipment
- Automotive



## Contents

|  |    |
|--|----|
| 1 Features                                   | 1  |
| 2 Description                                | 1  |
| 3 Application                                | 1  |
| 4 Model name                                 | 3  |
| 5 General data                               | 3  |
| 6 Electrical characteristics                 | 3  |
| 7 Electrical performance                     | 3  |
| 7-2 3D-Radiation                             | 4  |
| 7-3 Radiation patterns                       | 4  |
| 8 Antenna Dimensions                         | 5  |
| 9 Antenna Footprint                          | 5  |
| 10 Electrical interface                      | 6  |
| 10-1 Transmission line and matching          | 6  |
| 10-2 Test board dimensions                   | 6  |
| 10-3 Test board matching                     | 7  |
| 11 Soldering                                 | 7  |
| 11-1 Recommended soldering conditions        | 7  |
| 11-2 Leadfree soldering                      | 7  |
| 12 Reliability                               | 8  |
| 12-1 Temperature and Humidity                | 8  |
| 12-2 Mechanical                              | 8  |
| 12-3 Miscellaneous                           | 8  |
| 12-4 Judgement standard                      | 9  |
| 13 Hazardous Material Regulation Conformance | 9  |
| 14 Application example                       | 9  |
| 15 Packaging                                 | 10 |
| 15-1 Shelf storage recommendation            | 10 |
| 15-2 Tape characteristics                    | 10 |
| 15-3 Reel dimension                          | 11 |
| 15-4 Box dimension                           | 11 |
| 15-5 Bag properties                          | 11 |
| 15-6 Reel label information                  | 11 |

## 4 Model name

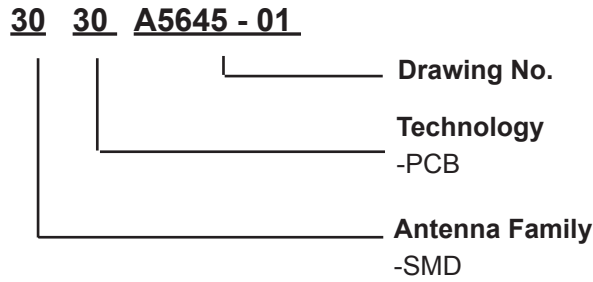

## 5 General data

|                       |                  |
|-----------------------|------------------|
| Product Name          | Mica 2.4 GHz     |
| Article No.           | 3030A5645-01     |
| Frequency             | 2.4-2.5 GHz      |
| Polarization          | Linear           |
| Operating temperature | -40 to + 85 degC |
| Impedance             | 50 Ohm           |
| Weight                | 0.4 gram         |
| Antenna type          | SMD              |

## 6 Electrical characteristics

|            | Characteristics |         |         | Conditions*   |
|------------|-----------------|---------|---------|---|
|            | Min             | Typ     | Max     |   |
| Peak Gain  | 0.8 dBi         | 1.2 dBi | 1.9 dBi | Frequency 2.4-2.5 GHz, Measured in 3D chamber ( near field) |
| Efficiency | 70%             | 75%     | 79%     |   |
| VSWR       | 1.0:1           | 1.5:1   | 1.9:1   | Frequency 2.4-2.5 GHz, Measured in Network Analyzer         |

\*Note all data provided in this table are based on the gigaNOVA™ reference board

## 7 Electrical performance

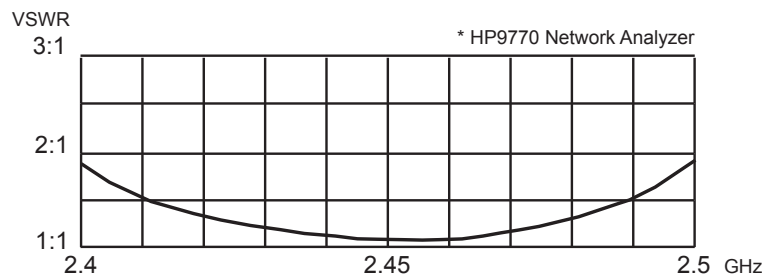

7-2 3D-Radiation

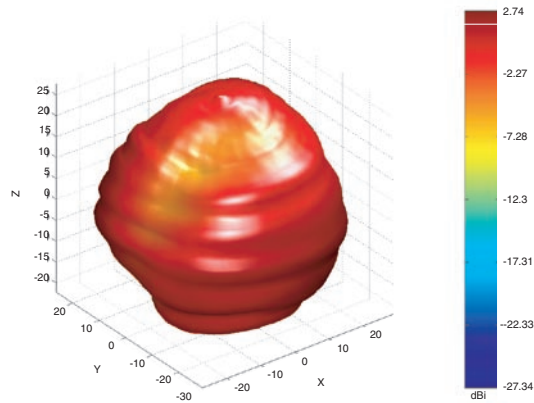

7-3 Radiation patterns

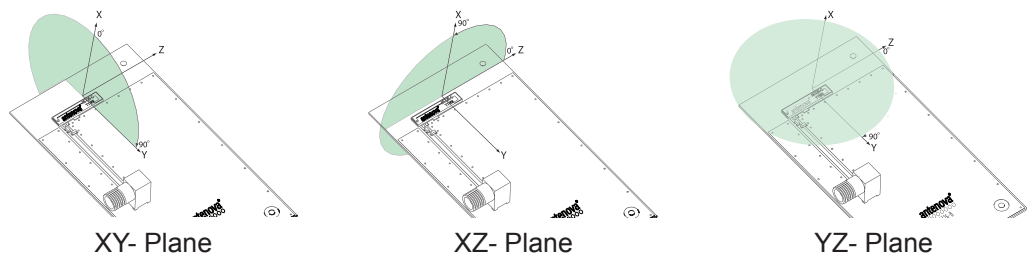

Total Polarization

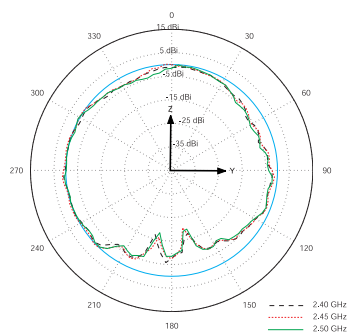
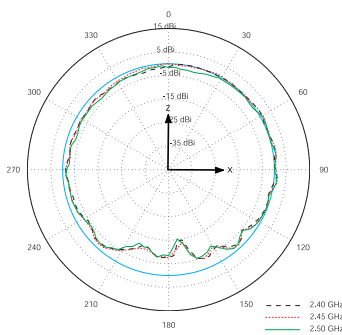
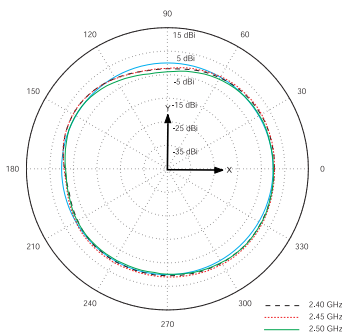

Vertical Polarization

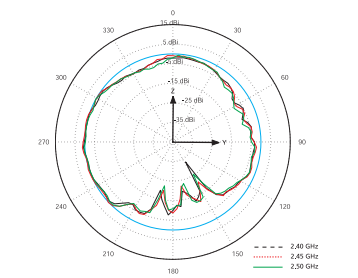
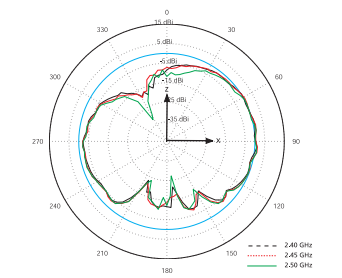
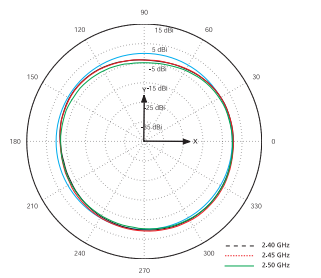

Horizontal Polarization

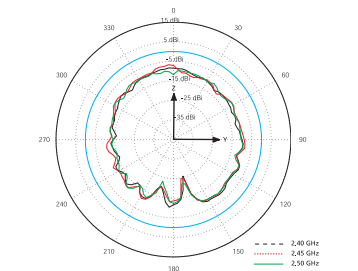
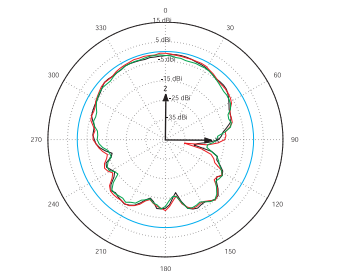
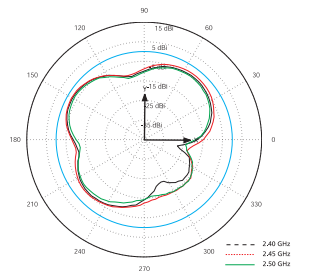

### 8 Antenna Dimensions

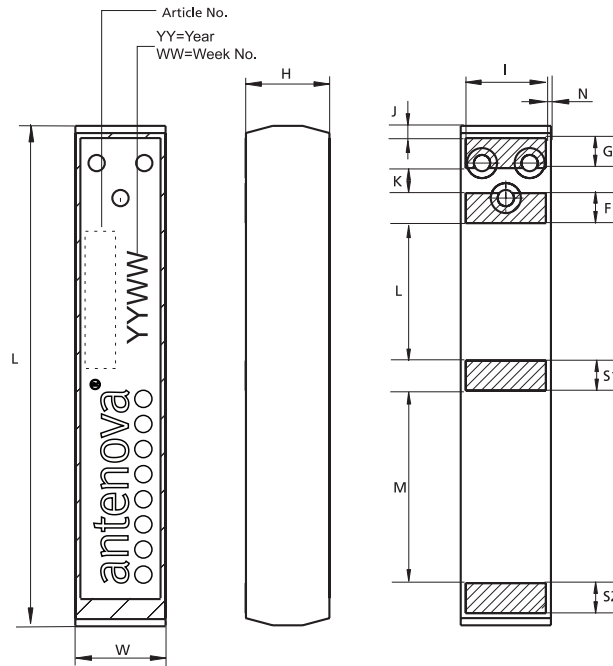

| L         | W        | H       | G       | F       | S1, S2  | I       | J         | K       | L       | M       | N       |
|-----------|----------|---------|---------|---------|---------|---------|-----------|---------|---------|---------|---------|
| Length    | Width    | Height  | Ground  | Feed    | Solder  | Feed    | Feed      |         |         |         |         |
| 20.5 ±0.2 | 3.6 ±0.1 | 3.3±0.2 | 1.2±0.1 | 1.2±0.1 | 1.2±0.1 | 3.2±0.1 | 0.55±0.25 | 1.0±0.1 | 5.5±0.1 | 7.7±0.1 | 0.2±0.1 |

Dimensions in millimeters.

### 9 Antenna Foot print

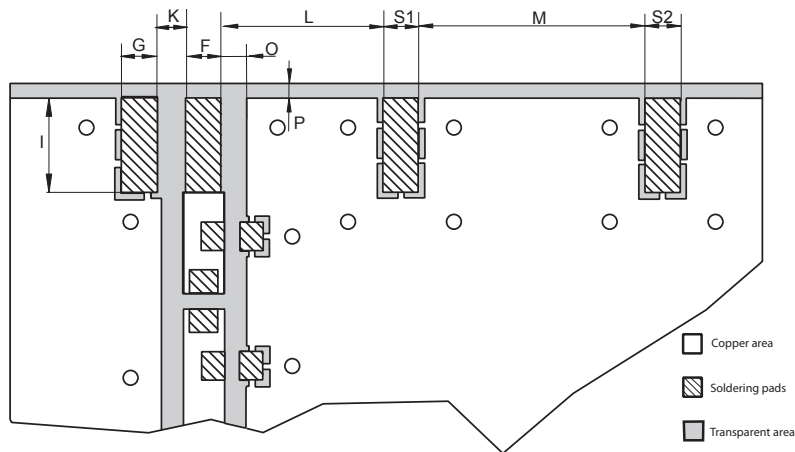

| G       | F       | S1      | S2      | I       | K       | L       | M       | O       | P       |
|---------|---------|---------|---------|---------|---------|---------|---------|---------|---------|
| Ground  | Feed    | Solder  | Solder  |         |         |         |         |         |         |
| 1.2±0.1 | 1.2±0.1 | 1.2±0.1 | 1.2±0.1 | 3.2±0.1 | 1.0±0.1 | 5.5±0.1 | 7.7±0.1 | 0.5±0.1 | 0.5±0.1 |

Dimensions in millimeters.

## 10 Electrical interface

### 10-1 Transmission line and matching

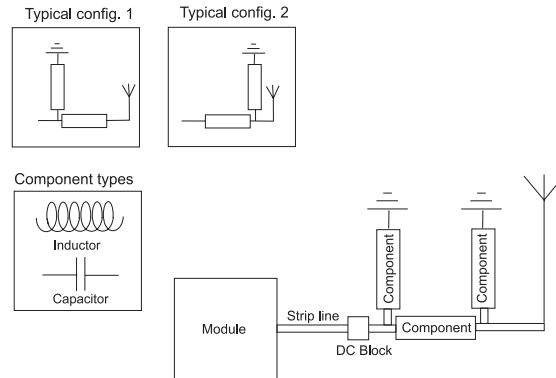

The matching network has to be individually designed using one, two or three components.

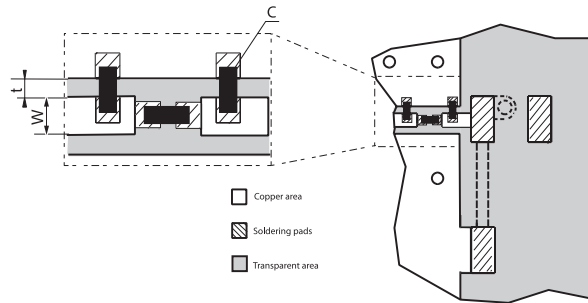

$t, w$  = Unique dimensioning according to your PCB \*

$C$  = Inductor and capacitor values according to your specific device\*

\* Antenna provides this service upon request

### 10-2 Test board dimensions

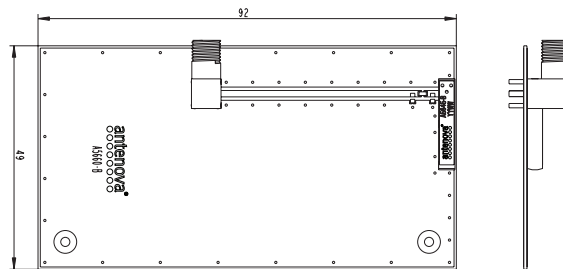

The testboard is designed for evaluation purposes for Mica 2.4 GHz SMD antenna. The board has the same size as a typical PCMCIA card and is fitted with an SMA connector.

### 10-3 Test board matching

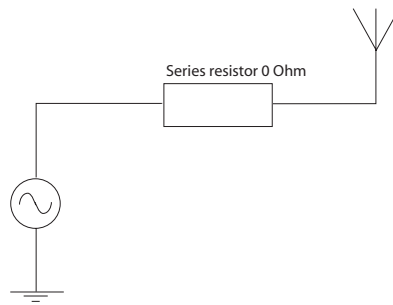

The testboard is matched with above specified component.

**Note! The component value(s) will vary depending on size of PCB, surrounding components etc.**

## 11 Soldering

### 11-1 Recommended soldering conditions

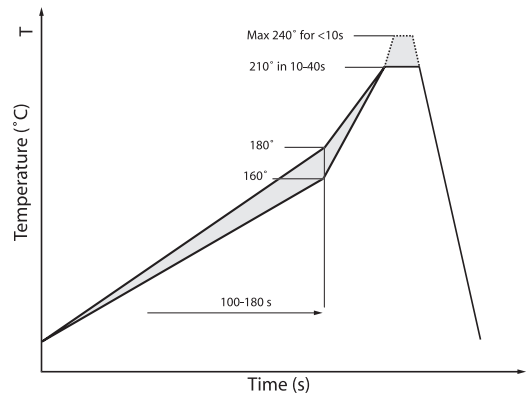

### 11-2 Leadfree soldering

The antenna has been tested and approved for leadfree soldering. The reflow curve and solder paste used is listed below.

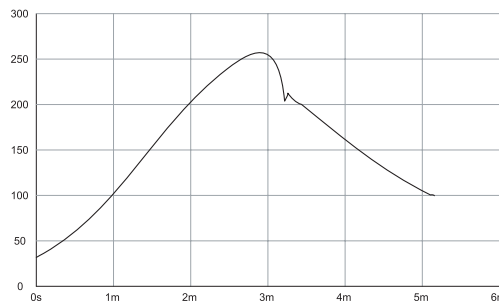

Solder paste: KOKI S3X58-M405

## 12 Reliability

### 12-1 Temperature and Humidity

| Item                             | Standard   | Low               | High      | Duration           |
|----------------------------------|--|-------------------|-----------|--------------------|
| Operating temperature            | EN/IEC 60068-2-2,<br>Test Bd: Dry heat               | -30 degC          | +90 degC  | -                  |
| Temperature cycling              | EN/IEC 60068-2-14,<br>Test Na: Change of temperature | -40 degC          | +90 degC  | 500 cycles /10 min |
| Storage life<br>Humidity         | EN/IEC 60068-2-1,<br>Test Ca: Damp heat              | +60 degC / 90% RH |           | 500 h              |
| Storage life<br>Low temperature  | EN/IEC 60068-2-1,<br>Test Ad: Cold                   | -55 degC          | -         | 500 h              |
| Storage life<br>High temperature | EN/IEC 60068-2-2,<br>Test Bb: Dry heat               | -                 | +125 degC | 500 h              |

### 12-2 Mechanical

| Item      | Standard                                  | Low   | High | Duration                                 |
|-----------|---|---|------|--|
| Bending   | IEC 60068-2-21,<br>Test Ue1: Bending      | Bending 1 mm at a rate of 1 mm/s<br>with support at end of PCB<br>1mm depth on reference board                          |      |  |
| Shear     | IEC 60068-2-21,<br>Test Ue3: Shear        | Force of 5 N applied to the side of the<br>antenna.   |      |  |
| Drop test |   | Dummy weight: 150g<br>Height: 170cm   |      | One drop at each side,<br>total drops: 6 |
| Vibration | EN/IEC 60068-2-6,<br>Test Fc (sinusoidal) | Acceleration spectral density:10-1000Hz<br>Acceleration: 20m/s <sup>2</sup><br>Number of axes: 3 mutually perpendicular |      | 5 cycles per axis                        |

### 12-3 Miscellaneous

| Item          | Standard                      | Low   | High | Duration |
|---------------|-------------------------------|---|------|----------|
| Solderability | EN/IEC 60068-2-58,<br>Test Td | Visual inspection of soldering pads.<br>Estimation of how many % of the<br>pads that are well tin plated. |      |          |



### 12-4 Judgement standard

The judgement of the above tests should be made as follows:

1. Visual inspection - Normal appearance with no obvious cracking, peeling-off.
2. Electrical inspection - The DUT satisfies the VSWR specification throughout the 2.4-2.5 GHz band.

### 13 Hazardous Material Regulation Conformance

|   |  |
|---|--|
| Cadmium and cadmium compound.           | Lead and lead compound                   |
| Organic brominated compound (PBB, PBDE) | Mercury and mercury compound             |
| Polychlorinated biphenyl (PCB)          | Sexivalent chrome compound               |
| Polychlorinated naphthalene (PCN)       | Chlorinated paraffin (CP)                |
| Organic tin compound                    | Mirex                                    |
| Asbestos                                | Formaldehyde                             |
| Azo compound                            | Tetra-bromo-bisphenol-A-bis (TBBP-A-bis) |

### 14 Application example

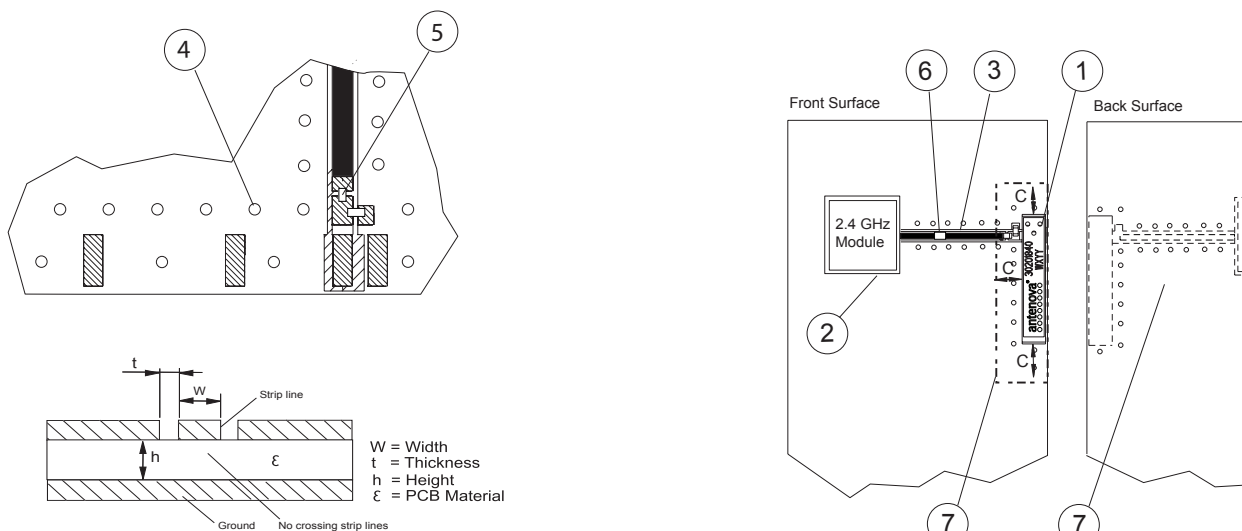

#### General

The antenna is of a quarter wave type and is dependent on the groundplane area to complete the antenna function. The antenna performance is also dependent on the size of the groundplane.

- 1. Placement of the antenna**  
The antenna shall be placed on a groundplane area, preferably at the edge of the PCB oriented as above.
- 2. Placement of 2.4 GHz module**  
To avoid losses in the strip line, the module shall be placed as close to the antenna as possible.
- 3. Strip line**  
The strip line must be dimensioned according to your specific PCB. ( see fig 1). No crossing strip lines are allowed between the strip line and its ground plane.
- 4. Via connections**  
To avoid spurious effects, via connections must be made to analogue ground.

**5. Component matching**

Component values are depending on antenna placement, PCB dimensions and location of other components.

**6. DC Block**

Might be needed depending on RF Module configuration.

**7. Clearance**

Front surface: Minimum clearance to other components, C = 2-5 mm.  
Back surface: Components allowed.

**8. Casing material**

No metal casing or plastics using metal flakes shall be used, avoid also metallic based paint or laquer.

**Note ! Incorrect implementation of the antenna will affect the performance.  
Contact Antenva for implementation services.**

## 15 Packaging

### 15-1 Shelf storage recommendation

|                      |   |
|----------------------|---|
| <b>Temperature</b>   | -10 to +40 degree C                         |
| <b>Humidity</b>      | Less than 75% RH                            |
| <b>Shelf Life</b>    | 18 Months                                   |
| <b>Storage place</b> | Away from corrosive gas and direct sunlight |

### 15-2 Tape characteristics

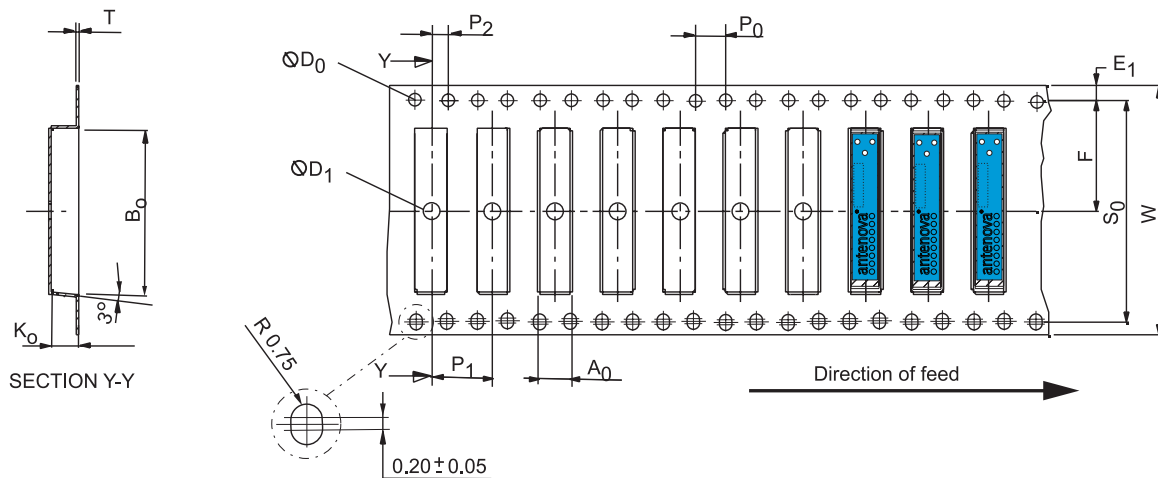

| W      | S <sub>0</sub> | F        | E <sub>1</sub> | P <sub>0</sub> | P <sub>1</sub> | P <sub>2</sub> | A <sub>0</sub> | B <sub>0</sub> | K <sub>0</sub> | T        | D <sub>0</sub> | D <sub>1</sub> |
|--------|----------------|----------|----------------|----------------|----------------|----------------|----------------|----------------|----------------|----------|----------------|----------------|
| 32±0.3 | 28.4±0.3       | 14.2±0.1 | 1.75±0.1       | 4.0±0.1        | 8.0±0.1        | 2.0±0.1        | 4.0±0.1        | 21±0.1         | 3.7±0.1        | 0.3±0.05 | 1.5±0.1        | Min 2.0        |

Dimensions in millimeters

| Quantity        | Leading space            | Trailing space           |
|-----------------|--------------------------|--------------------------|
| 2000 Pcs / reel | 50 blank antenna holders | 37 blank antenna holders |

**15-3 Reel dimension**

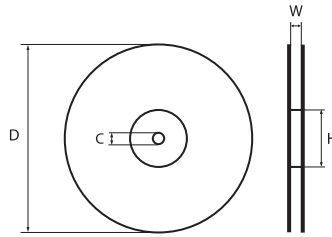

|                |                        |
|----------------|------------------------|
| Material:      | Conductive Polystyrene |
| Width [mm]     | W: 32                  |
| Reel dia [mm]  | D: 330(13")            |
| Hub dia [mm]   | H: 100(4")             |
| Shaft dia [mm] | C: 13                  |

**15-4 Box dimension**

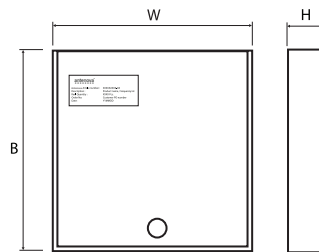

|                |           |
|----------------|-----------|
| Material:      | Cardboard |
| Width [mm]     | W: 345    |
| Breadth [mm]   | B: 345    |
| Thickness [mm] | H: 45     |

**15-5 Bag properties**

Antistatic Aluminium Moisture Barrier Bag

Thickness [mil] T: 3.2

**15-6 Reel label information**

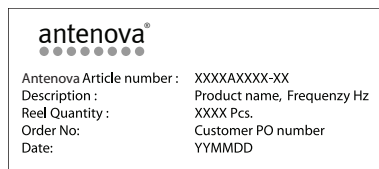



[www.antenova.com](http://www.antenova.com)

### Corporate Headquarters

**Antenova Ltd.**

Far Field House  
Albert Road  
Stow-cum-Quy  
Cambridge  
CB9 5AR

**Tel:** +44 (0) 1223 810600  
**Fax:** +44 (0) 1223 810650  
**Email:** [info@antenova.com](mailto:info@antenova.com)

### Asia Headquarters

**Antenova Asia Ltd.**

3F, No 10, Alley 6, Lane 45  
Poa Shing Road  
Hsin Tien City  
Taipe County  
ROC 23145

**Tel:** +886 (0) 2 2917 6536  
**Fax:** +886 (0) 2 2910 6546  
**Email:** [info@antenova.com](mailto:info@antenova.com)

### Sales Offices

#### Europe

**Charlotta Olander**

UK/EU Sales Manager

**Tel:** +46 702 913731  
**Email:** [Lotta.Olander@antenova.com](mailto:Lotta.Olander@antenova.com)

#### America

**David Nuti**

NA Sales Manager

**Tel:** +1 214 668 0357  
**Email:** [David.Nuti@antenova.com](mailto:David.Nuti@antenova.com)

#### Asia

**CL Lim**

VP Sales Asia

**Tel:** +886 (0) 931 201 318  
**Email:** [CL.Lim@antenova.com](mailto:CL.Lim@antenova.com)



Certificate No: 4598/04

Integrated Antenna Solutions