

# Mixtus Dual-band Wi-Fi SMD Antenna

Part No. A10194

Product Specification

## 1 Features

- Designed for 2.4 – 2.5 GHz and 4.9 – 5.0 GHz applications: 802.11a/b/g/j/n, Wi-Fi<sup>®</sup>
- Easy to integrate
- High efficiency
- Light weight
- Intended for SMD mounting
- Supplied in tape on reel

## 2 Description

Mixtus is intended for use with all dual-band Wi-Fi applications, including 802.11n MIMO. The antenna requires a ground plane, i.e. your device acts as an active part of the antenna and thus demands careful consideration concerning its placement.

## 3 Applications

- Mobile phones
- PDAs
- Portable Media Players (PMPs)
- Headsets
- PC-Cards
- Game Consoles
- Access Points
- Set-top-box
- Networked Digital TVs

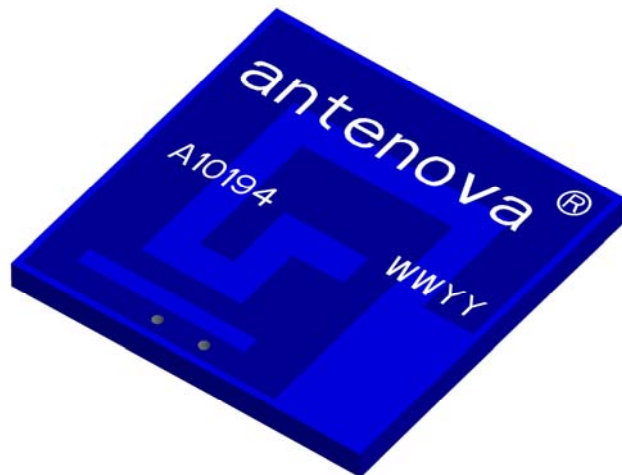

## 4 Part No.

Mixtus: A10194



## 5 General data

Product name	Mixtus Wi-Fi
Part No.	A10194
Frequency	2.4 – 2.5 GHz and 4.9 – 5.9 GHz
Polarization	Linear
Operating temperature	-40 °C to +85 °C
Impedance with matching	50 Ω
Weight	0.2 g
Antenna type	SMD
Dimensions	10 x 10 x 0.9 [mm]

## 6 Electrical characteristics

	Typical performance	Conditions
Peak gain	1.8 dBi	<b>Data given for the 2.4 – 2.5 GHz frequency range</b> All data measured on Antenna's reference board part number AN-1-0668-4
Average gain	-0.5 dBi	
Average efficiency	>75%	
Maximum Return Loss	-15 dB	
Maximum VSWR	1.4:1	
Peak gain	4.1 dBi	<b>Data given for the 4.9 – 5.9 GHz frequency range</b> All data measured on Antenna's reference board part number AN-1-0668-4
Average gain	-2.3 dBi	
Average efficiency	>60%	
Maximum Return Loss	-11 dB	
Maximum VSWR	1.8:1	

# 7 Electrical performance

## 7-1 Return Loss

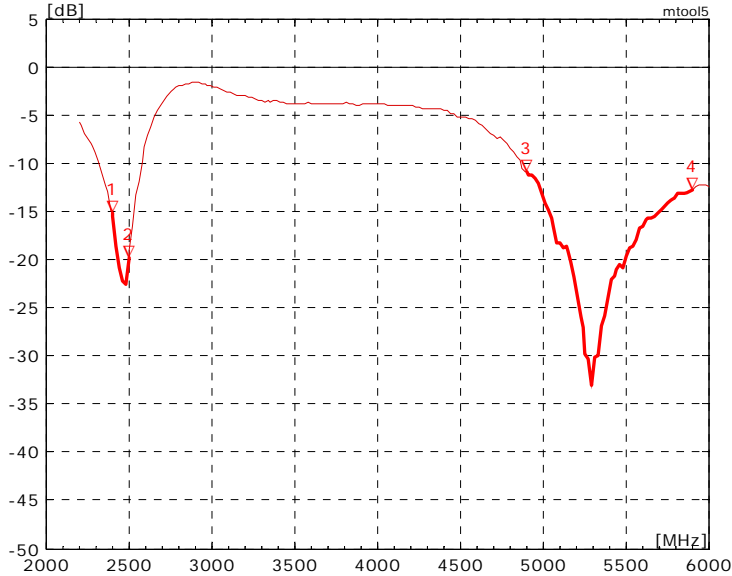

## 7-2 VSWR

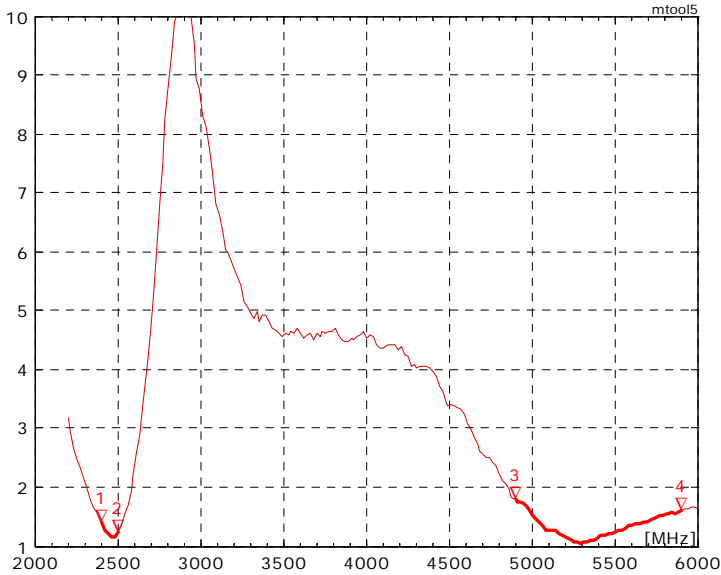

7-3 Antenna patterns

7.3.1. 2400 MHz – 2500 MHz

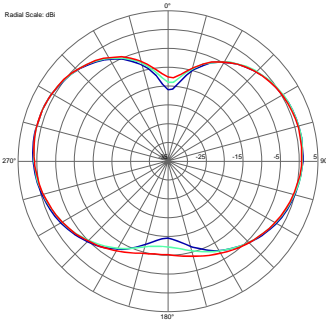
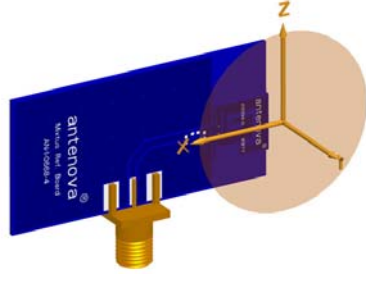
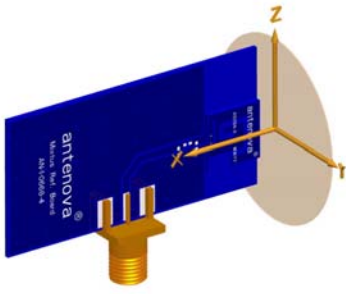
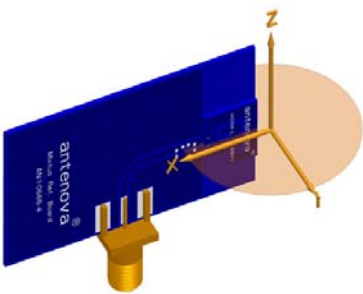
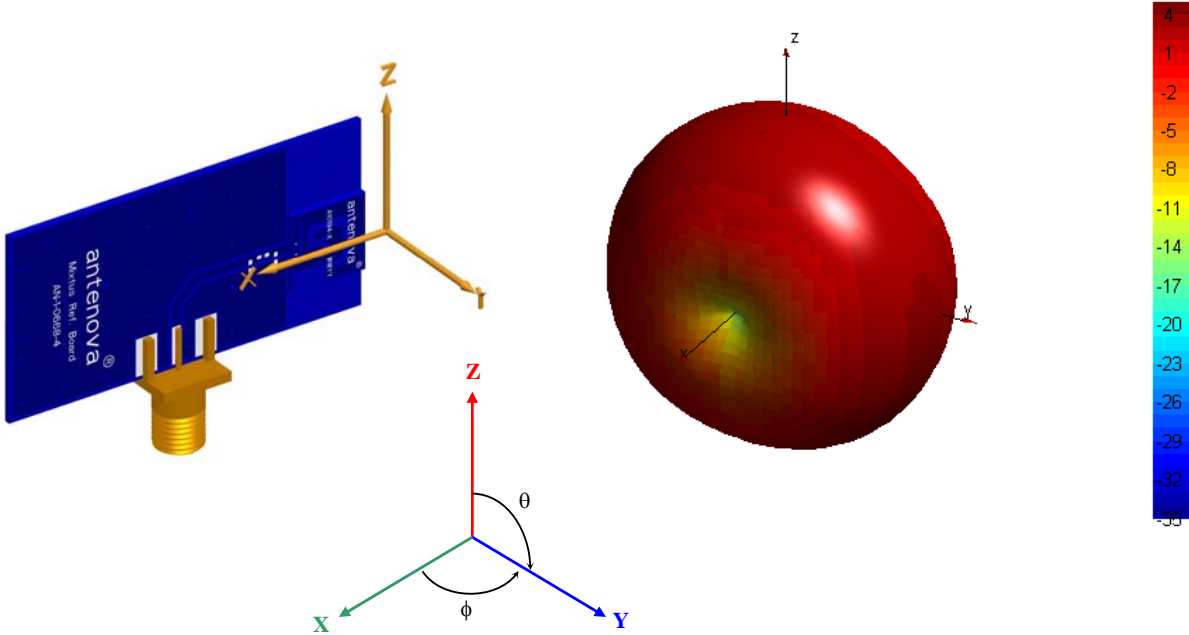

XY plane

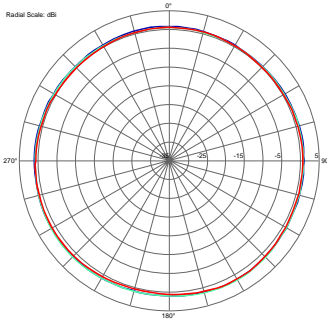

YZ plane

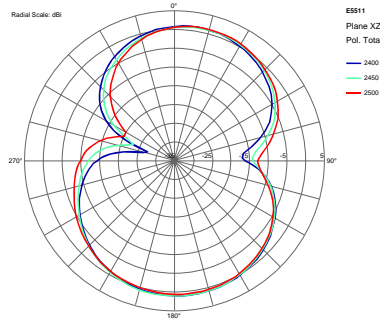

XZ plane

Patterns show combined polarisations  
 measured on reference board AN-1-0668-4

7.3.2. 4900 MHz – 5900 MHz

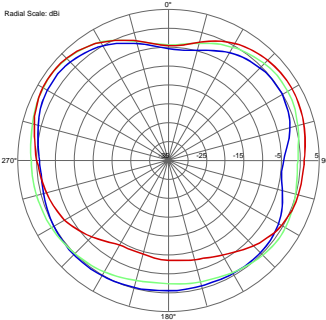
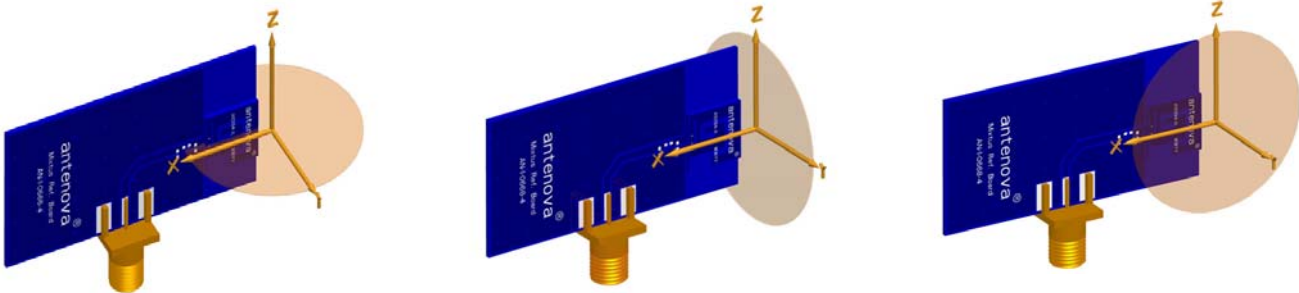
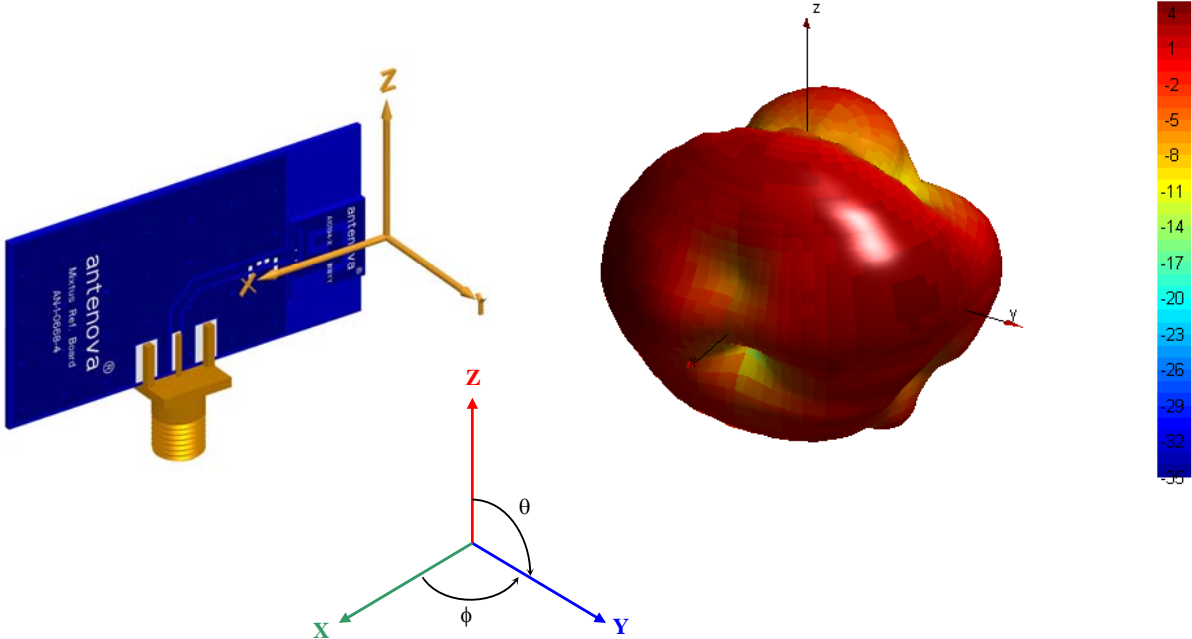

XY plane

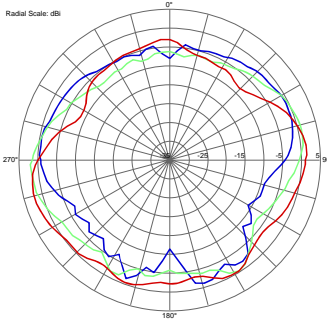

ZY plane

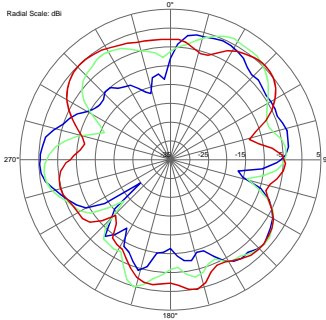

XZ plane

Patterns show combined polarisations  
 measured on reference board AN-1-0668-4

## 8 Antenna dimensions

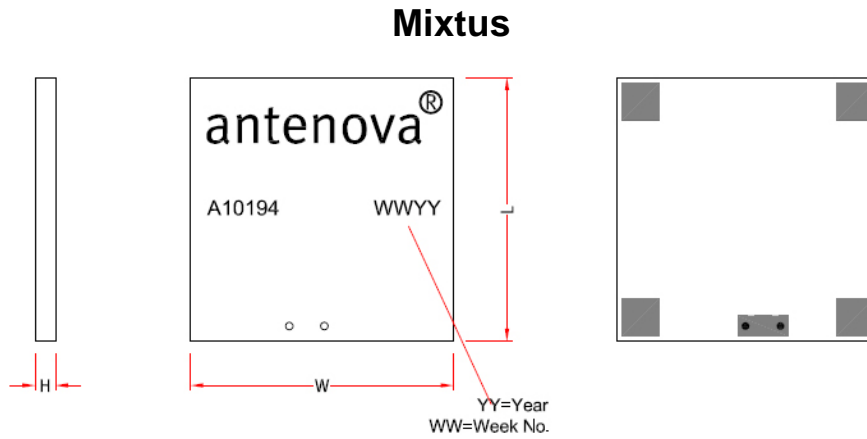

L	W	H
Length	Width	Height
$10.4 \pm 0.2$	$10.4 \pm 0.2$	$0.8 \pm 0.15$

Dimensions in mm

## 9 Antenna footprint

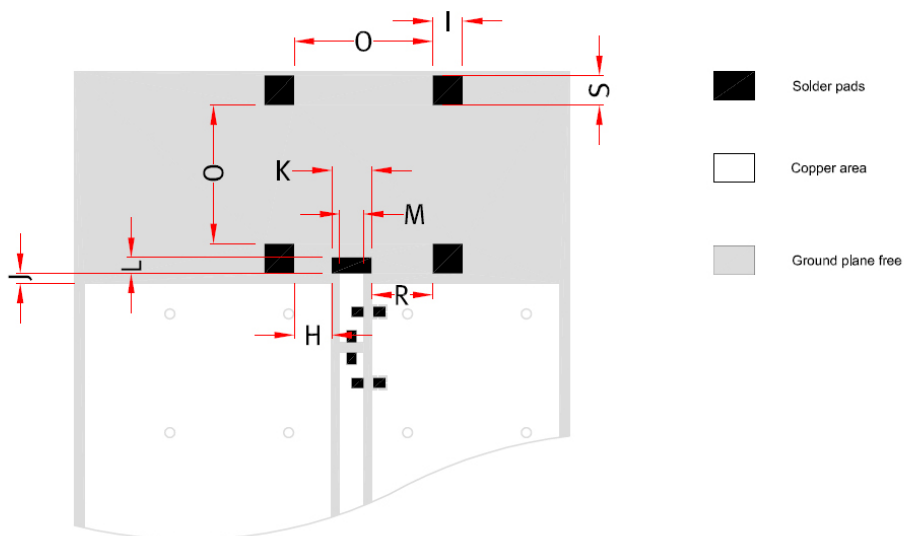

### Mixtus (Part No: A10194)

CAD files of the antenna footprint are available from Antenna on request.  
Please contact [info@antenna.com](mailto:info@antenna.com) for further details.

I	S	K	J	M	O	H	R	L
$1.5 \pm 0.1$	$1.5 \pm 0.1$	$2.0 \pm 0.1$	$0.5 \pm 0.1$	$1.2 \pm 0.1$	$7.0 \pm 0.1$	$1.9 \pm 0.1$	$3.1 \pm 0.1$	$0.8 \pm 0.1$

Dimensions in mm

## 10 Electrical interface

### 10-1 Transmission lines

- All transmission lines should be designed to have a characteristic impedance of  $50 \Omega$
- The length of the transmission lines should be kept to a minimum
- Any other parts of the RF system like transceivers, power amplifiers, etc, should also be designed to have an impedance of  $50 \Omega$

Once the material for the PCB has been chosen (PCB thickness and dielectric constant), a coplanar transmission line can easily be designed using any of the commercial software packages for transmission line design. For the chosen PCB thickness, copper thickness and substrate dielectric constant, the program will calculate the appropriate transmission line width and gaps on either side of the track so the characteristic impedance of the coplanar transmission line is  $50 \Omega$ .

### 10-2 Matching circuit

The antenna requires a matching circuit that must be optimized for each customer's product. The matching circuit will require up to three components and the following pad layout should be designed into the device so the correct circuit can be installed:

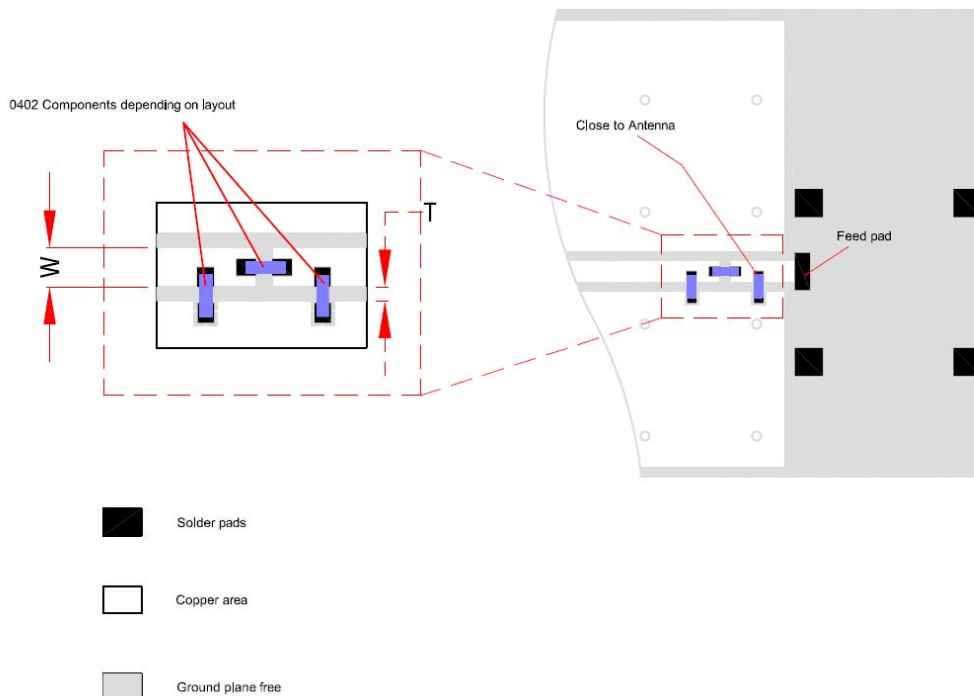

The antenna feed pad and the antenna ground pad are indicated in the drawing above. Additional pads are for mechanical attachment only and should not be grounded.

In addition to the matching circuit, a separate DC blocking capacitor will also be required between the radio and the antenna matching circuit.

**Note: The component values for the matching circuit will vary depending on the size of the PCB and surrounding components.** The impedance of the antenna should be measured before selecting suitable matching components. Antenova offers this service on request. Contact [info@antenova.com](mailto:info@antenova.com) for further information.

### 10-3 Antenna placement

Antenova strongly recommends placing the antenna near the edge of the board. Maximum antenna performance is achieved by placing the antenna towards one of the corners of the PCB and with the feed point of the antenna as close to the same corner of the PCB as possible.

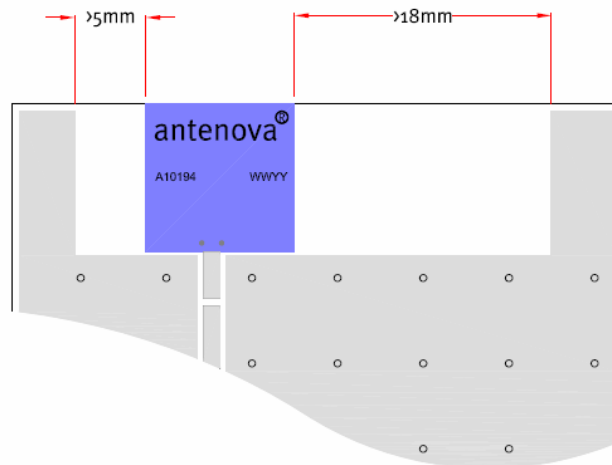

Additional ground and components near the antenna should be at a distance of at least 5 mm from the left hand side and 18 mm or more from the right hand side as shown in the drawing above.



## 10-4 Reference boards

The reference boards have been designed for evaluation purposes of Mixtus dual-band Wi-Fi SMD antenna and they include a SMA female connector

### Mixtus

Reference board part number: AN-1-0668-4

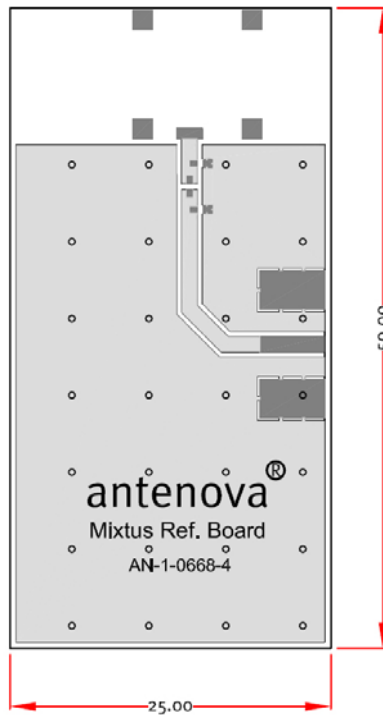

Dimensions in mm

To order a reference board contact [info@antenna.com](mailto:info@antenna.com)

## 11 Soldering

This antenna is suitable for lead free soldering.

The reflow profile should be adjusted to suit the device, oven and solder paste, while observing the following conditions:

- The maximum temperature should not exceed 240 °C
- However for lead free soldering, a maximum temperature of 255 °C for no more than 20 seconds is permitted.
- The antenna should not be exposed to temperatures exceeding 120 °C more than 3 times during the soldering process.

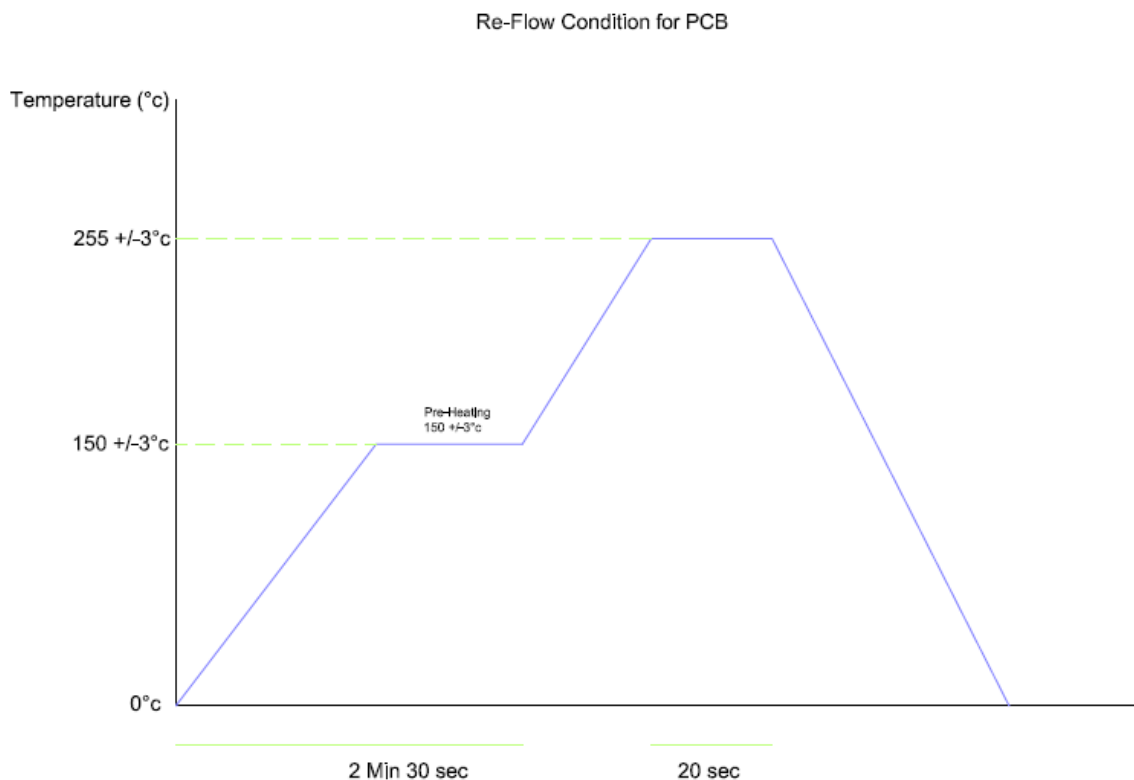

## 12 Hazardous material regulation conformance

The antenna has been tested to conform to RoHS requirements. A certificate of conformance is available from Antenova's website.

## 13 Packaging

### 13-1 Optimal storage conditions for packaged reels

Temperature	-10°C to 40°C
Humidity	Less than 75% RH
Shelf Life	18 Months
Storage place	Away from corrosive gas and direct sunlight
Packaging	Reels should be stored in unopened sealed manufacturer's plastic packaging.

Note: Storage of open reels of antennas is not recommended due to possible oxidation of pads on antennas. If short term storage is necessary, then it is highly recommended that the bag containing the antenna reel is re-sealed and stored in like storage conditions as in above table.

### 13-2 Tape characteristics

**Mixtus**  
[Part Number: A10194]

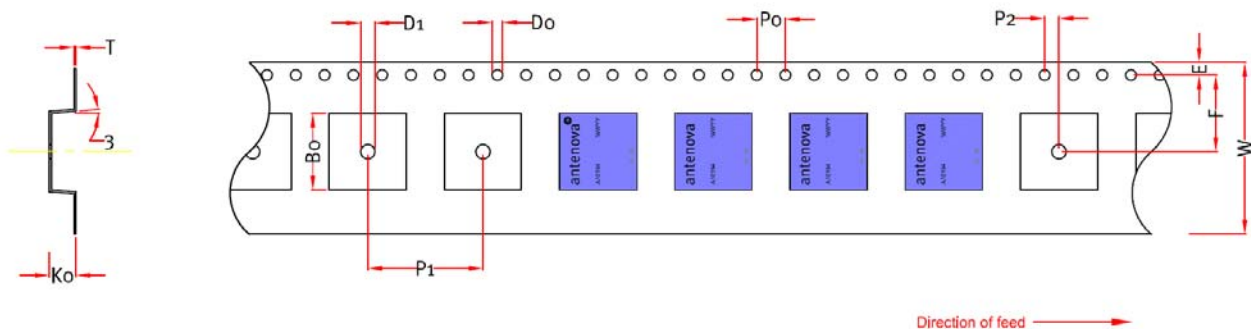

W	F	E	P0	P1	P2	B0	K0	T	D0	D1
24 ± 0.2	10.7 ± 0.1	1.75 ± 0.1	4.0 ± 0.1	16.0 ± 0.1	2.0 ± 0.1	10.7 ± 0.1	1.1 ± 0.1	0.3 ± 0.05	Min 1.55 ± 0.1	Min 2.0 ± 0.2

Dimensions in mm

Quantity	Leading Space	Trailing Space
2000 pcs / reel	50 blank antenna holders	50 blank antenna holders

### 13-3 Reel dimensions

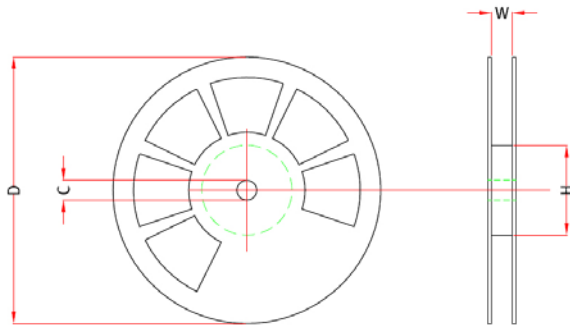

Width (W)	Reel Diameter (D)	Hub Diameter (H)	Shaft Diameter (C)
57.5 mm	330 mm ± 2.0	80 mm (2")	13.0 mm ± 0.5

### 13-4 Box dimensions



Width (W)	Breadth (B)	Thickness (H)
338 mm	335 mm	45 mm

### 13-5 Bag properties

Reels are supplied in protective plastic packaging

## 13-6 Reel label information

### Mixtus

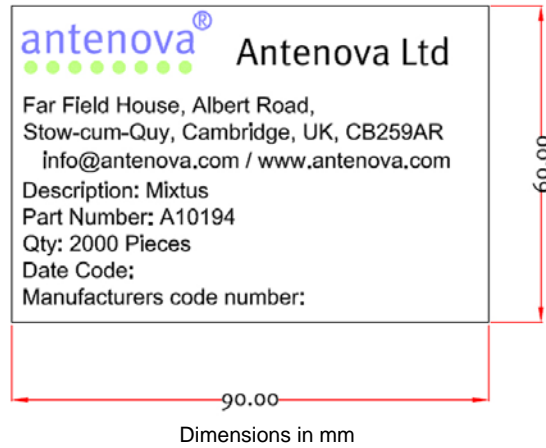



**[www.antenova.com](http://www.antenova.com)**

**Corporate Headquarters**

Antenova Ltd.  
Far Field House  
Albert Road  
Stow-cum-Quy  
Cambridge  
CB25 9AR

**Tel:** +44 1223 810600  
**Fax:** +44 1223 810650  
**Email:** [info@antenova.com](mailto:info@antenova.com)

**North America Headquarters**

Antenova Ltd.  
Rogers Business Park  
2541 Technology Drive Suite 403  
Elgin, IL 60124

**Tel:** +1 (847) 551 9710  
**Fax:** +1 (847) 551 9719  
**Email:** [info@antenova.com](mailto:info@antenova.com)

**Asia Headquarters**

Antenova Asia Ltd.  
4F, No. 324, Sec. 1, Nei-Hu Road  
Nei-Hu District  
Taipei 11493  
Taiwan, ROC

**Tel:** +886 (0) 2 8797 8630  
**Fax:** +886 (0) 2 8797 6890  
**Email:** [info@antenova.com](mailto:info@antenova.com)

**Copyright® 2008 Antenova Ltd.** All Rights Reserved. Antenova® and gigaNOVA® are trademarks of Antenova Ltd. Any other names and/or trademarks belong to their respective companies.

The materials provided herein are believed to be reliable and correct at the time of print. Antenova does not warrant the accuracy or completeness of the information, text, graphics or other items contained within these information. Antenova further assumes no responsibility for the use of this information, and all such information shall be entirely at the user's risk.



Certificate No: 4598

**Integrated Antenna and RF Solutions**