

Xinger®

Ultra Low Profile 0404 Balun 50Ω to 100Ω Balanced

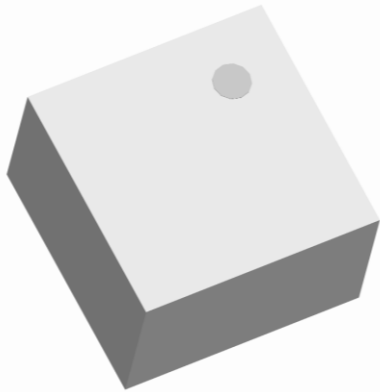

Description

The BD60120N50100AHF is a low cost, low profile sub-miniature unbalanced to balanced transformer designed for differential inputs and output locations on modern chipsets in an easy to use surface mount package for applications including point-to-point radio and wideband GaN. The BD60120N50100AHF is ideal for high volume manufacturing and delivers higher performance than traditional ceramic baluns. The BD60120N50100AHF has an unbalanced port impedance of 50Ω and a 100Ω balanced port impedance. This transformation enables single ended signals to be applied to differential ports on modern integrated chipsets. The output ports have equal amplitude (-3dB) with 180 degree phase differential. The BD60120N50100AHF is available on tape and reel for pick and place high volume manufacturing.

Detailed Electrical Specifications: Specifications subject to change without notice.

Features:	ROOM (25°C)												
	Frequency (GHz)	Port Impedance		Return loss (dB)		Insertion loss (dB)		Amplitude Balance (dB)		Phase Balance (deg)		CMRR (dB)	Power Handling (watts)
		Unbal.	Bal.	Typ.	Min.	Typ.	Max.	Typ.	Min.	Typ.	Max.	Typ.	Max.
<ul style="list-style-type: none"> • 5.9 – 11.7 GHz • Thin Height Profile • Ultra Low Insertion Loss • Surface Mountable • Tape & Reel • RoHS Compliant • Halogen Free • -55°C to 85°C 	5.9-8.5	50	100	22	15	0.4	0.6	0.8	1.2	9	11	21	TBD
	10.0-11.7	50	100	25	15	0.6	0.8	0.9	1.5	7	12	24	TBD

* Insertion Loss stated at room temperature (Insertion Loss is approximately 0.1 dB higher at +85 °C)

Outline Drawing

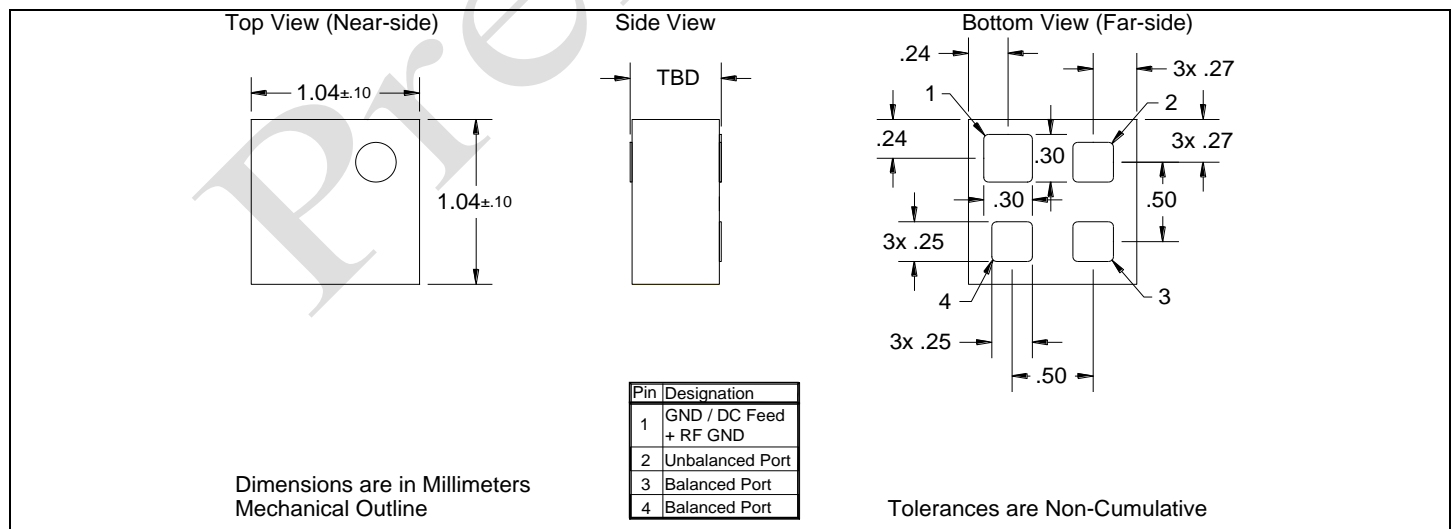

Preliminary Typical Performance: 6.0 GHz. to 12.0 GHz.

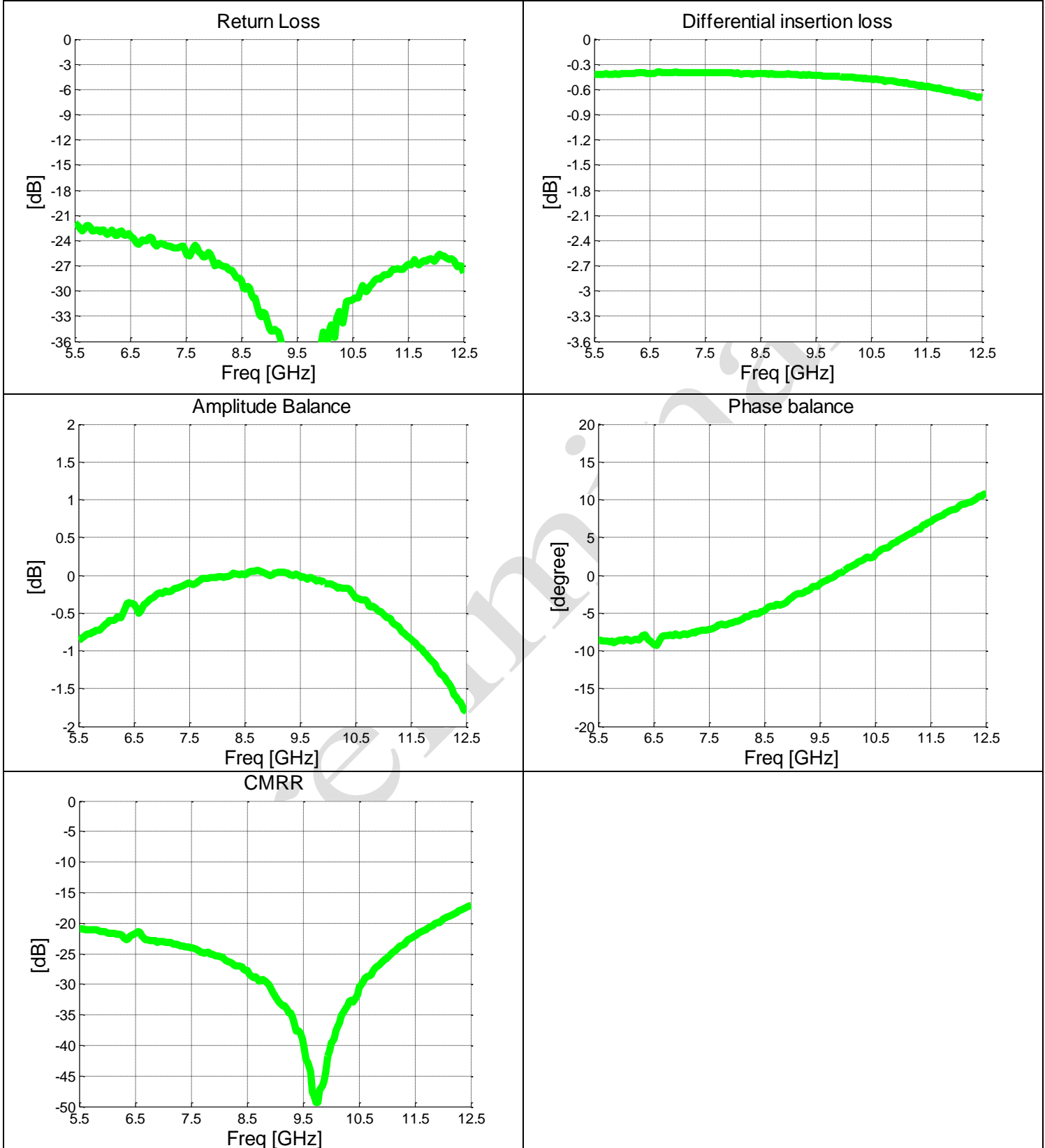

Preliminary Wide Band Performance: 4.0 GHz. to 14.0 GHz.

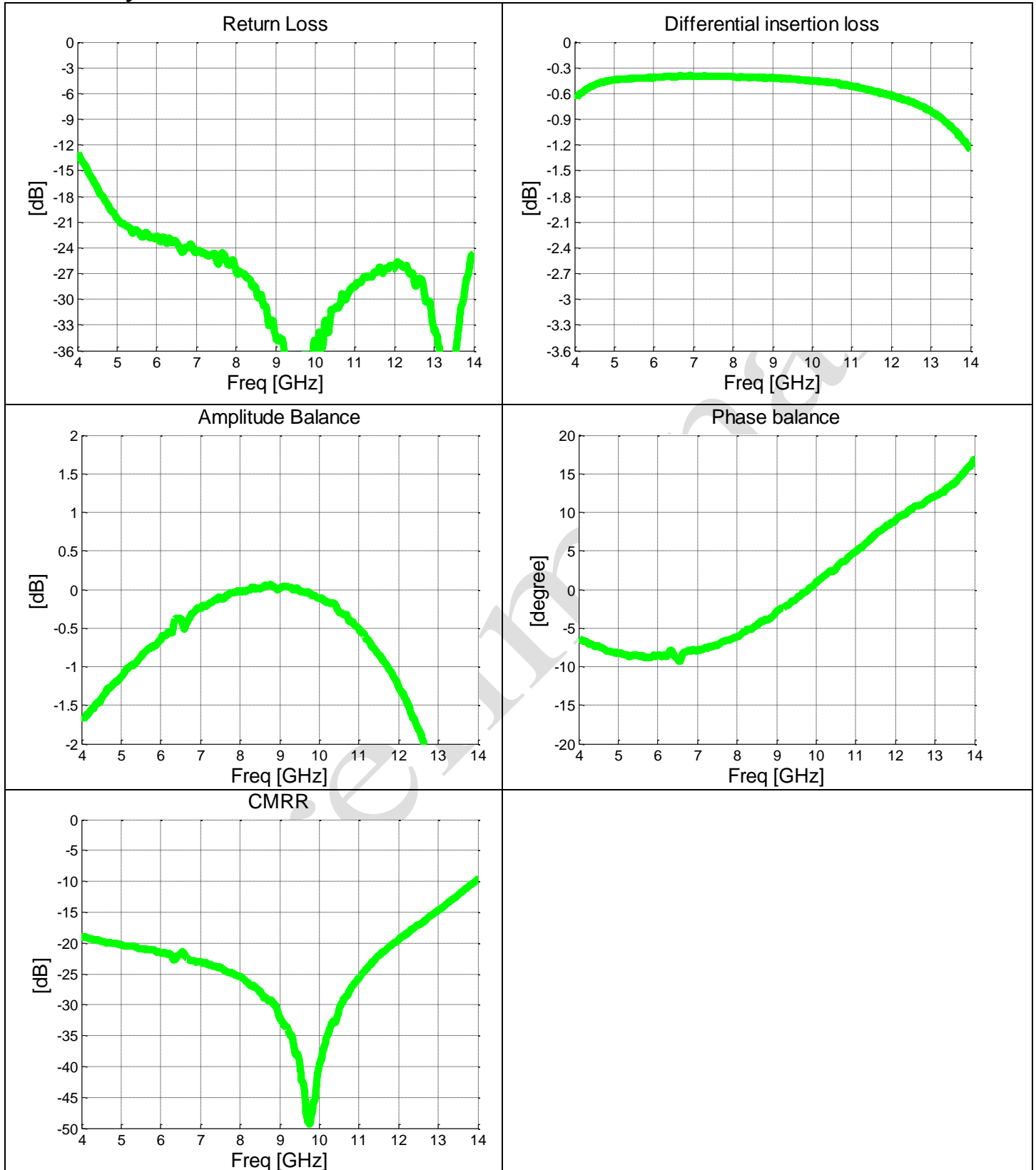

Mounting Configuration:

In order for Xinger surface mount components to work optimally, the proper impedance transmission lines must be used to connect to the RF ports. If this condition is not satisfied, insertion loss, Isolation and VSWR may not meet published specifications.

All of the Xinger components are constructed from organic PTFE based composites which possess excellent electrical and mechanical stability. Xinger components are compliant to a variety of ROHS and Green standards and ready for Pb-free soldering processes. Pads are Gold plated with a Nickel barrier.

An example of the PCB footprint used in the testing of these parts is shown below. In specific designs, the transmission line widths need to be adjusted to the unique dielectric coefficients and thicknesses as well as varying pick and place equipment tolerances.

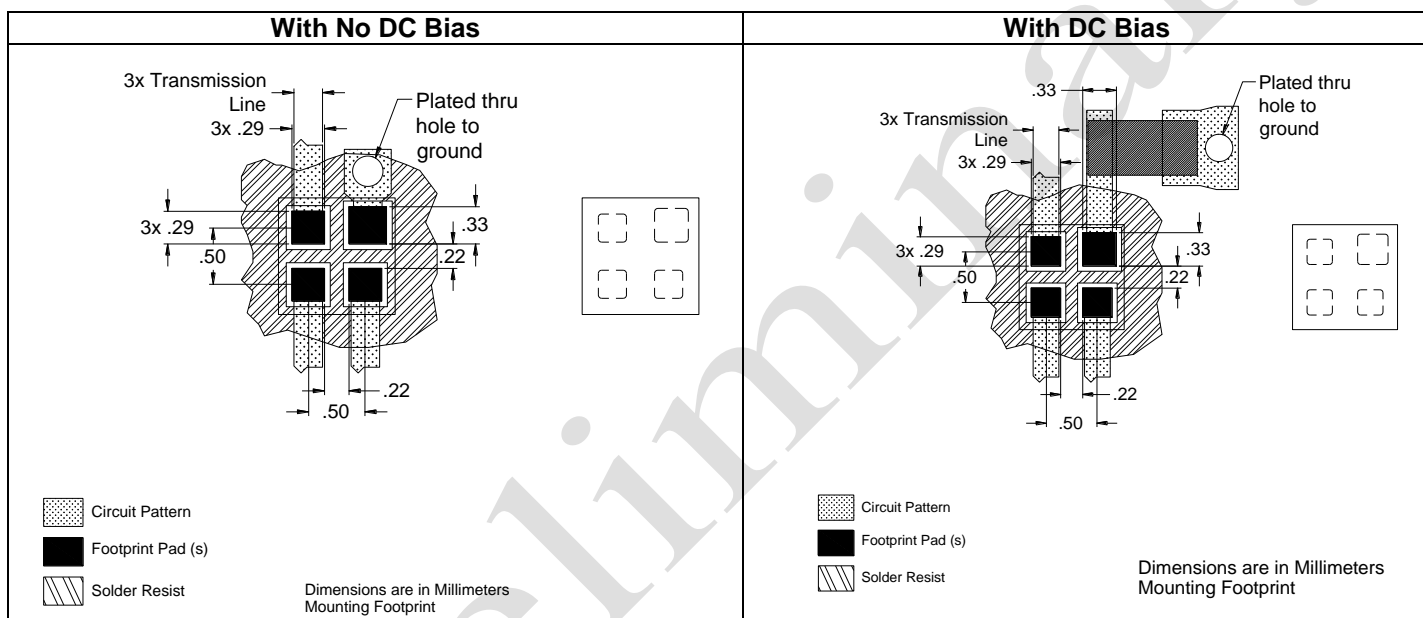

Packaging and Ordering Information

Parts are available in reel and are packaged per EIA 481-D. Parts are oriented in tape and reel as shown below. Minimum order quantities are 4000 per reel.

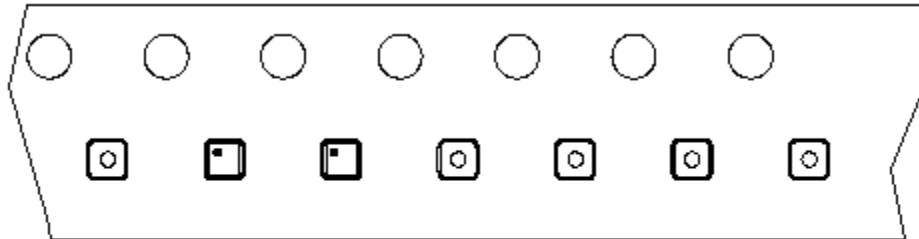

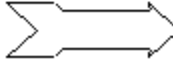
Direction of
Part Feed
(Unloading) 

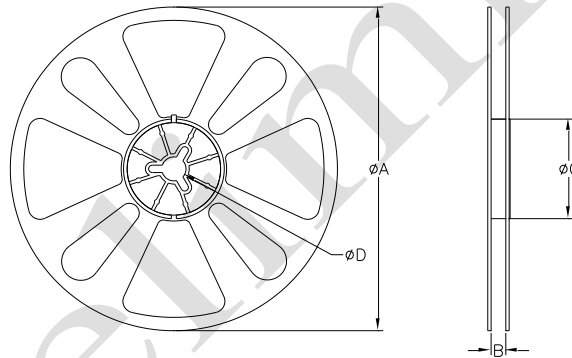

TABLE 1		
QUANTITY/REEL	REEL DIMENSIONS mm	
4000	φA	177.80
	B	8.00
	φC	50.80
	φD	13.00