

# AD9508 Evaluation Board User Guide

## Features

- Simple power connection using 6 V wall adapter and on-board LDO voltage regulators
- 8 ac-coupled single-ended SMA output connectors (4 differential paths)
- 2 ac-coupled single-ended SMA connectors for reference input
- Pin selectable options for the following:
  - 2.5 V or 3.3 V operation
  - SPI/I<sup>2</sup>C or Sx pin programmable
  - OUT0 through OUT3 divide value
  - OUT0 through OUT3 logic type
  - Input logic type
- USB connection to PC
- Microsoft Windows-based evaluation software with simple graphical user interface (supports 64-bit versions of Windows)

## Equipment Needed

- Reference oscillator or signal generator
- Other evaluation board to be clocked or test equipment
  - Converters, DDS, transceivers
  - Oscilloscope, spectrum analyzer, phase noise analyzer
- SMA cables (50 Ω)
- 6 V wall supply (provided)
- USB cable (provided)

## Online Resources

### Required Software

- [AD9508 evaluation board software](#)

### Documents Needed

- [AD9508 data sheet](#)

## General Description

---

The [AD9508](#) evaluation board is a compact, easy-to-use platform for evaluating all features of the [AD9508](#). This user guide focuses on the [AD9508](#) evaluation board and software. The [AD9508](#) is a high performance 1:4 flexible clock buffer. Each output has a programmable divider that can be set via SPI/I<sup>2</sup>C programming or Sx pin strapping. The [AD9508](#) features both 2.5 V and 3.3 V operation. For convenience, detailed information from the [AD9508](#) data sheet has been included in this user guide.

Use this guide in conjunction with the [AD9508](#) data sheet and software documentation available at [www.analog.com](http://www.analog.com).

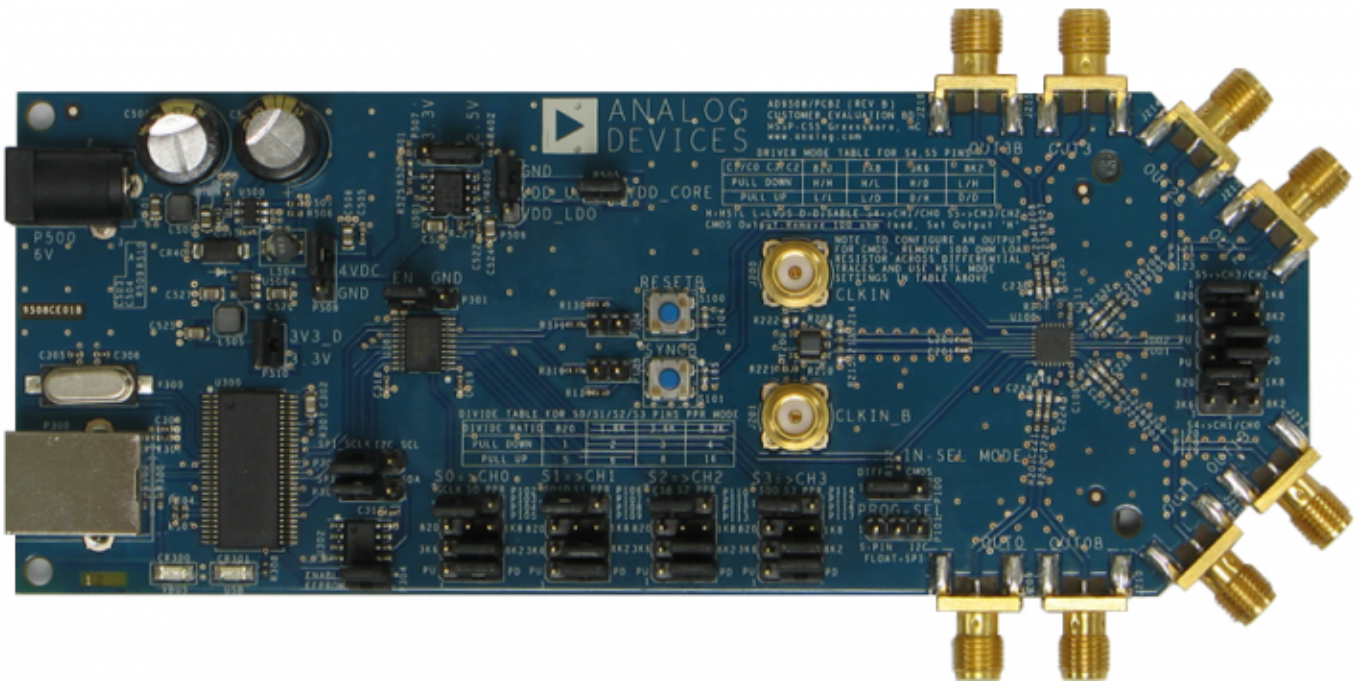

Figure 1. AD9508/PCBZ

## Evaluation Board Hardware

The following instructions are for setting up the physical connections to the AD9508/PCBZ evaluation board. Before connecting the evaluation board to a PC for the first time, the user must install the evaluation software.

### Power and PC Connections

1. Before installing the [AD9508](#) evaluation software, uninstall prior versions of the software. Administrative privileges are required for installation. The 64-bit versions of Windows® are supported.
2. Connect the 6 V wall power supply to the main power connector labeled P500.
3. Connect the USB cable to the evaluation board and the computer. The red LED labeled CR300 on the AD9508 evaluation board should illuminate.
4. If the **Found New Hardware Wizard** window appears when the evaluation board is connected, select **Install the software automatically** and click **Next**. The **Found New Hardware Wizard** window may appear twice, and a system restart may be required.
5. After the driver software has installed, the red LED labeled CR301 blinks.

## Signal Connections

To connect signals, connect a signal generator to the J200 (CLKIN) SMA connector. By default, the CLKIN input is connected to a balun for single-ended to differential conversion. This path is differentially terminated to 100  $\Omega$  and ac-coupled into the [AD9508](#) reference inputs. An amplitude setting of 0 dBm to 6 dBm is fine. The CLKIN\_B SMA input is grounded by default. To input a differential signal, the user must remove Balun T200 and Resistor R221, and replace Resistors R209 and R210 with 0  $\Omega$ . Connect an oscilloscope, spectrum analyzer, or other lab equipment to any of the J209 to J216 SMA clock OUTx connectors on the edge of the board. OUT0 through OUT3 are ac-coupled outputs differentially terminated to 100  $\Omega$ .

## Pin Programming and Jumper Settings

### Jumpers P507, P100, and P101

- Jumper P507 allows the user to select between 2.5 V and 3.3 V operation.
- Jumper P100 allows the user to select between differential and single-ended inputs.
- Jumper P101 allows the user to select the programming method (SPI/I<sup>2</sup>C/Sx pin programming) to be used by the [AD9508](#). Placing no jumper defaults the part to use the SPI. I<sup>2</sup>C programming is not currently supported with the evaluation board software. When pin programming is selected, Pin S0 through Pin S5 are used to determine various divider ratios and output modes for each of the [AD9508](#) outputs. Using the Sx pins to program the part gives the user limited control of each channel divider ratio and no control of phase offset. Refer to the [AD9508](#) data sheet for a complete overview regarding the use of the part with Sx pin programming.

### Jumpers P102, P106, P110, and P114

- Jumpers P102, P106, P110, and P114 connect and disconnect Pin S0 through Pin S3 to a SPI/I<sup>2</sup>C line. These must be set with respect to the setting of P101. Table 1 describes the proper placement of these jumpers.

**Table 1. P102, P106, P110, and P114 Jumper Settings with Respect to Jumper P101 Setting**

Programming Pin	Jumper Placement vs. Programming Method (SPI or I <sup>2</sup> C)	Pin Strapping
S0	P102 = SCLK	P102 = S0P
S1	P106 = SDIO	P106 = S1P
S2	P110 = $\overline{CS}$	P110 = S2P
S3	P114 = SDO	P114 = S3P

There are two more jumpers allocated for each Sx pin that are used to obtain all eight divider settings (for Pin S0 through Pin S3) and to select between logic types (Pin S4 and Pin S5). The first jumper is used to pull the Sx pin up to VDD or down to GND. The second jumper is used to select one of the four resistor settings on the evaluation board. Table 2 describes the possible divider and output mode settings when in Sx pin programming mode. Table 3 lists the jumper label associated with each divider ratio and driver mode setting.

**Table 2. Divider Ratio and Driver Mode Table for S0, S1, S2, S3, S4, and S5 Pins (Driver Modes Are Listed in the Order of CH1/CH2 or CH3/CH4)**

Programming Pins	Sx Pin Settings (0 Through 7) vs. Resistor Value vs. Divide Value and Logic Type								Description
	0 = 820 Ω Pulled to GND	1 = 1.8 kΩ Pulled to GND	2 = 3.9 kΩ Pulled to GND	3 = 8.2 kΩ Pulled to GND	4 = 820 Ω Pulled to VDD	5 = 1.8 kΩ Pulled to VDD	6 = 3.9 kΩ Pulled to VDD	7 = 8.2 kΩ Pulled to VDD	
S0	÷1	÷2	÷3	÷4	÷5	÷6	÷8	÷16	S0 is assigned to the CH0 divider ratio only
S1	÷1	÷2	÷3	÷4	÷5	÷6	÷8	÷16	S1 is assigned to the CH1 divider ratio only
S2	÷1	÷2	÷3	÷4	÷5	÷6	÷8	÷16	S2 is assigned to the CH2 divider ratio only
S3	÷1	÷2	÷3	÷4	÷5	÷6	÷8	÷16	S3 is assigned to the CH3 divider ratio only
S4	HSTL/HSTL	HSTL/LVDS	HSTL/Disable	LVDS/HSTL	LVDS/LVDS	LVDS/Disable	Disable/HSTL	Disable/Disable	S4 is assigned to CH0/CH1 to select their output logic types
S5	HSTL/HSTL	HSTL/LVDS	HSTL/Disable	LVDS/HSTL	LVDS/LVDS	LVDS/Disable	Disable/HSTL	Disable/Disable	S5 is assigned to CH2/CH3 to select their output logic types

**Table 3. Evaluation Board Sx Pin Jumper Labels**



Programming Pins	Evaluation Board Sx Pin Jumper Labels		
	820 $\Omega$ /1.8 k $\Omega$	3.9 k $\Omega$ /8.2 k $\Omega$	Pull Up to VDD/Pull Down to GND
S0	P103	P104	P105
S1	P107	P108	P109
S2	P111	P112	P113
S3	P115	P116	P117
S4	P118	P119	P120
S5	P121	P122	P123

## Evaluation Board Software

---

The [AD9508](#) evaluation software allows the user to control the full functionality of the [AD9508](#) through SPI/I<sup>2</sup>C communication on the evaluation board. Use the following instructions to set up the evaluation board software.

### Software Installation

Do not connect the evaluation board until the software installation is complete.

1. The latest evaluation software and documentation can be downloaded from <http://www.analog.com/eval-ad9508>.
2. On the [AD9508 evaluation board page](#), under **Software and Tools**, click **Evaluation Board AD9508 - Web Install** or **Evaluation Board AD9508 - Full Install**. The full version of the installer is a much larger file that contains the entire standalone installation for the .NET framework, and it does not require an Internet connection. The web installer contains an executable that can download the .NET framework, but this does require an Internet connection. However, if the .NET framework has already been installed, an Internet connection is not required to proceed.
3. Follow the installation instructions.

### Running the Software

Power up and connect the evaluation board to the PC. See the Evaluation Board Hardware section for details on the various connectors on the evaluation board.

1. Windows may automatically detect the evaluation board after the board is first plugged in. Allow Windows to install the device drivers.

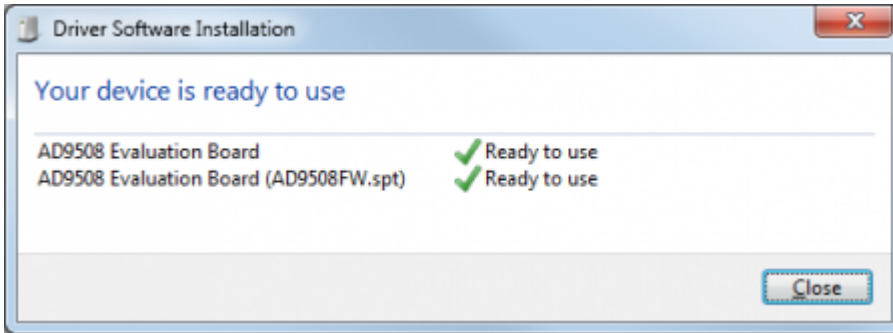

Figure 2. Device Hardware Installation

2. Double-click **AD9508 Evaluation Software** to run the AD9508 software. If the evaluation board is found by the software, the lower left corner of the main window (see Figure 4) displays **AD9508 Evaluation Board** in green. If the evaluation board is not found, the lower left corner of the window displays **No Hardware Connected!** in red.
3. If the evaluation board is found, proceed to the [Evaluation Software Components](#) section for details about running the software. If the evaluation board is not found, click **File > Select Hardware**. Select the appropriate [AD9508](#) evaluation board connected and click **OK** (see Figure 3).

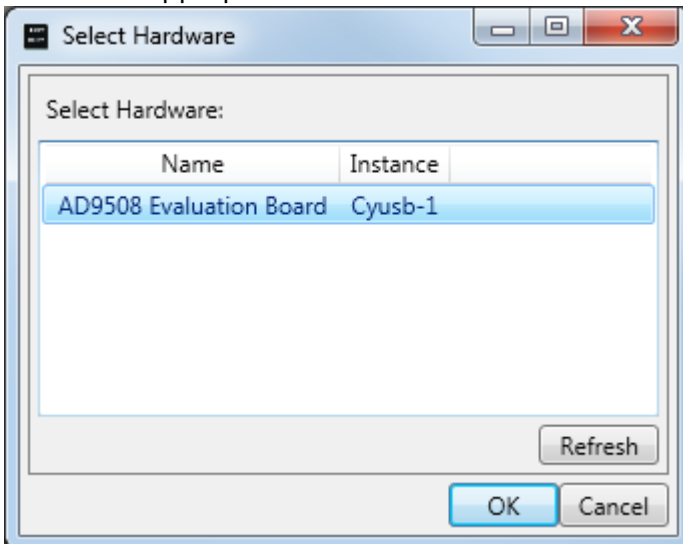

Figure 3. Select Hardware Window

The bottom left corner of the main window should now display **AD9508 Evaluation Board** in green. Alternatively, you can use the software in standalone mode. The standalone mode is useful for verifying register settings for a given setup. See the [Evaluation Software Components](#) section for a description of the evaluation software features.

## Evaluation Software Components

---

### Main Window

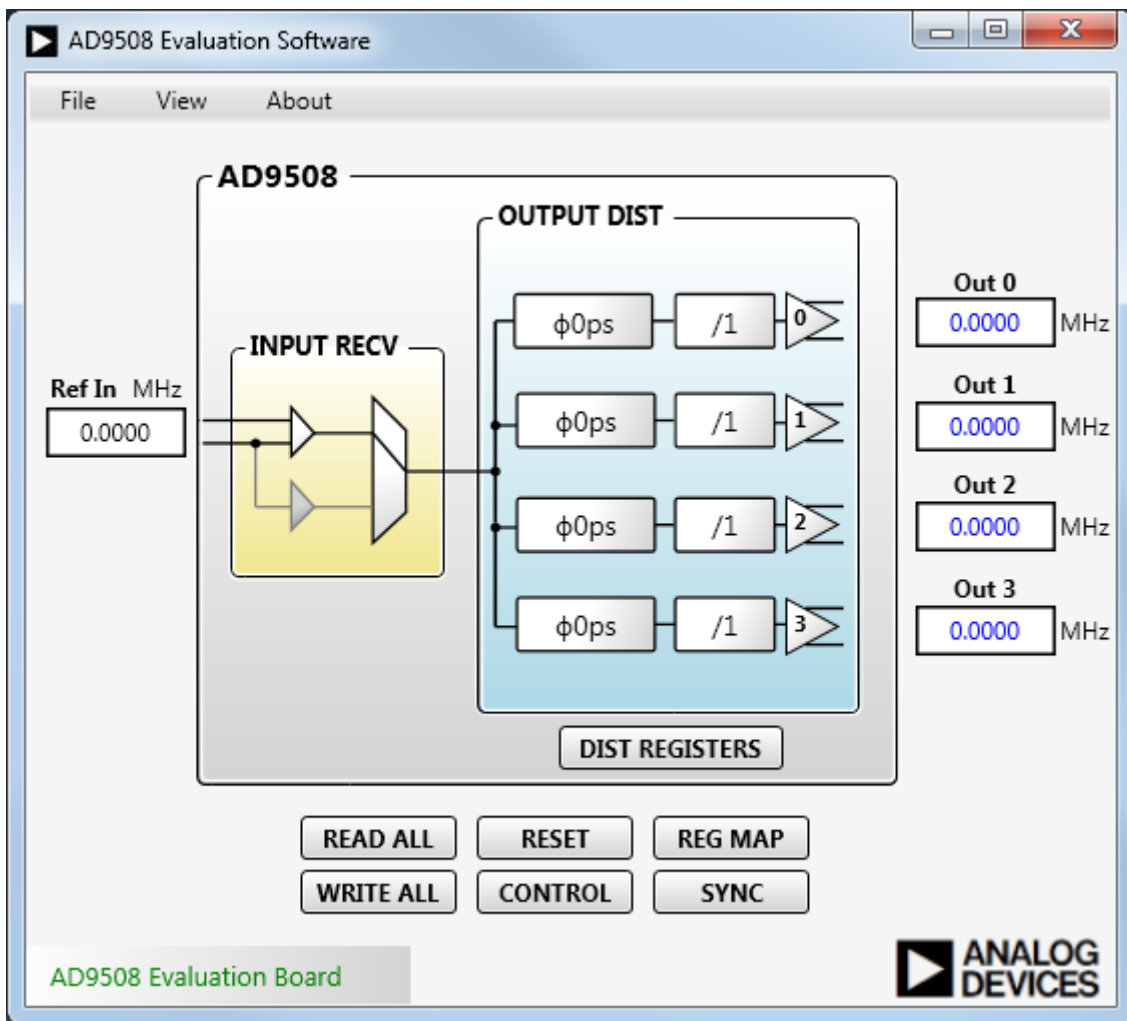

Figure 4. Evaluation Software Main Window

The [AD9508](#) evaluation software is composed of subsections that correspond to the major functional blocks of the [AD9508](#). These subsections are described in the following sections of the user guide. Some of the subsections have dedicated windows that allows the user to edit the register settings associated with a functional block. For example, the output distribution functional block window can be accessed by clicking the **DIST REGISTER** button. Some of the functional blocks have editable text areas that can be accessed and altered without opening each functional block window. Altering these text areas changes the settings found in the various block windows and immediately loads the change into the evaluation board. Conversely, edits to the settings within a block are reflected in the respective text area.

After clicking **Load**, the settings from that subwindow are loaded to the evaluation board. When editing a text box within the main window, the **ENTER** key must be pressed before a change is saved and loaded into the evaluation board.

## Input Receiver

The input receiver (**INPUT RECV**) section allows the user to select between single-ended and differential operation. Click the mux symbol within the block to highlight the active path (see Figure

5). The left image in Figure 5 shows the default differential operation of the input receiver. The right image shows single-ended operation.

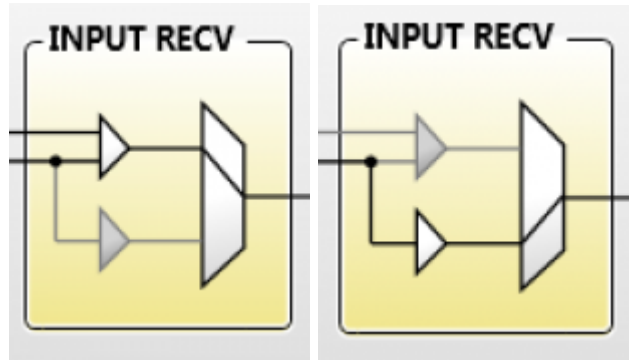

Figure 5. Input Receiver Section

Left Image: Default Differential Operation of Input Receiver; Right Image: Single-Ended Operation

## Output Distribution

The output distribution (**OUTPUT DIST**) section allows the user to alter divide ratios and phase offsets for each output of the [AD9508](#). Each divide and phase block can be edited by typing the preferred value within the block, and then pressing the **ENTER** key. When **ENTER** is pressed, the values are loaded into the evaluation board. The phase offset blocks accept the u (micro), p (pico), and n (nano) prefixes. Phase offset is limited to one half of the period of the input clock rate. Each divider supports integer divide values from 1 to 1024. If the typed value is not achievable in the current configuration, the software automatically rounds to the nearest possible solution. The output distribution section is shown in Figure 6.

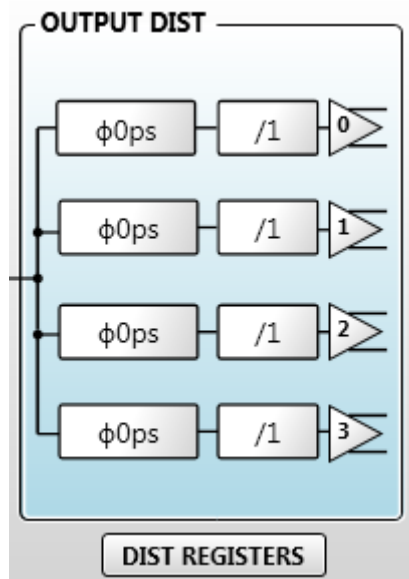

Figure 6. Output Distribution Section

Clicking the **DIST REGISTERS** button at the bottom of the output distribution section allows the user



to access all of the distribution register settings in the **Distribution Settings** window (see Figure 7).

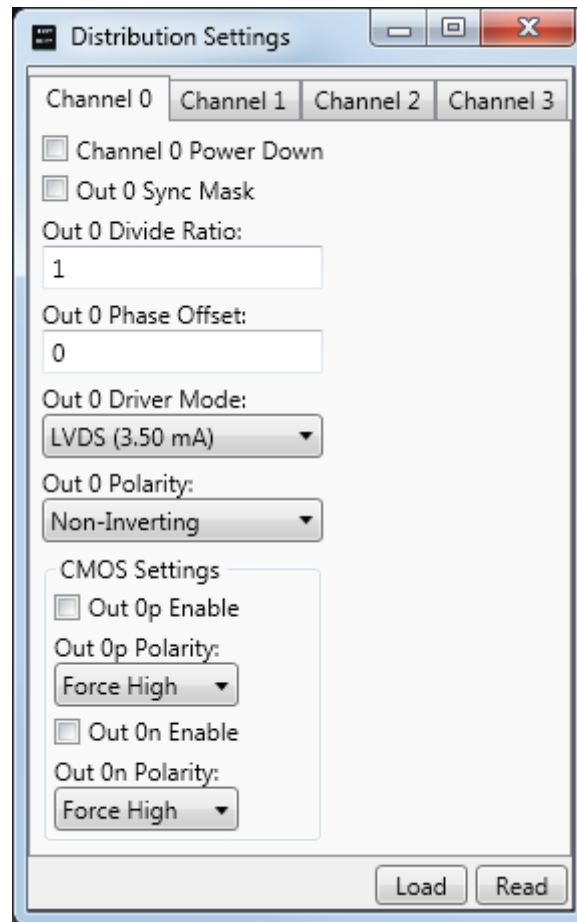

Figure 7. Distribution Settings Window

The **Distribution Settings** window consists of four individual tabs for each output channel. Each tab contains controls for each channel divide ratio, phase offset, driver mode, polarity and power-down settings. To load any of the settings to the evaluation board changed within the **Distribution Settings** window, the user must click the **Load** button.

The driver mode and polarity settings are altered by selecting one of the values from the respective drop-down box and clicking the **Load** button. To power down a channel driver, the appropriate channel power-down box must be selected.

## Operational Controls Window

The **Operational Controls** window is opened by clicking the **CONTROL** button at the bottom of the main window. This window contains controls for SPI configuration, LDO voltage control, channel power-down, sleep mode, and two buttons for soft reset and soft sync. The **Operational Controls** window is shown in Figure 8.

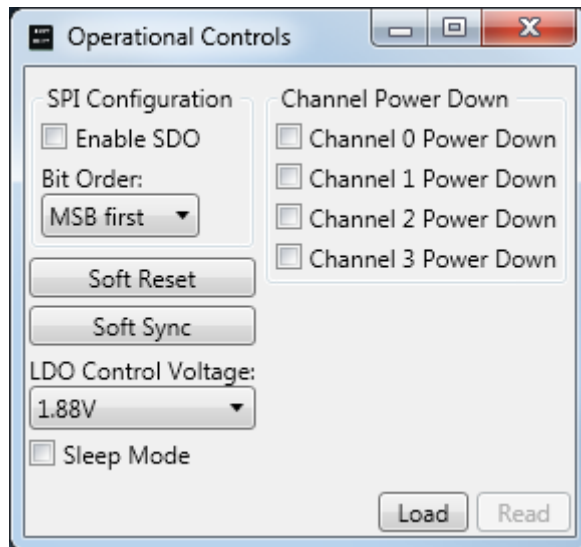

Figure 8. Operational Controls Window

## Register Map Window

The **Register Map** window is accessed by clicking the **REG MAP** button at the bottom of the main window. Figure 9 shows the **Register Map** window.

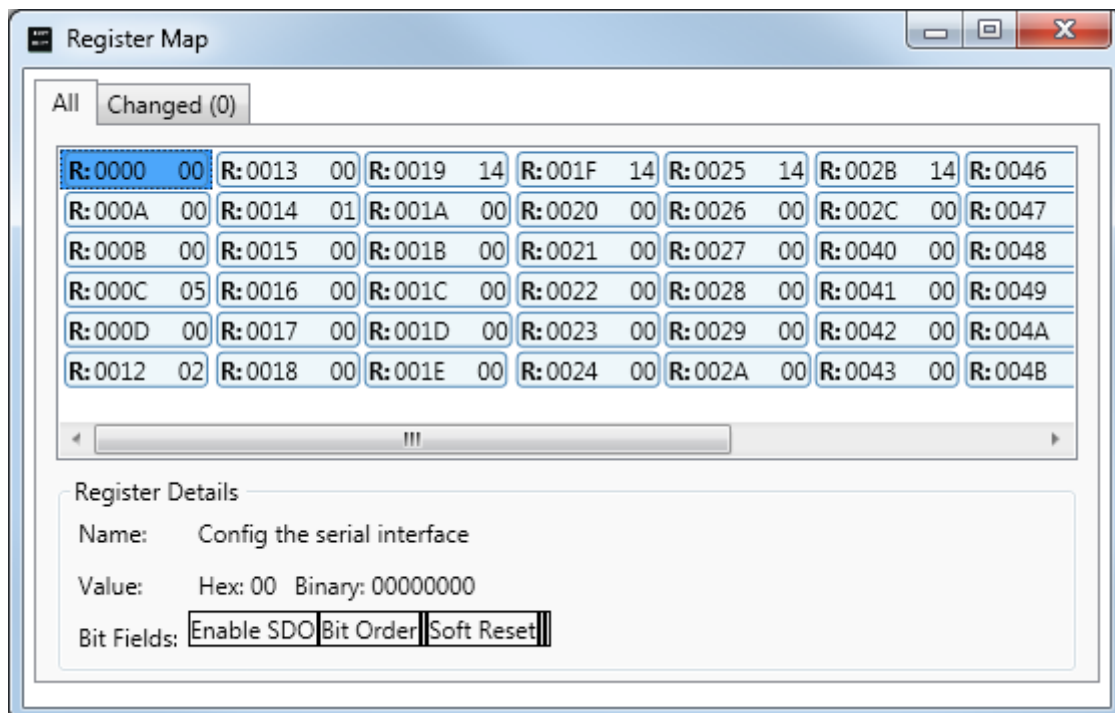

Figure 9. Register Map Window

The **Register Map** window contains two tabs. The **All** tab displays all of the registers that can be changed through the [AD9508](#) evaluation software. Each register can be selected by clicking the various blue boxes shown in Figure 9. Register details for the selected register appear at the bottom of the window. These details include the name of the register, the current register value, and the

various bit fields for the register. The **Changed** tab contains all of the registers that have been modified from within the [AD9508](#) evaluation software but not loaded into the evaluation board yet. These same registers are also highlighted in the **All** tab as they are modified.

## READ ALL and WRITE ALL Buttons

The **READ ALL** and **WRITE ALL** buttons are located at the bottom of the main window. Click the **READ ALL** button to read all of the register values currently stored in the chip and transfer them to the evaluation software. Click the **WRITE ALL** button to transfer all of the register values currently loaded into the software and write them to the chip.

## Reset Button

The **Reset Button** is located at the bottom of the main window. Clicking this button resets the part to its default register settings, which is also reflected in the main window.

## SYNC Button

Click the **SYNC** button to issue a soft synchronization command, which synchronizes all outputs that are not omitted by the appropriate SYNCMASKx bit. Refer to the [AD9508](#) data sheet for more information about the sync command.

## Evaluation Software Menu Items

---

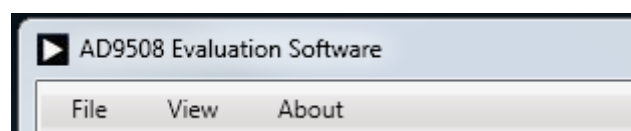
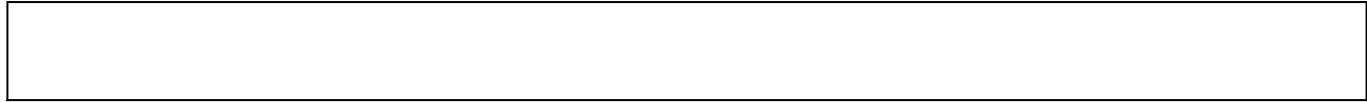

*Figure 10. Menu Bar*

## File Menu

The **File** menu includes the following options:

- Load Setup
- Save Setup
- Select Hardware



- Options
  - Enable Polling
  - Polling Interval
- Exit

### Load Setup

Selecting **Load Setup** loads a previously saved **AD9508** setup file (.stp). A setup file is a text file that contains the **AD9508** register setup file, plus any evaluation board settings.

### Save Setup

Selecting **Save Setup** saves an **AD9508** setup file (.stp). A setup file is a text file that contains the **AD9508** register settings, plus any evaluation board settings.

### Select Hardware

The **AD9508** evaluation system allows one PC to control multiple evaluation boards. This window allows the user to select the evaluation board that the software is controlling. Click the **Refresh** button to detect a recently connected evaluation board.

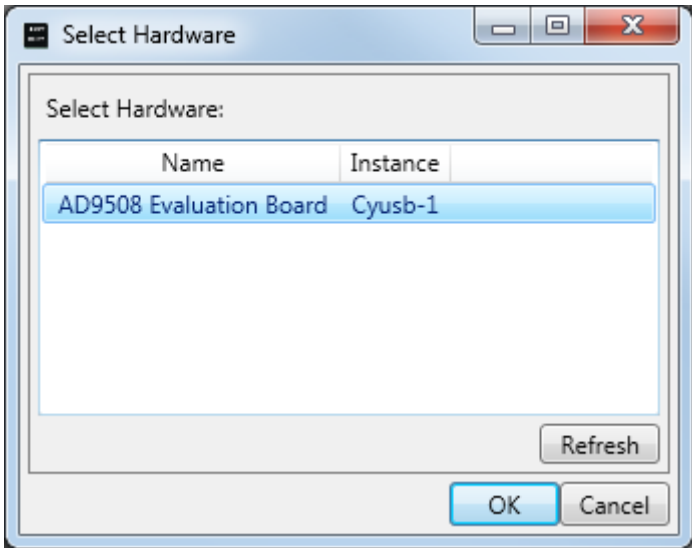

Figure 11. Select USB Device Window

### Options (Enable Polling and Polling Interval)

Polling allows the user to define how often the software checks for changes made to the register values on the [AD9508](#). Polling also checks for a hardware connection, which updates in the lower left corner of the main window. The polling interval window sets the length of time between each software check. The default interval is 1 sec. Figure 12 shows the polling interval selection window.

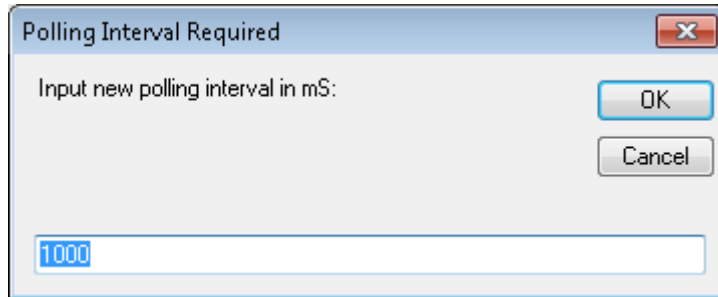

Figure 12. Polling Interval Window

## Exit

Exits the evaluation software. No checking is performed to ensure that the existing setup is saved.

## View Menu

The **View** menu includes the following options:

- Register Map
- Debug

## Register Map

Opens the **Register Map** window. See the [Register Map Window](#) subsection in the [Evaluation Software Components](#) section.

## Debug

The **Debug** window allows the user to read the values that are loaded into the various register addresses as well as manually load values into each register address of the [AD9508](#) on the evaluation board. Figure 13 shows the **Debug Window**. Detailed information about the usable registers and their functions can be found in the [AD9508](#) data sheet.

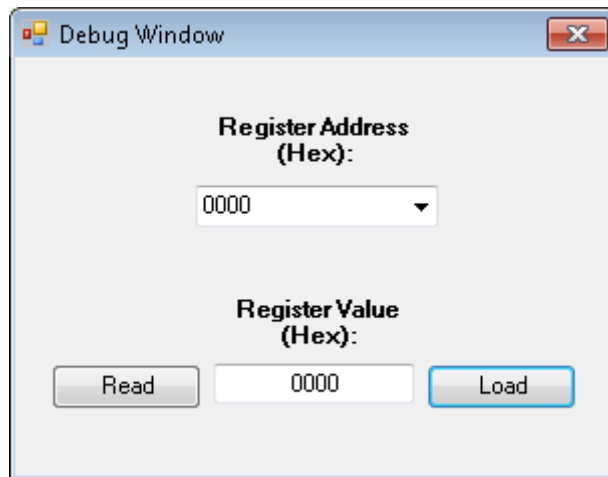

Figure 13. Debug Window

## About Menu

Selecting **About** opens the [AD9508](#) window, which contains information about the version of the evaluation board software.

---

I<sup>2</sup>C refers to a communications protocol originally developed by Philips Semiconductors (now NXP Semiconductors).

© Analog Devices, Inc. All rights reserved. Trademarks and registered trademarks are the property of their respective owners.



[www.analog.com](http://www.analog.com)