



PART NO.

10116040-001LF

NOTES:

- MATERIAL:
HOUSING: HIGH PERFORMANCE RESIN, GLASS FILLED, UL94 V-0, COLOR: NATURAL.
TERMINAL: TI-CU ALLOY.
CAP: STAINLESS SLEEEL.
HOLDDOWN: STAINLESS SLEEEL.
- FINISH:
TERMINAL:
CONTACT AREA: GOLD PLATED 30u" MIN.
ALL AREA: GOLD PLATED 1u" MIN.
UNDER NICKEL PLATED 50u" MIN.
HOLDDOWN:
ALL AREA: GOLD PLATED 1u" MIN.
UNDER NICKEL PLATED 50u" MIN.
- NORMAL FORCE: 1.25N Min. FOR 1.6mm COMPRESSION.
- THE PRODUCT SPEC. PLS. REFER TO GS-12-674.
- THE PACKING SPEC. PLS. REFER TO GS-14-1545.
- THE SUFFIX "LF" MEANS FOR LEAD FREE PROCESS.

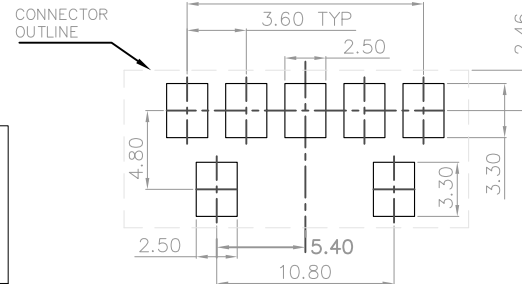
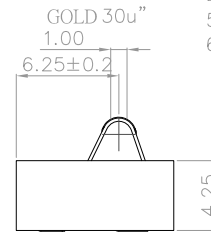
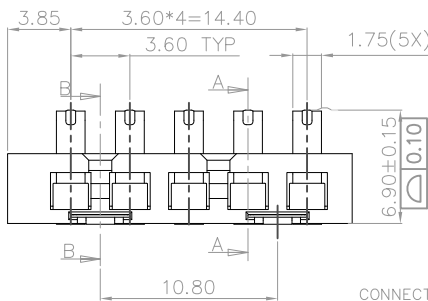
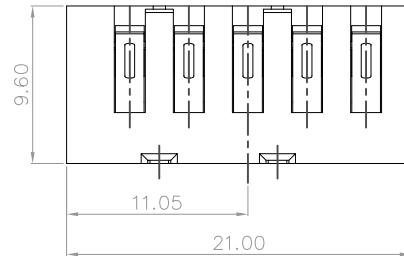
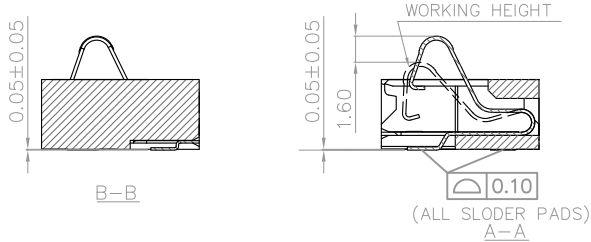

RECOMMENDED P.C.B.LAYOUT
TOLERANCE: +/-0.05

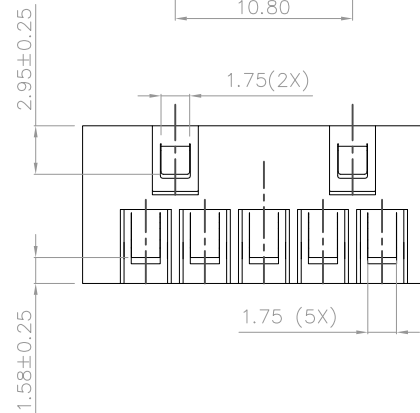
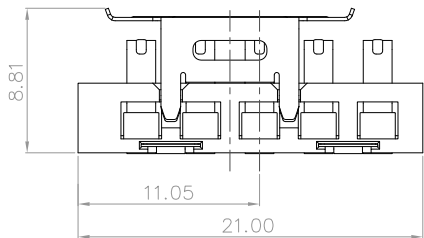
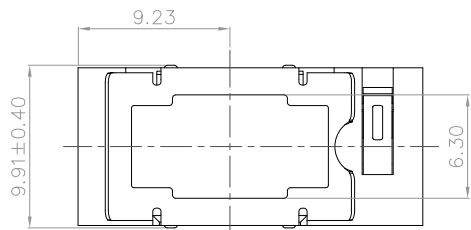
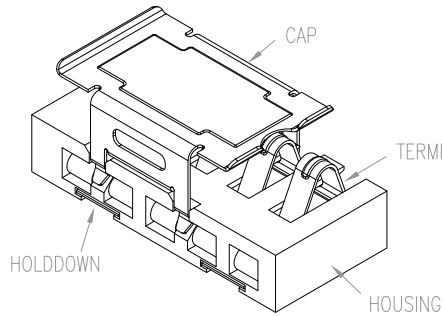
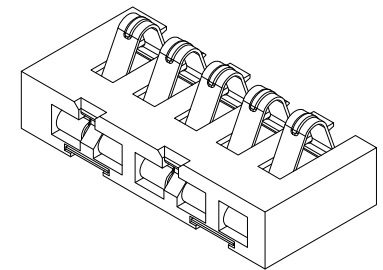

mat'l. code		surface ASME Y14.5		tolerance ASME Y14.5		projection MM		product family BATTERY	
ltr ecn no dr date		tolerances unless otherwise specified		angles		scale		title	
A	T10-0130	LS	01-19-11	0.25	1°			5 PINS 3.60mm PITCH BATTERY CONNECTOR	
				.XX±0.15		FCI		dwg no 10116040	
				.XXX±0.10				sheet 1 of 1 size A4	
		dr LEIF SHEN 01-19-11		engr LEIF SHEN 01-19-11				type CUSTOMER Drawing	
		chr GARY HSIEH 01-19-11		appd JOSEPH HSIA 01-19-11					
sheet index	revision sheet	A	1						