



This document is the property of Amphenol Corporation and is delivered on the express condition that it is not to be disclosed, reproduced or used, in whole or in part, for manufacture or sale by anyone other than Amphenol Corporation without its prior consent, and that no right is granted to disclose or to use any information in this document.

The marking on this product doesn't contain environmental hazardous materials per Material Specification SS-00259 for Sony GP compliant or per directive 2011/65/EU for RoHS compliant.



ORIGINAL



REVISIONS				
SYM	ECN No.	DESCRIPTION	DATE	APPROVED
A	NE-15011	NON-RELEASE REVISION	01/23/2015	Arron Lin

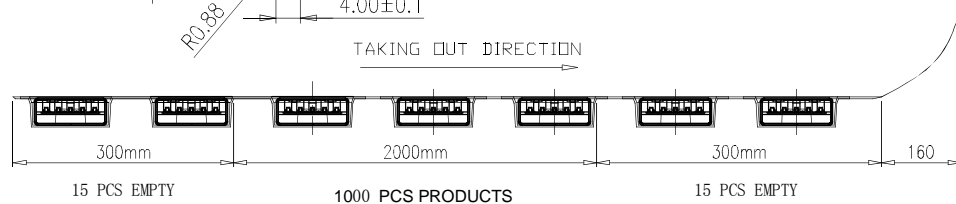
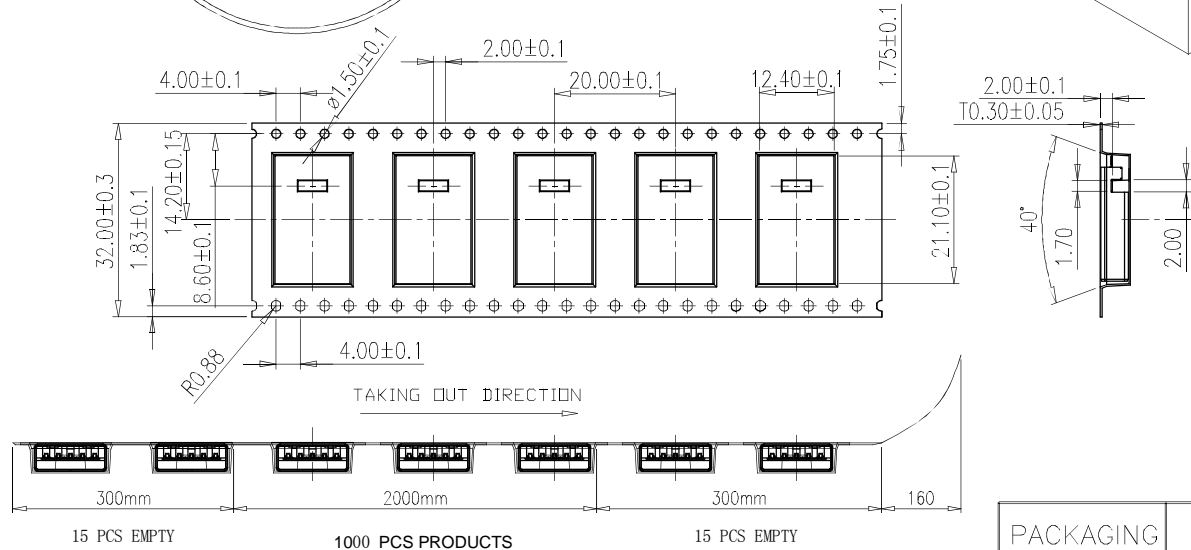
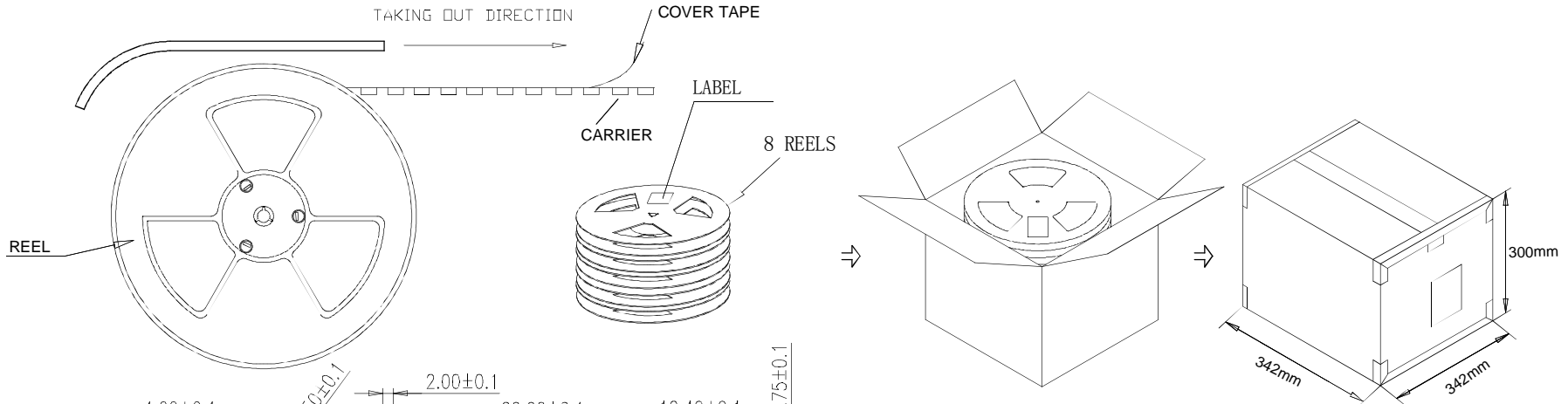

PACKAGING BY T&R	16.5	16	1000	8	8000	GSB4164X5CHR
	G/W KG	N/W KG	PCS/ REEL	REELS/ BOX	QUANTITY (PCS)	PART NUMBER

TOLERANCE	APPROVALS	DATE	TITLE			
X. ±0.30	DRAWN Debby Hung	01/23/2015	USB 3.0 A TYPE PLUG, SMT 0.3mm OFFSET CENTER LINE.			
X.X ±0.20		CHECKED Roger Tsai				
X.XX ±0.10	APPROVED Arron Lin	01/23/2015	UNIT mm	SIZE A3	PART No. GSB4164X5CHR	
ANGULAR ±1°	DWG TYPE CUST DWG	PROJECT CODE OTHER	SCALE NA	SHEET 2 OF 3	DWG No. GSB4164X5XHR	REV. A

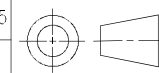

**Amphenol**<sup>®</sup>  
Amphenol Corporation  
Amphenol Taiwan Corporation

This document is the property of Amphenol Corporation and is delivered on the express condition that it is not to be disclosed, reproduced or used, in whole or in part, for manufacture or sale by anyone other than Amphenol Corporation without its prior consent, and that no right is granted to disclose or to use any information in this document.

The marking on this product doesn't contain environmental hazardous materials per Material Specification SS-00259 for Sony GP compliant or per directive 2011/65/EU for RoHS compliant.



ORIGINAL



REVISIONS				
SYM	ECN No.	DESCRIPTION	DATE	APPROVED
A	NE-15011	NON-RELEASE REVISION	01/23/2015	Arron Lin

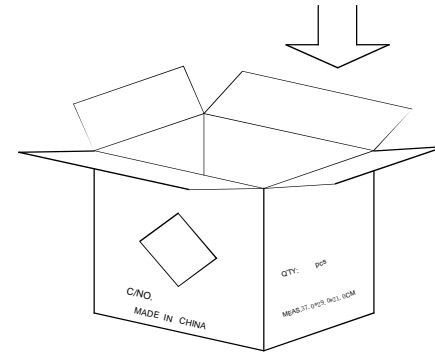
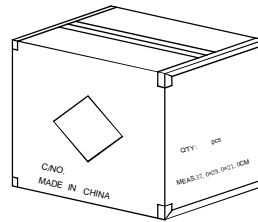
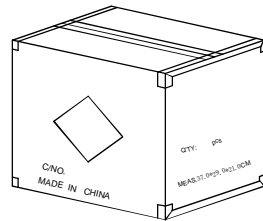
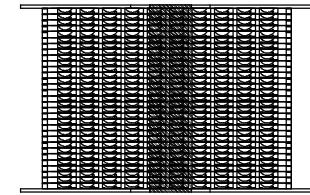
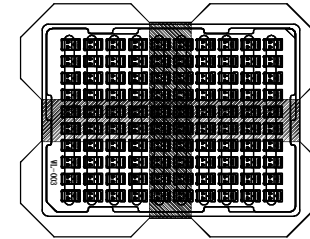
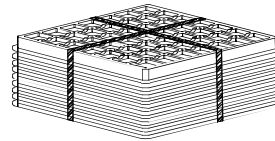
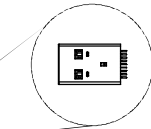
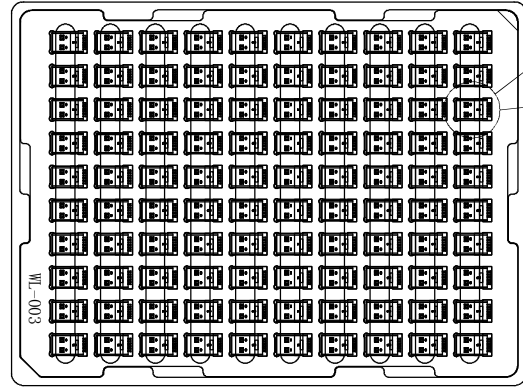

NOTES:  
1. CARTON SIZE: 370 X 290 X 210 mm

PACKAGING BY TRAY	10	7.2	100	30	3000	GSB4164X53HR
	G/W KG	N/W KG	PCS/ TRAY	TRAYS/ BOX	QUANTITY (PCS)	PART NUMBER

TOLERANCE	APPROVALS	DATE	TITLE	
X. X.X ±0.30 X.XX ±0.20 X.XXX ±0.10	DRAWN Debby Hung	01/23/2015	USB 3.1 A TYPE PLUG, SMT 0.3mm OFFSET CENTER LINE.	
	CHECKED Roger Tsai	01/23/2015		
	APPROVED Arron Lin	01/23/2015		
ANGULAR ±1°	DWG TYPE CUST DWG	PROJECT CODE OTHER		UNIT mm    SIZE A3 SCALE NA    SHEET 3 OF 3
UNLESS OTHERWISE SPECIFIED			PART No. GSB4164X5XHR DWG No. GSB4164X5XHR    REV. A	

Amphenol®

Amphenol Corporation  
Amphenol Taiwan Corporation