



## AO8807L

### Dual P-Channel Enhancement Mode Field Effect Transistor

#### General Description

The AO8807L uses advanced trench technology to provide excellent  $R_{DS(ON)}$ , low gate charge and operation with gate voltages as low as 1.8V. This device is suitable for use as a load switch.

- RoHS Compliant
- Halogen Free

#### Features

- $V_{DS}$  (V) = -12V
- $I_D$  = -6.5 A ( $V_{GS}$  = -4.5V)
- $R_{DS(ON)} < 20m\Omega$  ( $V_{GS}$  = -4.5V)
- $R_{DS(ON)} < 24m\Omega$  ( $V_{GS}$  = -2.5V)
- $R_{DS(ON)} < 30m\Omega$  ( $V_{GS}$  = -1.8V)

**ESD Protected!**

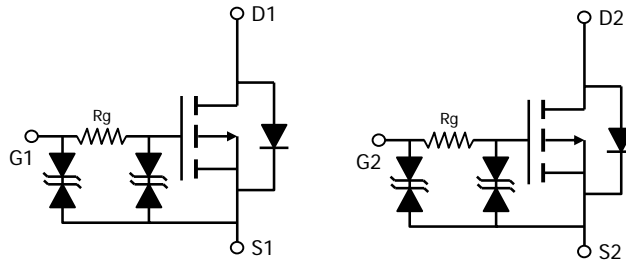
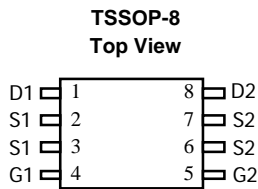

#### Absolute Maximum Ratings $T_A=25^\circ\text{C}$ unless otherwise noted

Parameter	Symbol	Maximum	Units
Drain-Source Voltage	$V_{DS}$	-12	V
Gate-Source Voltage	$V_{GS}$	$\pm 8$	V
Continuous Drain Current	$I_D$	$T_A=25^\circ\text{C}$	-6.5
		$T_A=70^\circ\text{C}$	-5
Pulsed Drain Current <sup>C</sup>	$I_{DM}$	-60	A
Power Dissipation <sup>B</sup>	$P_D$	$T_A=25^\circ\text{C}$	1.4
		$T_A=70^\circ\text{C}$	0.9
Junction and Storage Temperature Range	$T_J, T_{STG}$	-55 to 150	$^\circ\text{C}$

#### Thermal Characteristics

Parameter	Symbol	Typ	Max	Units
Maximum Junction-to-Ambient <sup>A</sup>	$R_{\theta JA}$	73	90	$^\circ\text{C/W}$
Maximum Junction-to-Ambient <sup>AD</sup>		96	125	$^\circ\text{C/W}$
Maximum Junction-to-Lead	$R_{\theta JL}$	63	75	$^\circ\text{C/W}$

**Electrical Characteristics (T<sub>J</sub>=25°C unless otherwise noted)**

Symbol	Parameter	Conditions	Min	Typ	Max	Units
<b>STATIC PARAMETERS</b>						
BV <sub>DSS</sub>	Drain-Source Breakdown Voltage	I <sub>D</sub> =-250μA, V <sub>GS</sub> =0V	-12			V
I <sub>DSS</sub>	Zero Gate Voltage Drain Current	V <sub>DS</sub> =-12V, V <sub>GS</sub> =0V T <sub>J</sub> =55°C			-1 -5	μA
I <sub>GSS</sub>	Gate-Body leakage current	V <sub>DS</sub> =0V, V <sub>GS</sub> =±8V			±10	μA
V <sub>GS(th)</sub>	Gate Threshold Voltage	V <sub>DS</sub> =V <sub>GS</sub> , I <sub>D</sub> =-250μA	-0.35	-0.53	-0.85	
I <sub>D(ON)</sub>	On state drain current	V <sub>GS</sub> =-4.5V, V <sub>DS</sub> =-5V	-60			A
R <sub>DS(ON)</sub>	Static Drain-Source On-Resistance	V <sub>GS</sub> =-4.5V, I <sub>D</sub> =-6.5A T <sub>J</sub> =125°C		16 23	20 28	mΩ
		V <sub>GS</sub> =-2.5V, I <sub>D</sub> =-6A		19	24	mΩ
		V <sub>GS</sub> =-1.8V, I <sub>D</sub> =-5.5A		23	30	mΩ
		V <sub>GS</sub> =-1.5V, I <sub>D</sub> =-5A		28	36	mΩ
g <sub>FS</sub>	Forward Transconductance	V <sub>DS</sub> =-5V, I <sub>D</sub> =-6.5A		45		S
V <sub>SD</sub>	Diode Forward Voltage	I <sub>S</sub> =-1A, V <sub>GS</sub> =0V		-0.56	-1	V
I <sub>S</sub>	Maximum Body-Diode Continuous Current				-1.4	A
<b>DYNAMIC PARAMETERS</b>						
C <sub>iss</sub>	Input Capacitance	V <sub>GS</sub> =0V, V <sub>DS</sub> =-6V, f=1MHz		1740	2100	pF
C <sub>oss</sub>	Output Capacitance			334		pF
C <sub>rss</sub>	Reverse Transfer Capacitance			200		pF
R <sub>g</sub>	Gate resistance	V <sub>GS</sub> =0V, V <sub>DS</sub> =0V, f=1MHz		1.3	1.7	kΩ
<b>SWITCHING PARAMETERS</b>						
Q <sub>g</sub>	Total Gate Charge	V <sub>GS</sub> =-4.5V, V <sub>DS</sub> =-6V, I <sub>D</sub> =-6.5A		19	23	nC
Q <sub>gs</sub>	Gate Source Charge			4.5		nC
Q <sub>gd</sub>	Gate Drain Charge			5.3		nC
t <sub>D(on)</sub>	Turn-On Delay Time	V <sub>GS</sub> =-4.5V, V <sub>DS</sub> =-6V, R <sub>L</sub> =0.9Ω, R <sub>GEN</sub> =3Ω		240		ns
t <sub>r</sub>	Turn-On Rise Time			580		ns
t <sub>D(off)</sub>	Turn-Off Delay Time			7		μs
t <sub>f</sub>	Turn-Off Fall Time			4.2		μs
t <sub>rr</sub>	Body Diode Reverse Recovery Time	I <sub>F</sub> =-6.5A, dI/dt=100A/μs		22	27	ns
Q <sub>rr</sub>	Body Diode Reverse Recovery Charge	I <sub>F</sub> =-6.5A, dI/dt=100A/μs		17		nC

A: The value of R<sub>θJA</sub> is measured with the device mounted on 1in<sup>2</sup> FR-4 board with 2oz. Copper, in a still air environment with T<sub>A</sub>=25°C. The value in any given application depends on the user's specific board design.

B: The power dissipation P<sub>D</sub> is based on T<sub>J(MAX)</sub>=150°C, using ≤ 10s junction-to-ambient thermal resistance.

C: Repetitive rating, pulse width limited by junction temperature T<sub>J(MAX)</sub>=150°C. Ratings are based on low frequency and duty cycles to keep initial T<sub>J</sub>=25°C.

D: The R<sub>θJA</sub> is the sum of the thermal impedance from junction to lead R<sub>θJL</sub> and lead to ambient.

E: The static characteristics in Figures 1 to 6 are obtained using <300 μs pulses, duty cycle 0.5% max.

F: These curves are based on the junction-to-ambient thermal impedance which is measured with the device mounted on 1in<sup>2</sup> FR-4 board with 2oz. Copper, assuming a maximum junction temperature of T<sub>J(MAX)</sub>=150°C. The SOA curve provides a single pulse rating.

Rev0 : July 2008

COMPONENTS IN LIFE SUPPORT DEVICES OR SYSTEMS ARE NOT AUTHORIZED. AOS DOES NOT ASSUME ANY LIABILITY ARISING OUT OF SUCH APPLICATIONS OR USES OF ITS PRODUCTS. AOS RESERVES THE RIGHT TO IMPROVE PRODUCT DESIGN, FUNCTIONS AND RELIABILITY WITHOUT NOTICE.

TYPICAL ELECTRICAL AND THERMAL CHARACTERISTICS

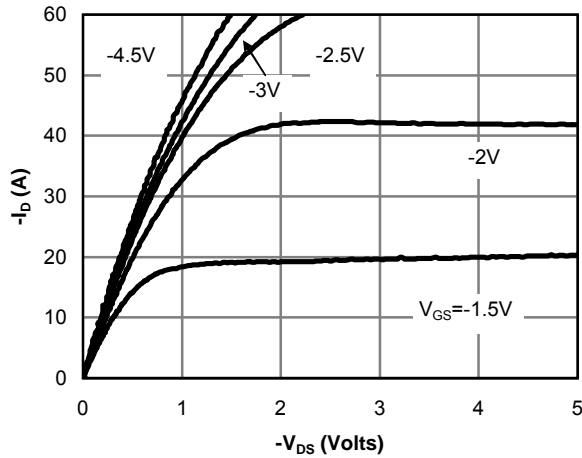

Figure 1: On-Region Characteristics(Note E)

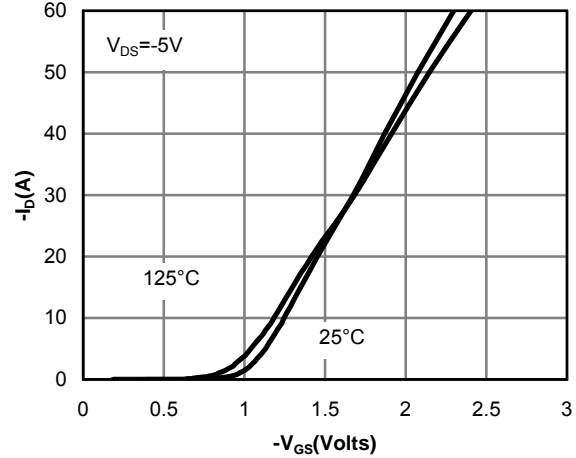

Figure 2: Transfer Characteristics(Note E)

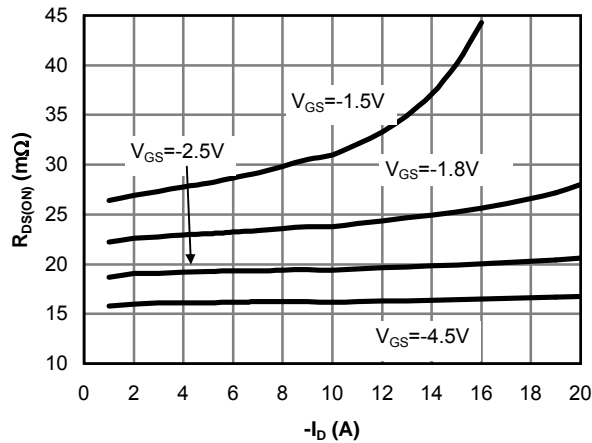

Figure 3: On-Resistance vs. Drain Current and Gate Voltage(Note E)

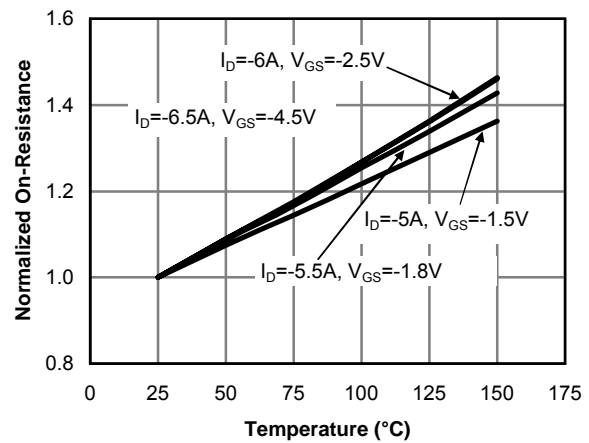

Figure 4: On-Resistance vs. Junction Temperature(Note E)

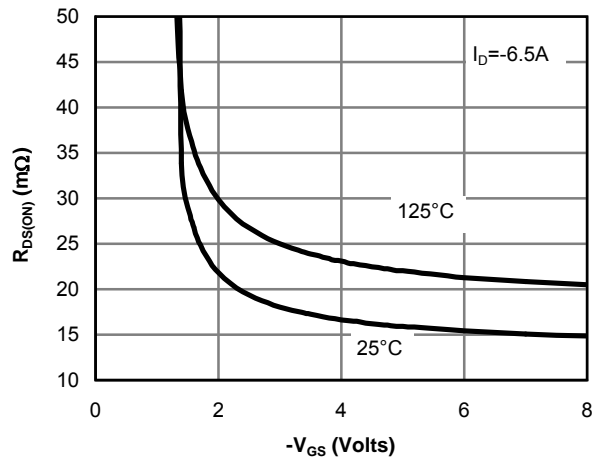

Figure 5: On-Resistance vs. Gate-Source Voltage(Note E)

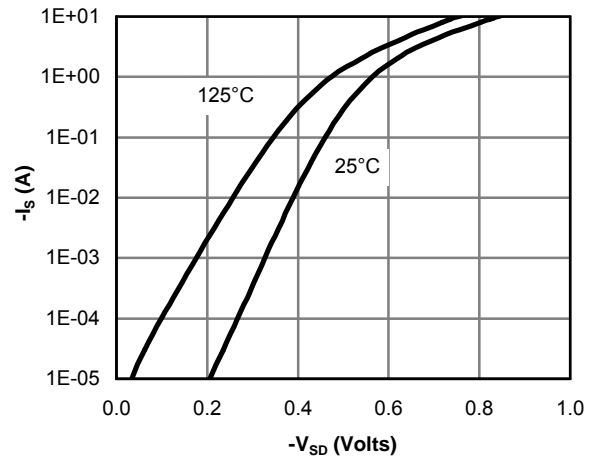

Figure 6: Body-Diode Characteristics(Note E)

TYPICAL ELECTRICAL AND THERMAL CHARACTERISTICS

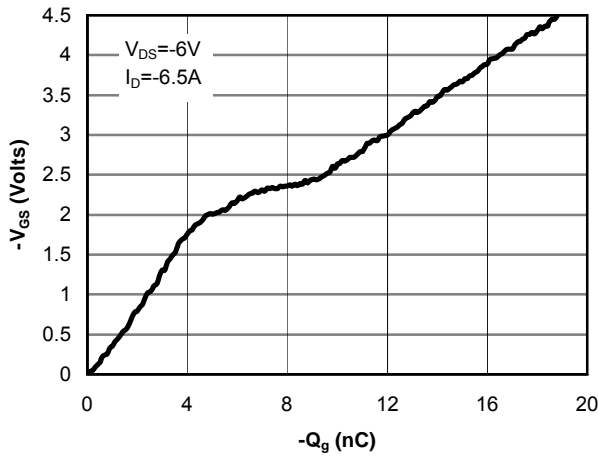

Figure 7: Gate-Charge Characteristics

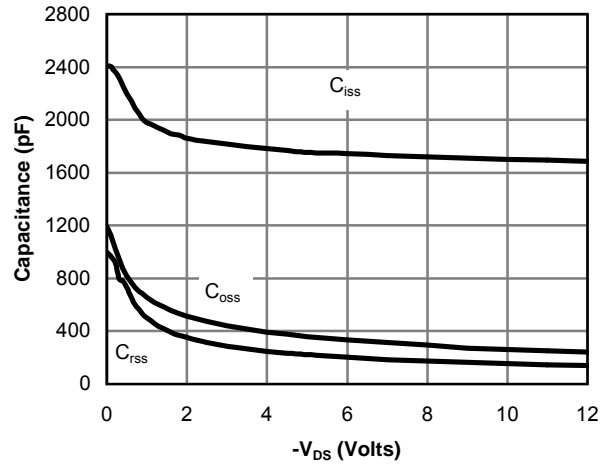

Figure 8: Capacitance Characteristics

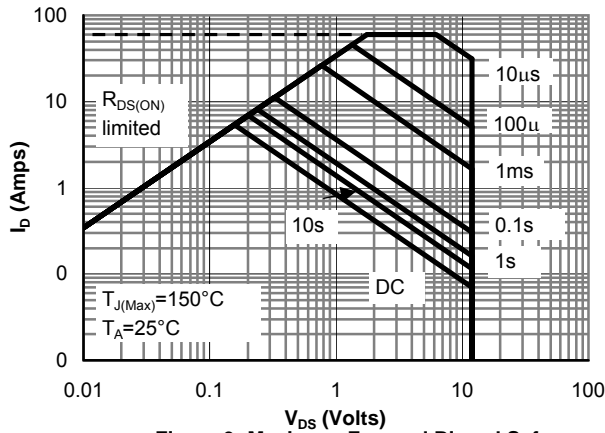

Figure 9: Maximum Forward Biased Safe Operating Area (Note F)

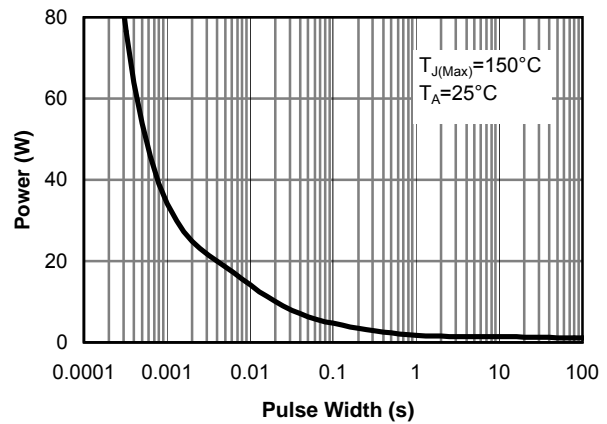

Figure 10: Single Pulse Power Rating Junction-to-Ambient (Note F)

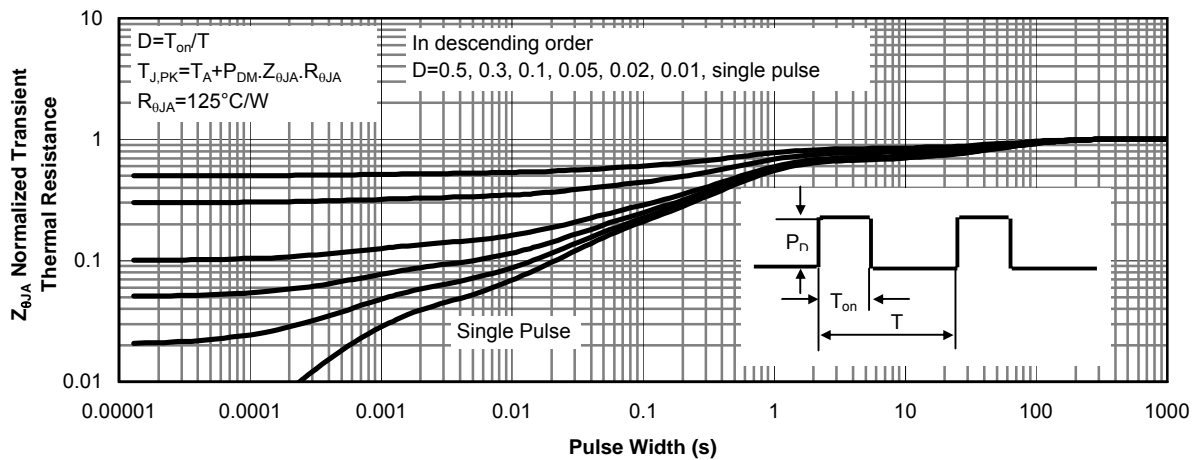
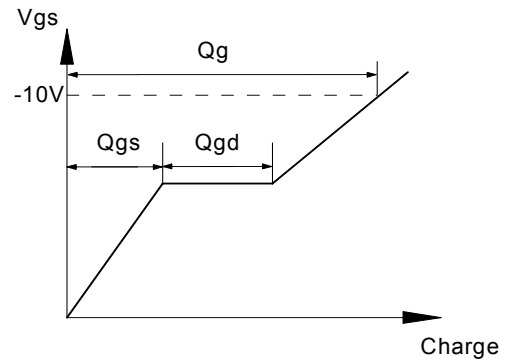
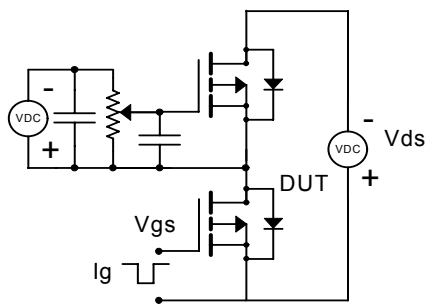
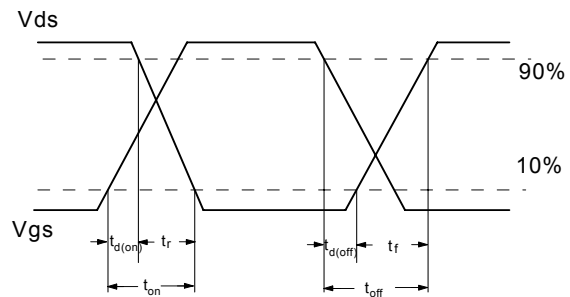
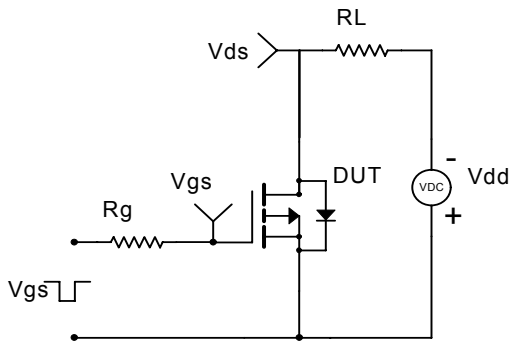

Figure 11: Normalized Maximum Transient Thermal Impedance (Note F)

Gate Charge Test Circuit & Waveform



Resistive Switching Test Circuit & Waveforms



Diode Recovery Test Circuit & Waveforms

