



AO4924

Asymmetric Dual N-Channel Enhancement Mode Field Effect Transistor

SRFET™

General Description

The AO4924 uses advanced trench technology to provide excellent $R_{DS(ON)}$ and low gate charge. The two MOSFETs make a compact and efficient switch and synchronous rectifier combination for use in DC-DC converters. A monolithically integrated Schottky diode in parallel with the synchronous MOSFET to boost efficiency further. *Standard Product AO4924 is Pb-free (meets ROHS & Sony 259 specifications). AO4924L is a Green Product ordering option. AO4924L and AO4924 are electrically identical.*

Features

FET1

V_{DS} (V) = 30V
 I_D = 9A
 $R_{DS(ON)}$ < 15.8m Ω
 $R_{DS(ON)}$ < 19.5m Ω

FET2

V_{DS} (V) = 30V
 I_D =7.3A (V_{GS} = 10V)
<24m Ω (V_{GS} = 10V)
<29m Ω (V_{GS} = 4.5V)

UIS TESTED!
Rg,Ciss,Coss,Crss Tested

SOIC-8

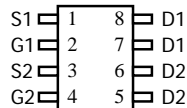

SRFET™

Soft Recovery MOSFET:
Integrated Schottky Diode

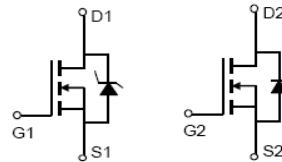

Absolute Maximum Ratings $T_A=25^\circ\text{C}$ unless otherwise noted

Parameter	Symbol	Max FET1	Max FET2	Units
Drain-Source Voltage	V_{DS}	30	30	V
Gate-Source Voltage	V_{GS}	± 12	± 12	V
Continuous Drain Current ^A	I_{DSM}	$T_A=25^\circ\text{C}$	9.0	A
		$T_A=70^\circ\text{C}$	7.2	
Pulsed Drain Current ^B	I_{DM}	40	40	
Avalanche Current ^B	I_{AR}	16	12	A
Repetitive avalanche energy $L=0.3\text{mH}^B$	E_{AR}	38	22	mJ
Power Dissipation	P_{DSM}	$T_A=25^\circ\text{C}$	2.0	W
		$T_A=70^\circ\text{C}$	1.3	
Junction and Storage Temperature Range	T_J, T_{STG}	-55 to 150	-55 to 150	$^\circ\text{C}$

Thermal Characteristics FET1

Parameter	Symbol	Typ	Max	Units
Maximum Junction-to-Ambient ^A	$R_{\theta JA}$	48	62.5	$^\circ\text{C/W}$
Maximum Junction-to-Ambient ^A		Steady-State	74	90
Maximum Junction-to-Lead ^C	$R_{\theta JL}$	32	40	$^\circ\text{C/W}$

Thermal Characteristics FET2

Parameter	Symbol	Typ	Max	Units
Maximum Junction-to-Ambient ^A	$R_{\theta JA}$	48	62.5	$^\circ\text{C/W}$
Maximum Junction-to-Ambient ^A		Steady-State	74	90
Maximum Junction-to-Lead ^C	$R_{\theta JL}$	32	40	$^\circ\text{C/W}$

FET1 Electrical Characteristics ($T_J=25^\circ\text{C}$ unless otherwise noted)

Symbol	Parameter	Conditions	Min	Typ	Max	Units
STATIC PARAMETERS						
BV_{DSS}	Drain-Source Breakdown Voltage	$I_D=1\text{mA}, V_{GS}=0\text{V}$	30			V
I_{DSS}	Zero Gate Voltage Drain Current	$V_{DS}=24\text{V}, V_{GS}=0\text{V}$ $T_J=125^\circ\text{C}$		0.01 5	0.1 10	mA
I_{GSS}	Gate-Body leakage current	$V_{DS}=0\text{V}, V_{GS}=\pm 12\text{V}$			0.1	μA
$V_{GS(th)}$	Gate Threshold Voltage	$V_{DS}=V_{GS}, I_D=250\mu\text{A}$	1.5	1.85	2.4	V
$I_{D(ON)}$	On state drain current	$V_{GS}=4.5\text{V}, V_{DS}=5\text{V}$	40			A
$R_{DS(ON)}$	Static Drain-Source On-Resistance	$V_{GS}=10\text{V}, I_D=9\text{A}$ $T_J=125^\circ\text{C}$		13 20.0	15.8 25.0	m Ω
		$V_{GS}=4.5\text{V}, I_D=7\text{A}$		15.7	19.5	m Ω
g_{FS}	Forward Transconductance	$V_{DS}=5\text{V}, I_D=9\text{A}$		64		S
V_{SD}	Diode Forward Voltage	$I_S=1\text{A}, V_{GS}=0\text{V}$		0.4	0.6	V
I_S	Maximum Body-Diode + Schottky Continuous Current				4.5	A
DYNAMIC PARAMETERS						
C_{iss}	Input Capacitance	$V_{GS}=0\text{V}, V_{DS}=15\text{V}, f=1\text{MHz}$		1450	1885	pF
C_{oss}	Output Capacitance			224		pF
C_{riss}	Reverse Transfer Capacitance			92		pF
R_g	Gate resistance	$V_{GS}=0\text{V}, V_{DS}=0\text{V}, f=1\text{MHz}$		1.6	3	Ω
SWITCHING PARAMETERS						
$Q_g(10\text{V})$	Total Gate Charge	$V_{GS}=10\text{V}, V_{DS}=15\text{V}, I_D=9\text{A}$		24.0	31	
$Q_g(4.5\text{V})$	Total Gate Charge			12.0		nC
Q_{gs}	Gate Source Charge			3.9		nC
Q_{gd}	Gate Drain Charge			4.2		nC
$t_{D(on)}$	Turn-On Delay Time	$V_{GS}=10\text{V}, V_{DS}=15\text{V}, R_L=1.7\Omega,$ $R_{GEN}=3\Omega$		5.5		ns
t_r	Turn-On Rise Time			4.7		ns
$t_{D(off)}$	Turn-Off Delay Time			24.0		ns
t_f	Turn-Off Fall Time			4.0		ns
t_{rr}	Body Diode Reverse Recovery Time	$I_F=9\text{A}, dI/dt=300\text{A}/\mu\text{s}$		10	13	ns
Q_{rr}	Body Diode Reverse Recovery Charge	$I_F=9\text{A}, dI/dt=300\text{A}/\mu\text{s}$		6.8		nC

A: The value of $R_{\theta JA}$ is measured with the device in a still air environment with $T_A=25^\circ\text{C}$. The power dissipation P_{DSM} and current rating I_{DSM} are based on $T_{J(MAX)}=150^\circ\text{C}$, using $t \leq 10\text{s}$ junction-to-ambient thermal resistance.

B: Repetitive rating, pulse width limited by junction temperature $T_{J(MAX)}=150^\circ\text{C}$.

C: The $R_{\theta JA}$ is the sum of the thermal impedance from junction to lead $R_{\theta JL}$ and lead to ambient.

D: The static characteristics in Figures 1 to 6 are obtained using $<300\mu\text{s}$ pulses, duty cycle 0.5% max.

E: These tests are performed with the device mounted on 1 in 2 FR-4 board with 2oz. Copper, in a still air environment with $T_A=25^\circ\text{C}$. The SOA curve provides a single pulse rating.

Rev1: July, 2008

THIS PRODUCT HAS BEEN DESIGNED AND QUALIFIED FOR THE CONSUMER MARKET. APPLICATIONS OR USES AS CRITICAL COMPONENTS IN LIFE SUPPORT DEVICES OR SYSTEMS ARE NOT AUTHORIZED. AOS DOES NOT ASSUME ANY LIABILITY ARISING OUT OF SUCH APPLICATIONS OR USES OF ITS PRODUCTS. AOS RESERVES THE RIGHT TO IMPROVE PRODUCT DESIGN, FUNCTIONS AND RELIABILITY WITHOUT NOTICE.

FET1 TYPICAL ELECTRICAL AND THERMAL CHARACTERISTICS

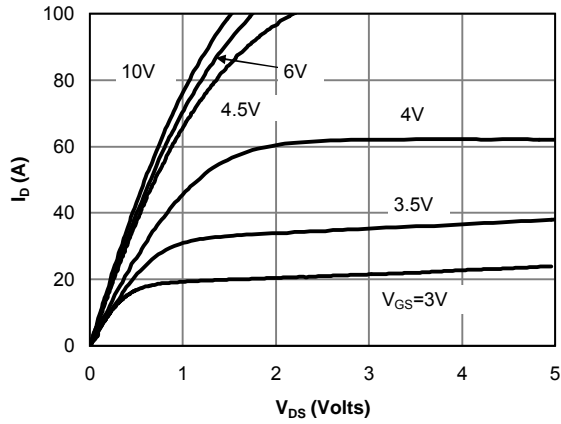

Figure 1: On-Region Characteristics

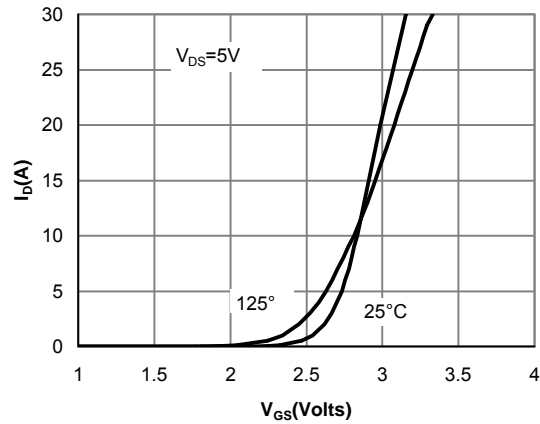

Figure 2: Transfer Characteristics

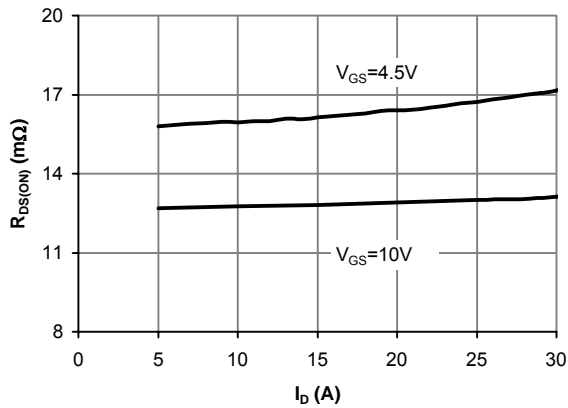

Figure 3: On-Resistance vs. Drain Current and Gate Voltage

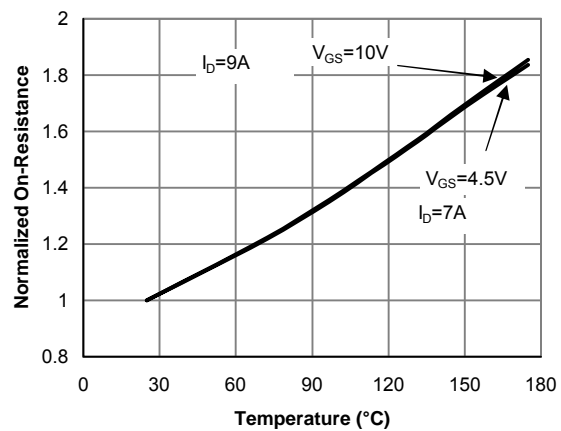

Figure 4: On-Resistance vs. Junction Temperature

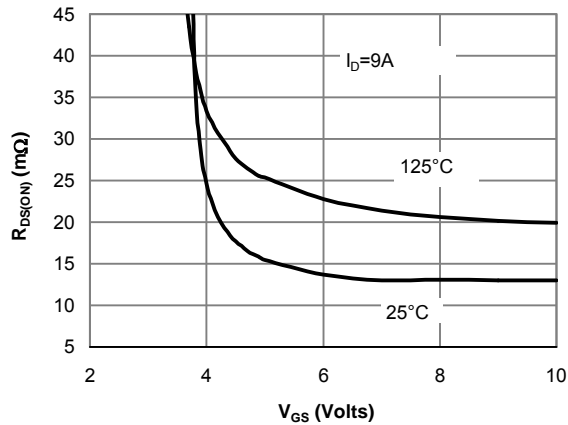

Figure 5: On-Resistance vs. Gate-Source Voltage

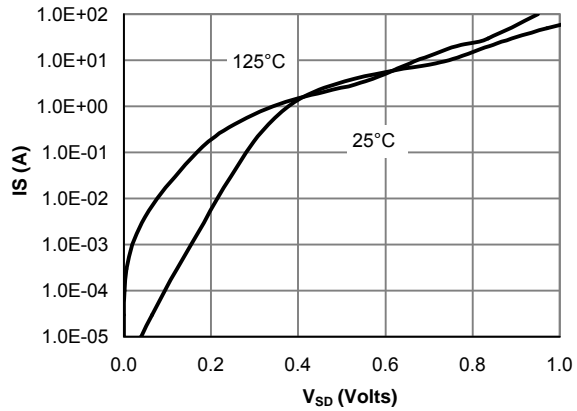

Figure 6: Body-Diode Characteristics

FET1 TYPICAL ELECTRICAL AND THERMAL CHARACTERISTICS

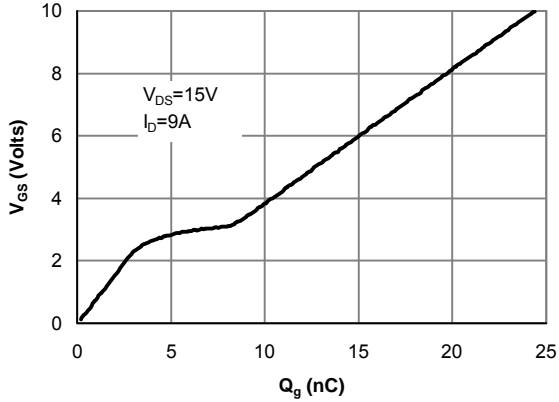

Figure 7: Gate-Charge Characteristics

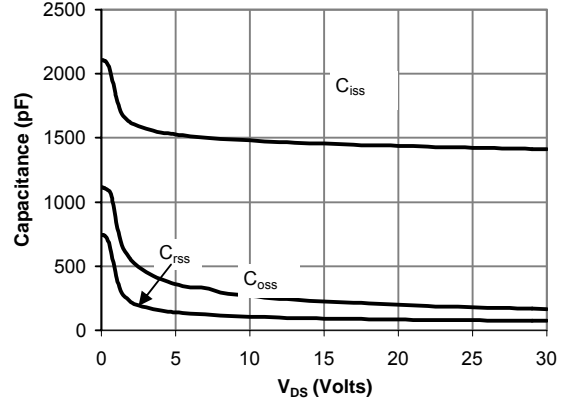

Figure 8: Capacitance Characteristics

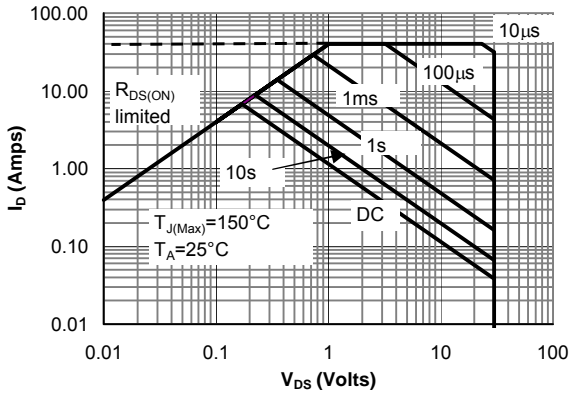

Figure 9: Maximum Forward Biased Safe Operating Area (Note E)

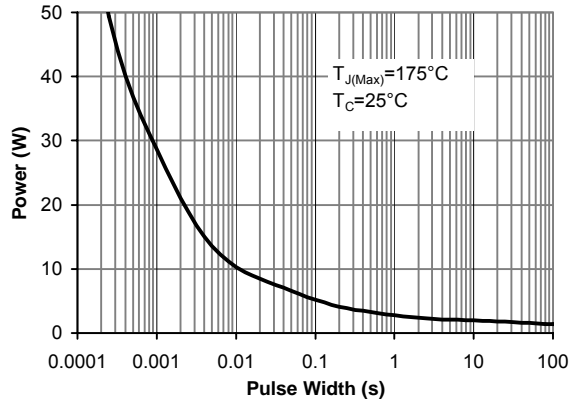

Figure 10: Single Pulse Power Rating Junction-to-Ambient (Note E)

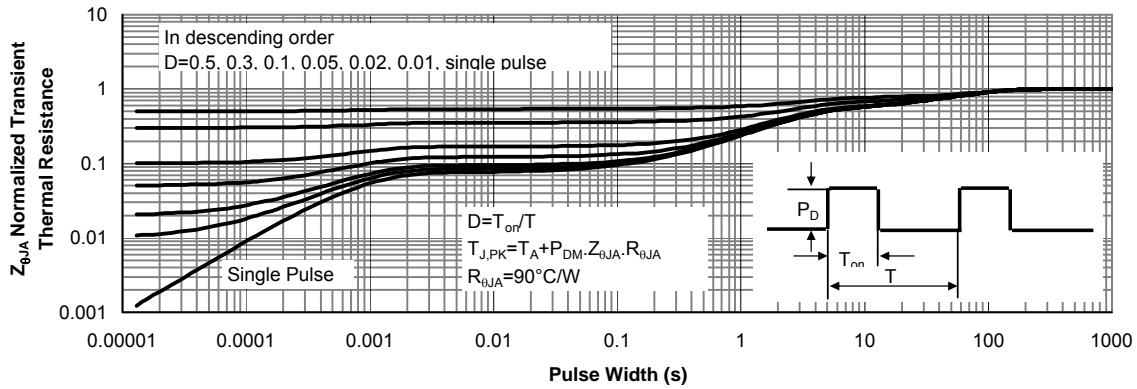

Figure 11: Normalized Maximum Transient Thermal Impedance (Note E)

FET1 TYPICAL ELECTRICAL AND THERMAL CHARACTERISTICS

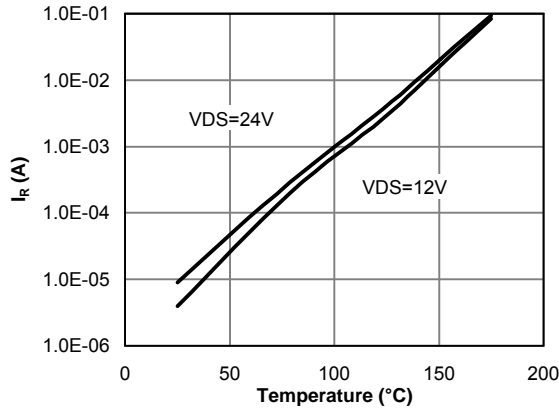

Figure 12: Diode Reverse Leakage Current vs. Junction Temperature

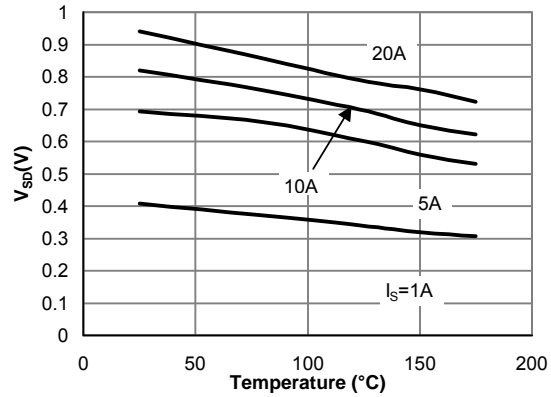

Figure 13: Diode Forward voltage vs. Junction Temperature

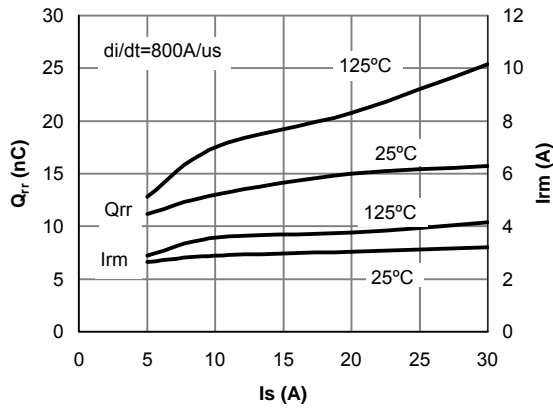

Figure 14: Diode Reverse Recovery Charge and Peak Current vs. Conduction Current

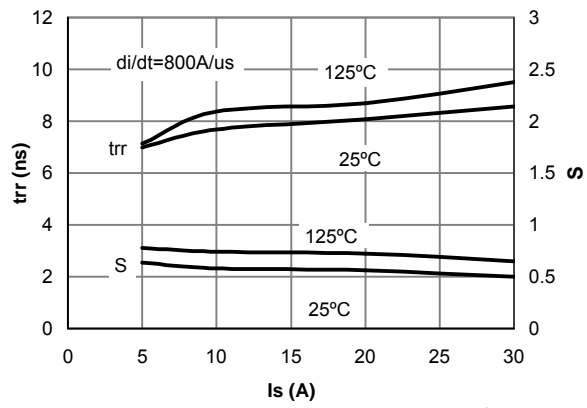

Figure 15: Diode Reverse Recovery Time and Soft Coefficient vs. Conduction Current

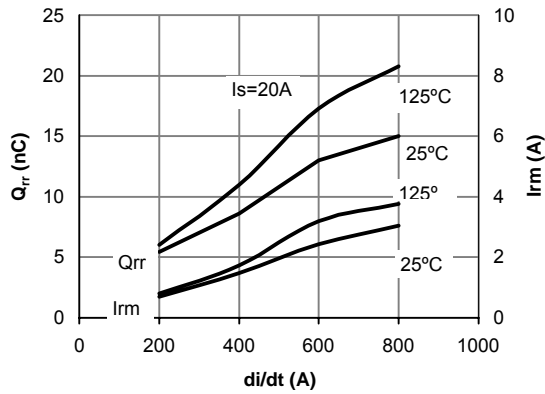

Figure 16: Diode Reverse Recovery Charge and Peak Current vs. di/dt

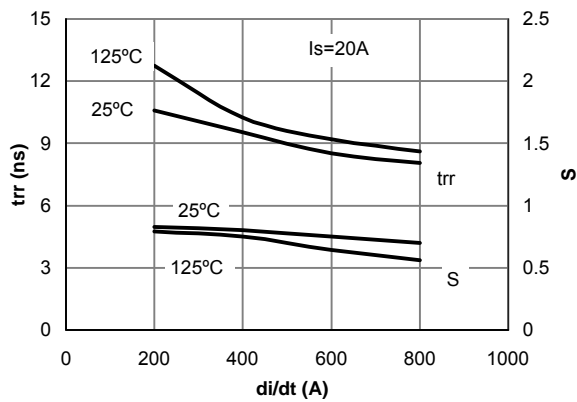

Figure 17: Diode Reverse Recovery Time and Soft Coefficient vs. di/dt

FET2 Electrical Characteristics ($T_J=25^\circ\text{C}$ unless otherwise noted)

Symbol	Parameter	Conditions	Min	Typ	Max	Units
STATIC PARAMETERS						
BV_{DSS}	Drain-Source Breakdown Voltage	$I_D=250\mu\text{A}$, $V_{GS}=0\text{V}$	30			V
I_{DSS}	Zero Gate Voltage Drain Current	$V_{DS}=24\text{V}$, $V_{GS}=0\text{V}$ $T_J=55^\circ\text{C}$			1	μA
					5	
I_{GSS}	Gate-Body leakage current	$V_{DS}=0\text{V}$, $V_{GS}=\pm 12\text{V}$			100	nA
$V_{GS(th)}$	Gate Threshold Voltage	$V_{DS}=V_{GS}$, $I_D=250\mu\text{A}$	0.7	1	1.5	V
$I_{D(ON)}$	On state drain current	$V_{GS}=4.5\text{V}$, $V_{DS}=5\text{V}$	40			A
$R_{DS(ON)}$	Static Drain-Source On-Resistance	$V_{GS}=10\text{V}$, $I_D=7.3\text{A}$ $T_J=125^\circ\text{C}$		20	24	m Ω
				28	34	
		$V_{GS}=4.5\text{V}$, $I_D=6\text{A}$		23.5	29	m Ω
g_{FS}	Forward Transconductance	$V_{DS}=5\text{V}$, $I_D=7.3\text{A}$		26		S
V_{SD}	Diode Forward Voltage	$I_S=1\text{A}$, $V_{GS}=0\text{V}$		0.71	1	V
I_S	Maximum Body-Diode Continuous Current				4.5	A
DYNAMIC PARAMETERS						
C_{iss}	Input Capacitance	$V_{GS}=0\text{V}$, $V_{DS}=15\text{V}$, $f=1\text{MHz}$		900	1100	pF
C_{oss}	Output Capacitance			88		pF
C_{rss}	Reverse Transfer Capacitance			65		pF
R_g	Gate resistance	$V_{GS}=0\text{V}$, $V_{DS}=0\text{V}$, $f=1\text{MHz}$		0.95	1.5	Ω
SWITCHING PARAMETERS						
Q_g	Total Gate Charge	$V_{GS}=4.5\text{V}$, $V_{DS}=15\text{V}$, $I_D=7.3\text{A}$		10	12	nC
Q_{gs}	Gate Source Charge			1.8		nC
Q_{gd}	Gate Drain Charge			3.75		nC
$t_{D(on)}$	Turn-On Delay Time	$V_{GS}=10\text{V}$, $V_{DS}=15\text{V}$, $R_L=2\Omega$, $R_{GEN}=6\Omega$		3.2		ns
t_r	Turn-On Rise Time			3.5		ns
$t_{D(off)}$	Turn-Off Delay Time			21.5		ns
t_f	Turn-Off Fall Time			2.7		ns
t_{rr}	Body Diode Reverse Recovery Time	$I_F=7.3\text{A}$, $di/dt=100\text{A}/\mu\text{s}$		16.8	20	ns
Q_{rr}	Body Diode Reverse Recovery Charge	$I_F=7.3\text{A}$, $di/dt=100\text{A}/\mu\text{s}$		8	12	nC

A: The value of $R_{\theta JA}$ is measured with the device mounted on 1in² FR-4 board with 2oz. Copper, in a still air environment with $T_A=25^\circ\text{C}$. The value in any given application depends on the user's specific board design. The current rating is based on the $t \leq 10\text{s}$ thermal resistance rating.

B: Repetitive rating, pulse width limited by junction temperature.

C: The $R_{\theta JA}$ is the sum of the thermal impedance from junction to lead $R_{\theta JL}$ and lead to ambient.

D: The static characteristics in Figures 1 to 6 are obtained using $<300\mu\text{s}$ pulses, duty cycle 0.5% max.

E: These tests are performed with the device mounted on 1 in² FR-4 board with 2oz. Copper, in a still air environment with $T_A=25^\circ\text{C}$. The SOA curve provides a single pulse rating.

Rev 0 : Sept. 2006

THIS PRODUCT HAS BEEN DESIGNED AND QUALIFIED FOR THE CONSUMER MARKET. APPLICATIONS OR USES AS CRITICAL COMPONENTS IN LIFE SUPPORT DEVICES OR SYSTEMS ARE NOT AUTHORIZED. AOS DOES NOT ASSUME ANY LIABILITY ARISING OUT OF SUCH APPLICATIONS OR USES OF ITS PRODUCTS. AOS RESERVES THE RIGHT TO IMPROVE PRODUCT DESIGN, FUNCTIONS AND RELIABILITY WITHOUT NOTICE.

FET2 TYPICAL ELECTRICAL AND THERMAL CHARACTERISTICS

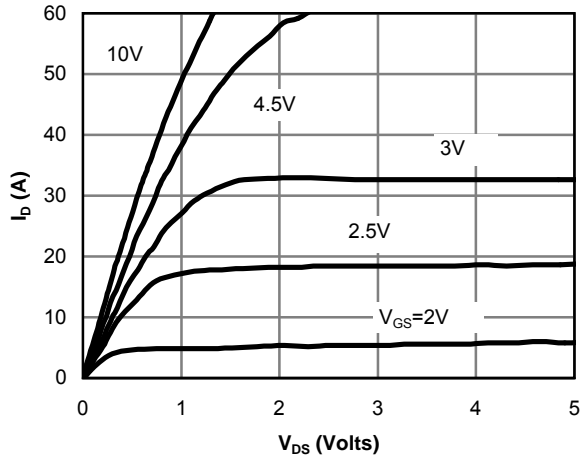

Fig 1: On-Region Characteristics

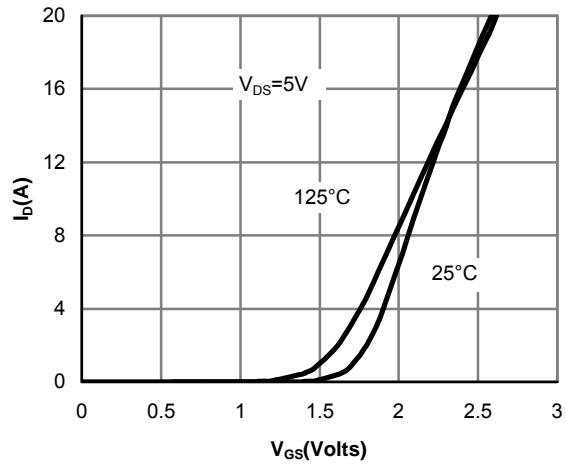

Figure 2: Transfer Characteristics

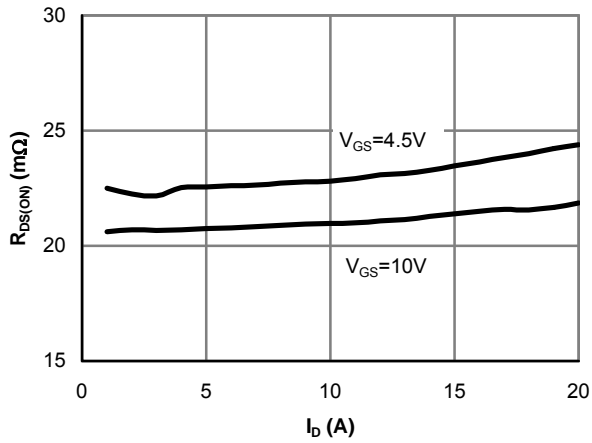

Figure 3: On-Resistance vs. Drain Current and Gate Voltage

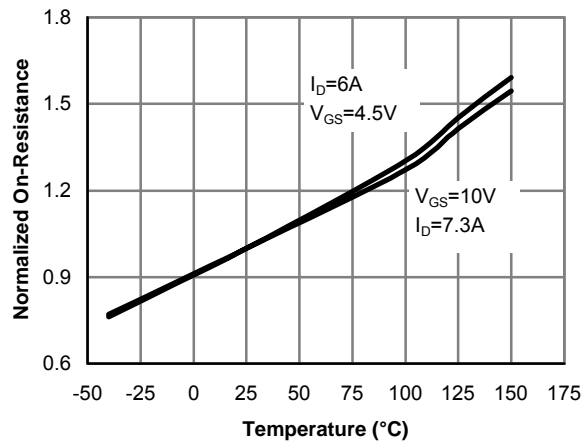

Figure 4: On-Resistance vs. Junction Temperature

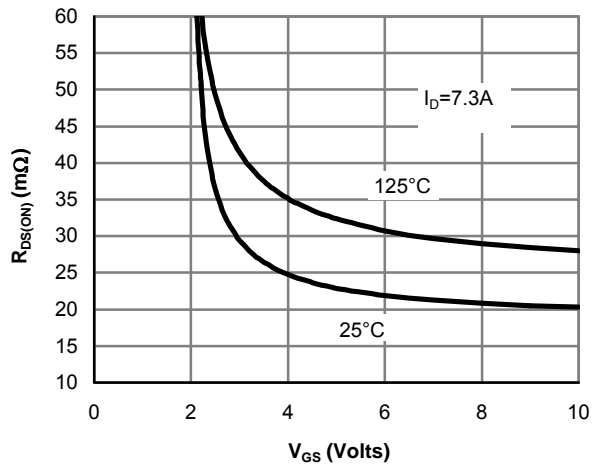

Figure 5: On-Resistance vs. Gate-Source Voltage

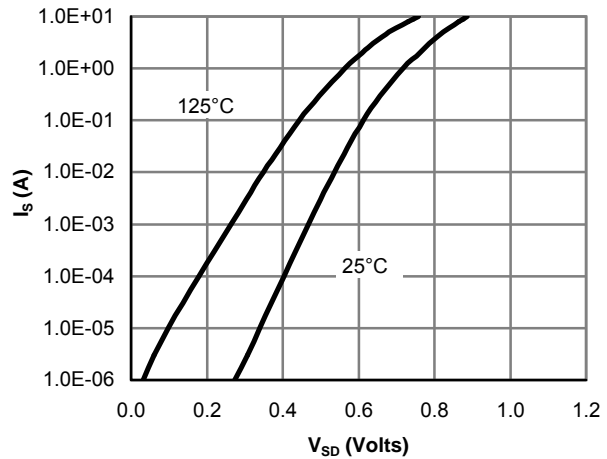

Figure 6: Body-Diode Characteristics

FET2 TYPICAL ELECTRICAL AND THERMAL CHARACTERISTICS

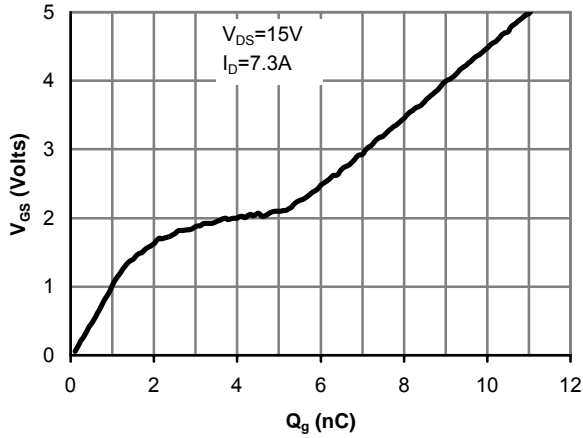

Figure 7: Gate-Charge Characteristics

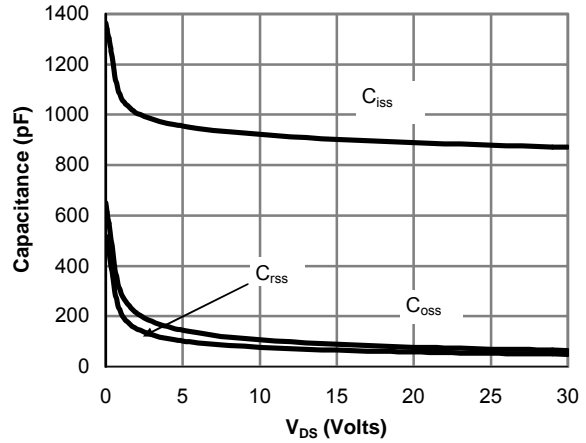

Figure 8: Capacitance Characteristics

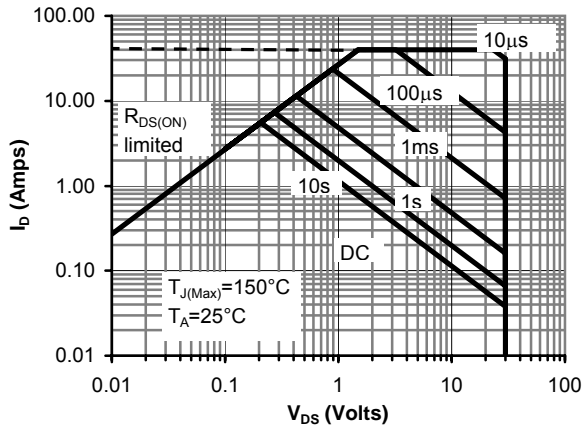

Figure 9: Maximum Forward Biased Safe Operating Area (Note E)

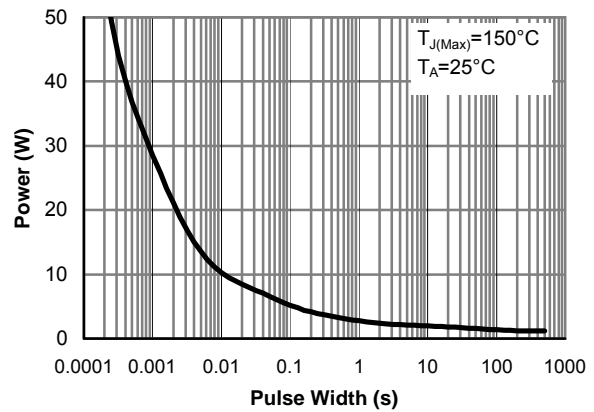

Figure 10: Single Pulse Power Rating Junction-to-Ambient (Note E)

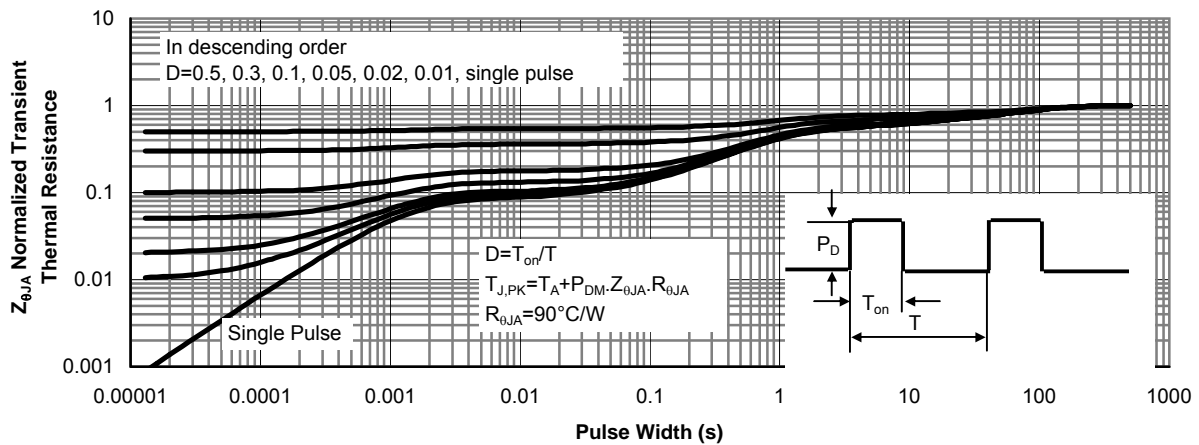
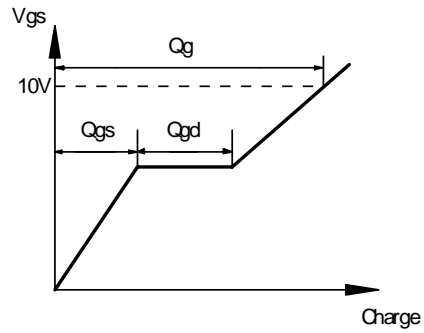
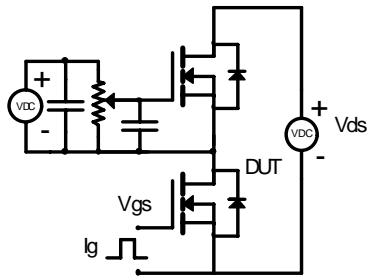
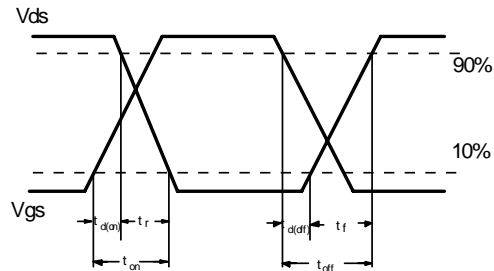
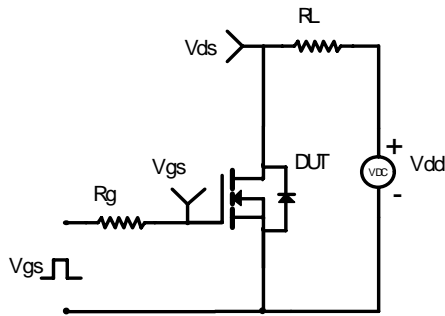

Figure 11: Normalized Maximum Transient Thermal Impedance

Gate Charge Test Circuit & Waveform



Resistive Switching Test Circuit & Waveforms



Unclamped Inductive Switching (UIS) Test Circuit & Waveforms

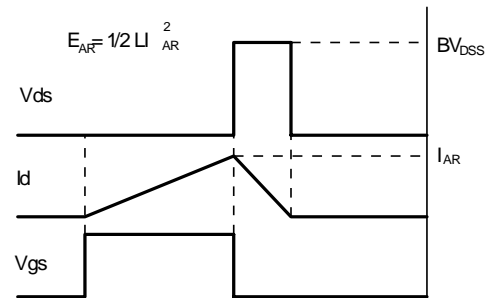
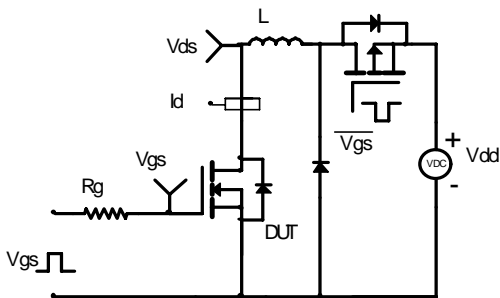

Diode Recovery Test Circuit & Waveforms

