



AO4710

N-Channel Enhancement Mode Field Effect Transistor

SRFET™



General Description

SRFET™ The AO4710/L uses advanced trench technology with a monolithically integrated Schottky diode to provide excellent $R_{DS(ON)}$, and low gate charge. This device is suitable for use as a low side FET in SMPS, load switching and general purpose applications. *AO4710 and AO4710L are electrically identical.*

- RoHS Compliant
- AO4710L is Halogen Free

Features

- $V_{DS} (V) = 30V$
- $I_D = 12.7A (V_{GS} = 10V)$
- $R_{DS(ON)} < 11.8m\Omega (V_{GS} = 10V)$
- $R_{DS(ON)} < 14.2m\Omega (V_{GS} = 4.5V)$

UIS TESTED!
Rg,Ciss,Coss,Crss Tested

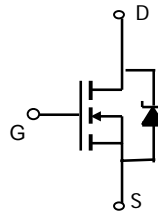
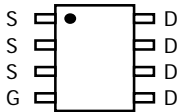

SRFET™
Soft Recovery MOSFET:
Integrated Schottky Diode

Absolute Maximum Ratings $T_A=25^\circ C$ unless otherwise noted

Parameter	Symbol	Maximum	Units
Drain-Source Voltage	V_{DS}	30	V
Gate-Source Voltage	V_{GS}	± 12	V
Continuous Drain Current ^{AF}	I_{DSM}	$T_A=25^\circ C$	12.7
		$T_A=70^\circ C$	10
Pulsed Drain Current ^B	I_{DM}	60	A
Avalanche Current ^C	I_{AR}	22	A
Repetitive avalanche energy $L=0.3mH$ ^C	E_{AR}	73	mJ
Power Dissipation	P_{DSM}	$T_A=25^\circ C$	3.1
		$T_A=70^\circ C$	2.0
Junction and Storage Temperature Range	T_J, T_{STG}	-55 to 150	$^\circ C$

Thermal Characteristics

Parameter	Symbol	Typ	Max	Units
Maximum Junction-to-Ambient ^A	$R_{\theta JA}$	$t \leq 10s$	32	$^\circ C/W$
Maximum Junction-to-Ambient ^A		Steady-State	60	$^\circ C/W$
Maximum Junction-to-Lead ^C	$R_{\theta JL}$	17	24	$^\circ C/W$

Electrical Characteristics ($T_J=25^\circ\text{C}$ unless otherwise noted)

Symbol	Parameter	Conditions	Min	Typ	Max	Units
STATIC PARAMETERS						
BV_{DSS}	Drain-Source Breakdown Voltage	$I_D=1\text{mA}, V_{GS}=0\text{V}$	30			V
I_{DSS}	Zero Gate Voltage Drain Current	$V_{DS}=30\text{V}, V_{GS}=0\text{V}$ $T_J=125^\circ\text{C}$		0.02 6	0.1 20	mA
I_{GSS}	Gate-Body leakage current	$V_{DS}=0\text{V}, V_{GS}=\pm 12\text{V}$			0.1	μA
$V_{GS(th)}$	Gate Threshold Voltage	$V_{DS}=V_{GS}, I_D=250\mu\text{A}$	1.5	1.9	2.3	V
$I_{D(ON)}$	On state drain current	$V_{GS}=10\text{V}, V_{DS}=5\text{V}$	60			A
$R_{DS(ON)}$	Static Drain-Source On-Resistance	$V_{GS}=10\text{V}, I_D=12.7\text{A}$ $T_J=125^\circ\text{C}$		9.8 15.2	11.8 19.0	$\text{m}\Omega$
		$V_{GS}=4.5\text{V}, I_D=11\text{A}$		11.7	14.2	$\text{m}\Omega$
g_{FS}	Forward Transconductance	$V_{DS}=5\text{V}, I_D=12.7\text{A}$		78		S
V_{SD}	Diode Forward Voltage	$I_S=1\text{A}, V_{GS}=0\text{V}$		0.38	0.5	V
I_S	Maximum Body-Diode + Schottky Continuous Current				5	A
DYNAMIC PARAMETERS						
C_{iss}	Input Capacitance	$V_{GS}=0\text{V}, V_{DS}=15\text{V}, f=1\text{MHz}$		1980	2376	pF
C_{oss}	Output Capacitance			317		pF
C_{rss}	Reverse Transfer Capacitance			111		pF
R_g	Gate resistance	$V_{GS}=0\text{V}, V_{DS}=0\text{V}, f=1\text{MHz}$		1.3	2.0	Ω
SWITCHING PARAMETERS						
$Q_g(10\text{V})$	Total Gate Charge	$V_{GS}=10\text{V}, V_{DS}=15\text{V}, I_D=12.7\text{A}$		33	43	nC
$Q_g(4.5\text{V})$	Total Gate Charge			15.0	20	nC
Q_{gs}	Gate Source Charge			5.3		nC
Q_{gd}	Gate Drain Charge			6.0		nC
$t_{D(on)}$	Turn-On Delay Time	$V_{GS}=10\text{V}, V_{DS}=15\text{V}, R_L=1.2\Omega,$ $R_{GEN}=3\Omega$		5.5		ns
t_r	Turn-On Rise Time			5.5		ns
$t_{D(off)}$	Turn-Off Delay Time			27.0		ns
t_f	Turn-Off Fall Time			4.3		ns
t_{rr}	Body Diode Reverse Recovery Time		$I_F=12.7\text{A}, dI/dt=300\text{A}/\mu\text{s}$		11.2	13
Q_{rr}	Body Diode Reverse Recovery Charge	$I_F=12.7\text{A}, dI/dt=300\text{A}/\mu\text{s}$		7		nC

A: The value of $R_{\theta JA}$ is measured with the device mounted on a 1in^2 FR-4 board with 2oz. Copper, in a still air environment with $T_A=25^\circ\text{C}$. The value in any given application depends on the user's specific board design.

B: Repetitive rating, pulse width limited by junction temperature $T_{J(MAX)}=150^\circ\text{C}$.

C: The $R_{\theta JA}$ is the sum of the thermal impedance from junction to lead $R_{\theta JL}$ and lead to ambient.

D: The static characteristics in Figures 1 to 6 are obtained using $<300\mu\text{s}$ pulses, duty cycle 0.5% max.

E: These tests are performed with the device mounted on a 1in^2 FR-4 board with 2oz. Copper, in a still air environment with $T_A=25^\circ\text{C}$. The SOA curve provides a single pulse rating.

F: The current rating is based on the $t \leq 10\text{s}$ thermal resistance rating.

Rev3: July 2008

THIS PRODUCT HAS BEEN DESIGNED AND QUALIFIED FOR THE CONSUMER MARKET. APPLICATIONS OR USES AS CRITICAL COMPONENTS IN LIFE SUPPORT DEVICES OR SYSTEMS ARE NOT AUTHORIZED. AOS DOES NOT ASSUME ANY LIABILITY ARISING OUT OF SUCH APPLICATIONS OR USES OF ITS PRODUCTS. AOS RESERVES THE RIGHT TO IMPROVE PRODUCT DESIGN, FUNCTIONS AND RELIABILITY WITHOUT NOTICE.

TYPICAL ELECTRICAL AND THERMAL CHARACTERISTICS

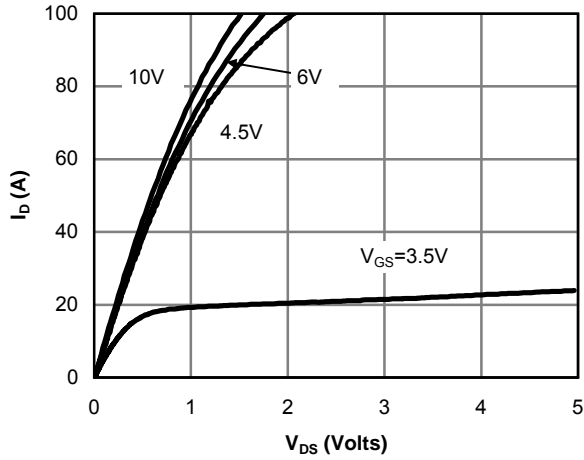

Figure 1: On-Region Characteristics

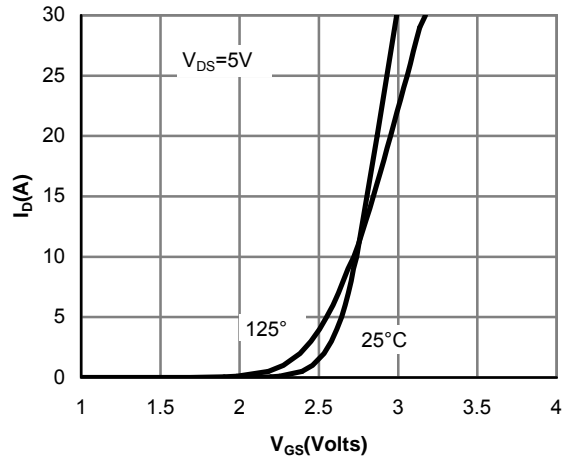

Figure 2: Transfer Characteristics

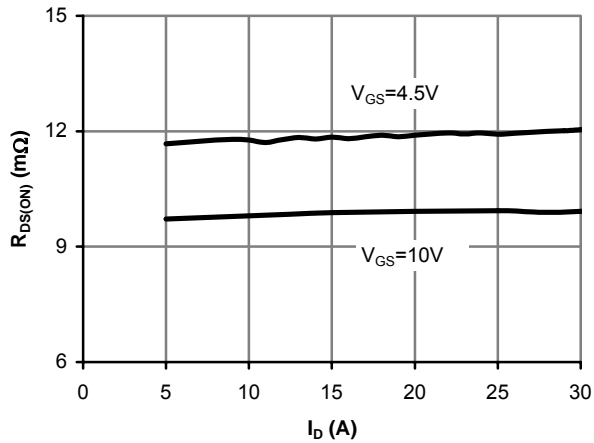

Figure 3: On-Resistance vs. Drain Current and Gate Voltage

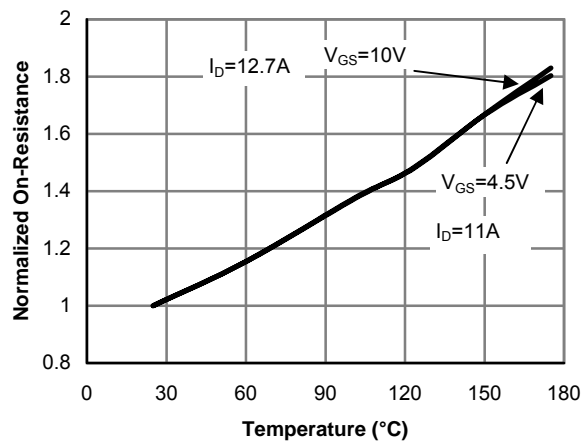

Figure 4: On-Resistance vs. Junction Temperature

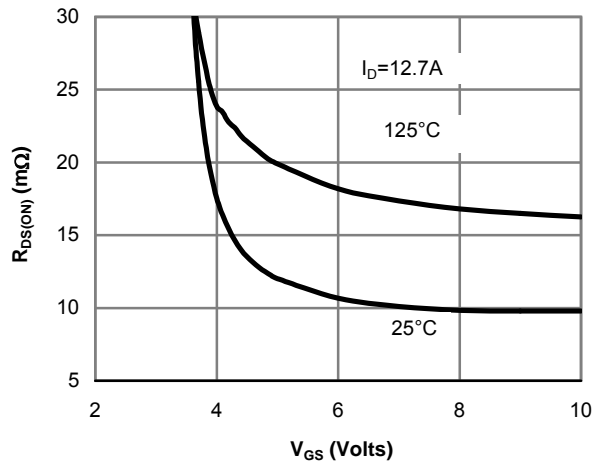

Figure 5: On-Resistance vs. Gate-Source Voltage

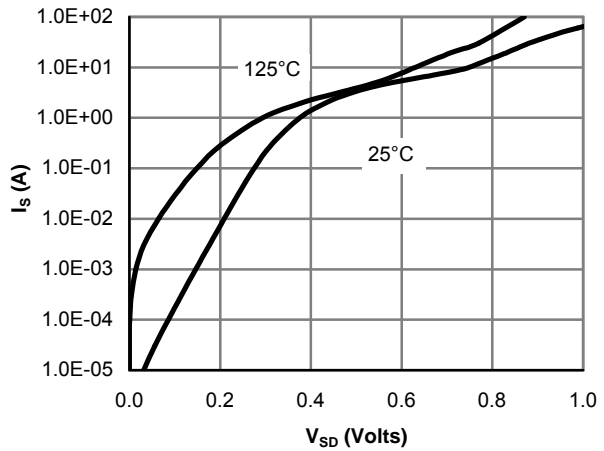

Figure 6: Body-Diode Characteristics

TYPICAL ELECTRICAL AND THERMAL CHARACTERISTICS

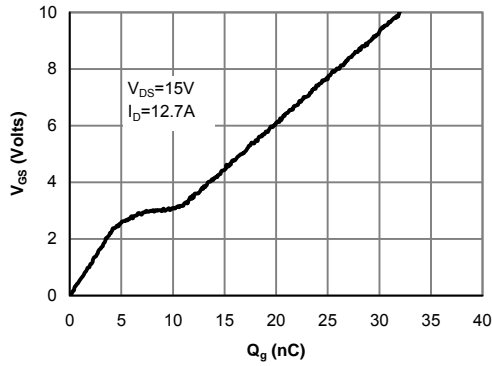

Figure 7: Gate-Charge Characteristics

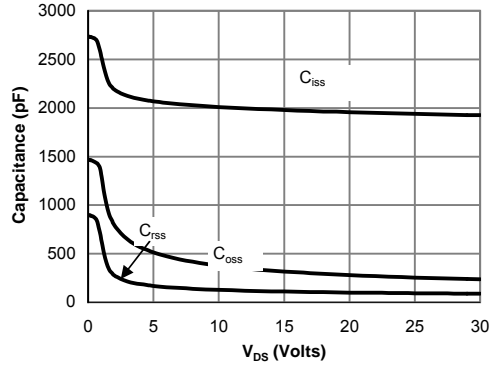

Figure 8: Capacitance Characteristics

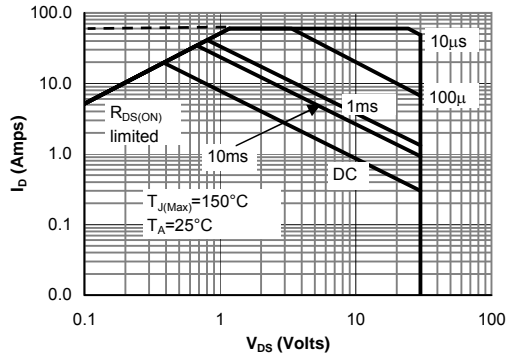

Figure 9: Maximum Forward Biased Safe Operating Area (Note E)

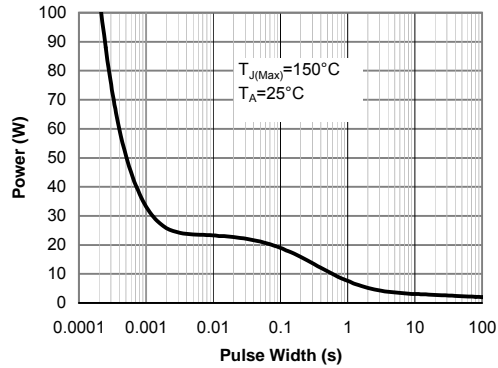

Figure 10: Single Pulse Power Rating Junction-to-Ambient (Note E)

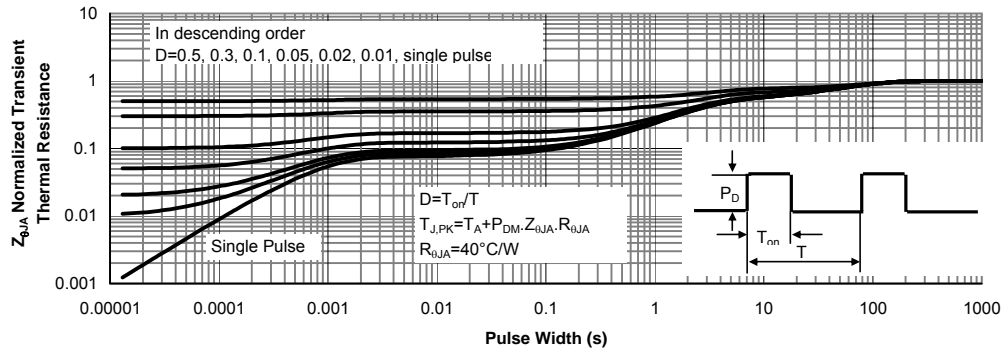

Figure 11: Normalized Maximum Transient Thermal Impedance (Note E)

TYPICAL ELECTRICAL AND THERMAL CHARACTERISTICS

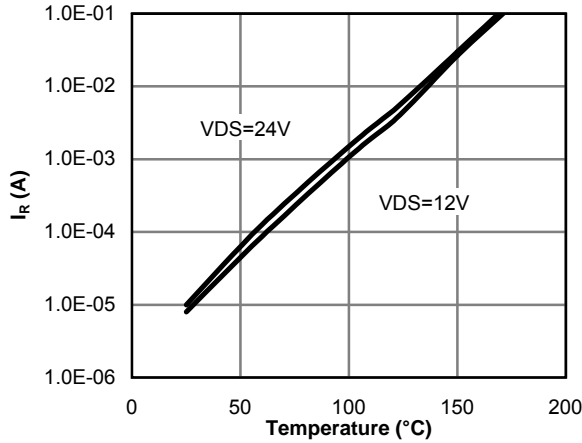

Figure 12: Diode Reverse Leakage Current vs. Junction Temperature

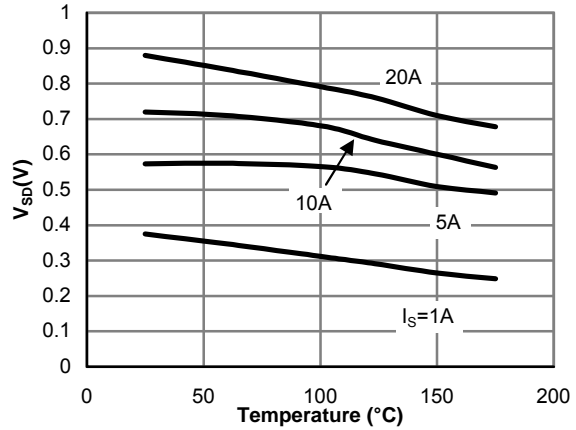

Figure 13: Diode Forward voltage vs. Junction Temperature

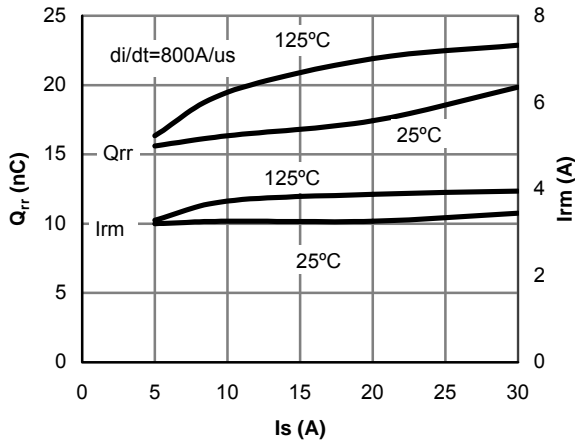

Figure 14: Diode Reverse Recovery Charge and Peak Current vs. Conduction Current

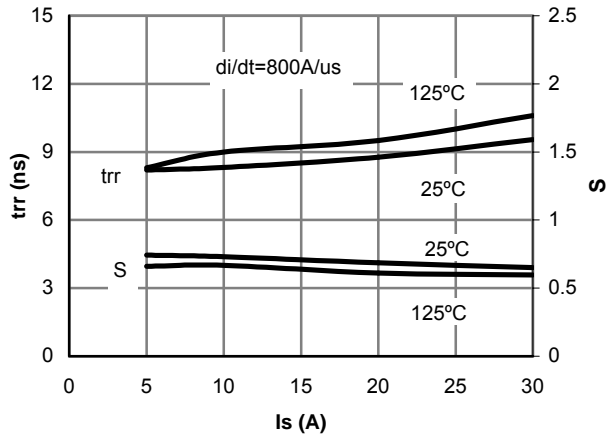

Figure 15: Diode Reverse Recovery Time and Soft Coefficient vs. Conduction Current

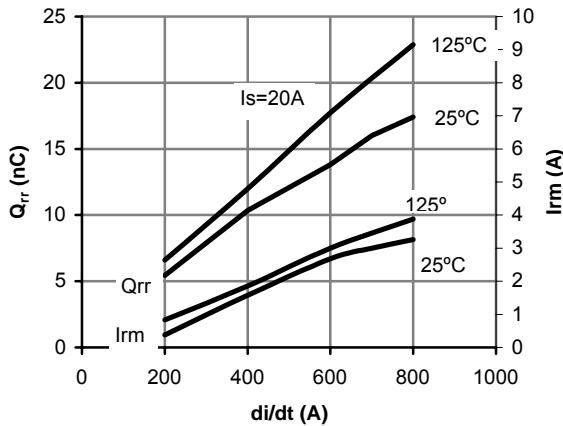

Figure 16: Diode Reverse Recovery Charge and Peak Current vs. di/dt

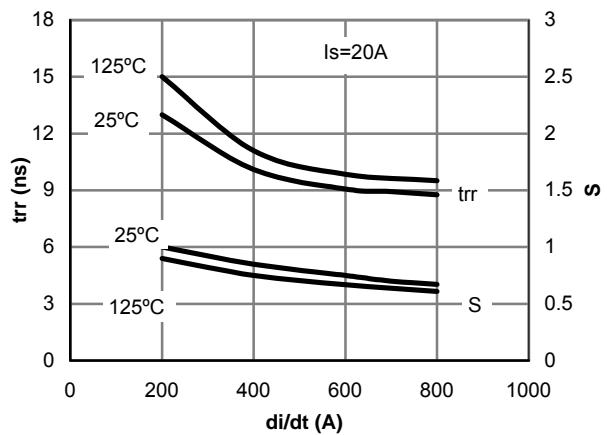
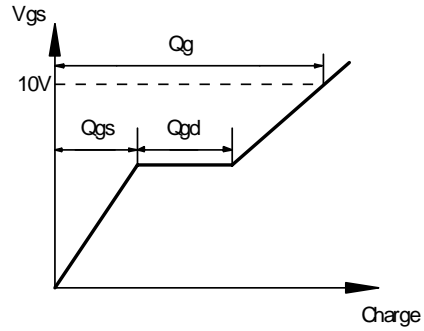
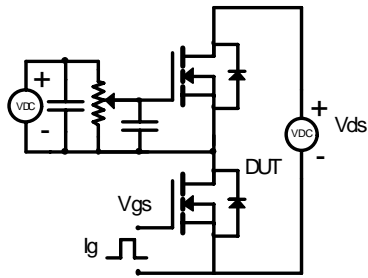
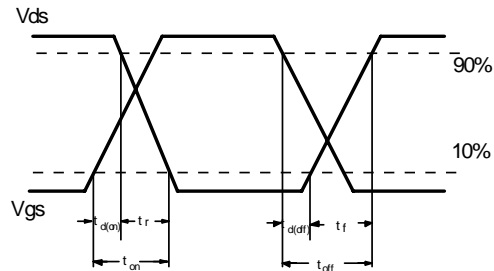
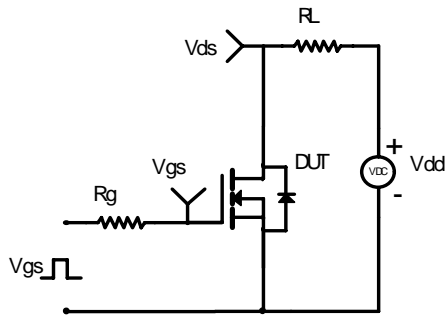

Figure 17: Diode Reverse Recovery Time and Soft Coefficient vs. di/dt

Gate Charge Test Circuit & Waveform



Resistive Switching Test Circuit & Waveforms



Unclamped Inductive Switching (UIS) Test Circuit & Waveforms

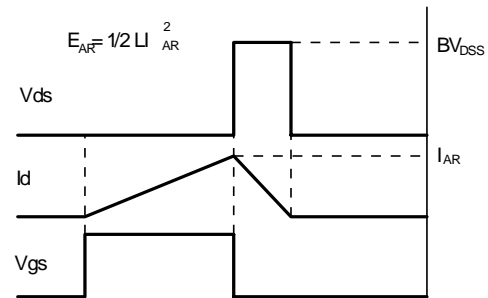
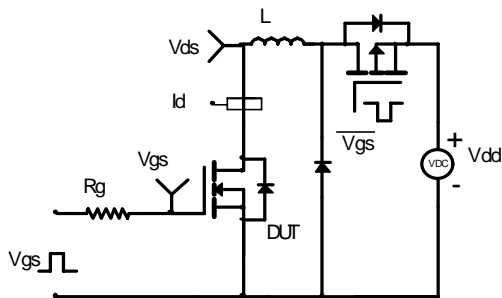

Diode Recovery Test Circuit & Waveforms

