

IPC-7132

Cost-effective Wallmount Chassis for ATX/mATX Motherboard and 10-slot Backplane



Features

- Support ATX/mATX M/B and 10-slot PICMG 1.3 backplane
- Shockproof drive bay for one 5.25" ODD and three 3.5" HDDs
- Thumb-screw for top cover easy opening
- Bidirectional option to mount chassis on wall or workbench
- Two front access USB ports

CE FCC

Specifications

		External	Internal
Disk Drive Bay	3.5"	1	2
	5.25"	1	-
Cooling	Fan	1 (12 cm/85 CFM)	
	Air Filters	Yes	
Front I/O interface	USB 2.0	2	
Miscellaneous	LED Indicators	Power, HDD	
	Control	Power Switch, System Reset Button	
	Rear panel	4x USB, 2x DB-9, 1x LPT port	
Environment	Temperature	Operating 0 ~ 40° C (32 ~ 104° F)	Non-operating -20 ~ 60° C (-4 ~ 140° F)
	Humidity	10 ~ 85 % @ 40° C, non-condensing	10 ~ 95 % @ 40° C, non-condensing
	Vibration (5-500 Hz)	1 Grms	2 G
	Shock	10 G (with 11 ms duration, half sine wave)	
	Physical Characteristics	Dimensions (W x H x D)	200 x 330 x 430 mm (7.9" x 13" x 16.9")
	Weight	9.96 kg (21.93 lb)	

Front View

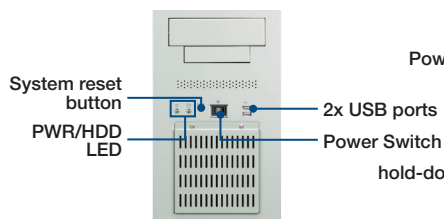

Inside View

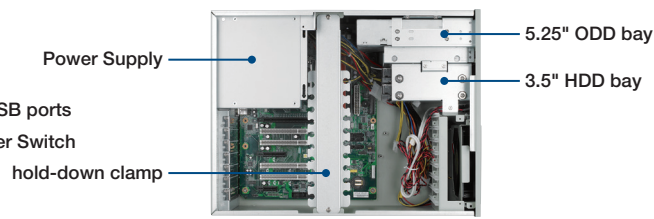

IPC-7132MB

Rear View

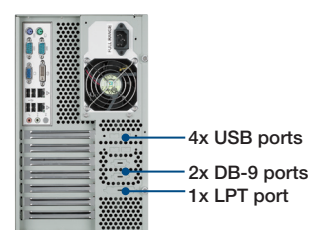

IPC-7132MB



Easy-to-maintain cooling fan

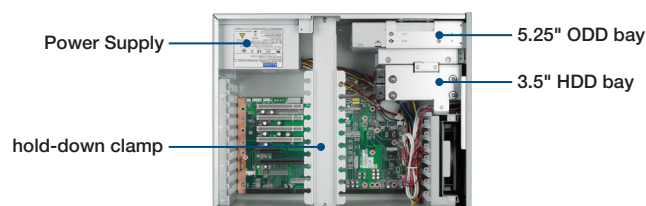

IPC-7132BP

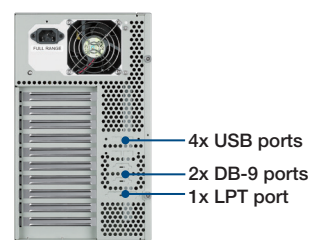

IPC-7132BP

Dimensions

Unit: mm [inch]

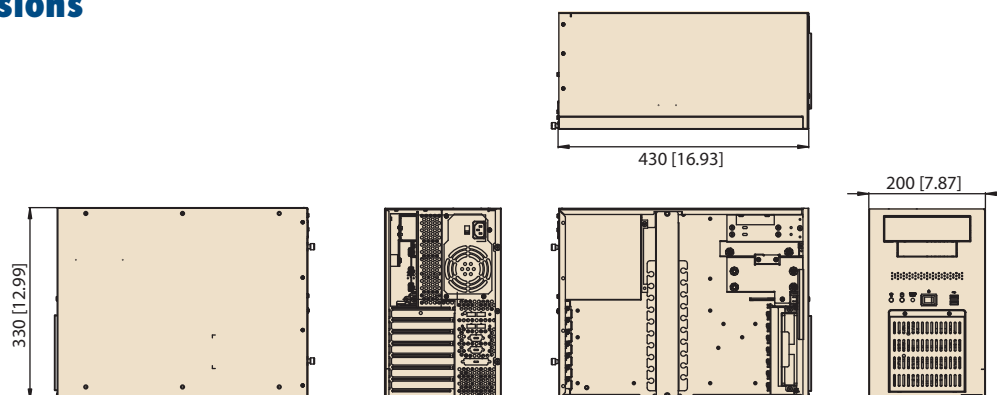

Installation

Unit: mm [inch]

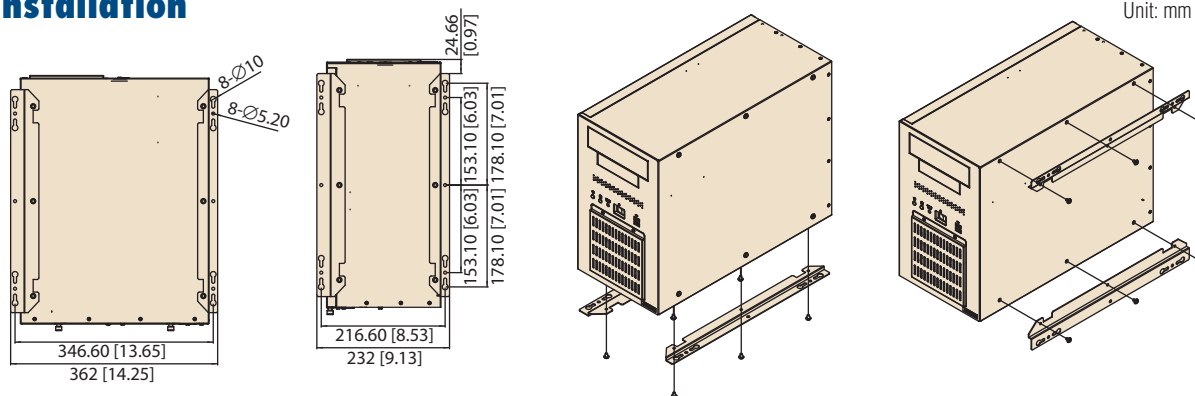

Ordering Information

Model Name	Power supply	Wattage	Switch Type
Motherboard Version			
IPC-7132MB-00XE	-	-	ATX
IPC-7132MB-25ZE	96PS-A250WPS2	250W	ATX
IPC-7132MB-30ZE	96PS-A300WPS2	300W	ATX
IPC-7132MB-40ZE	96PS-A400WPS2	400W	ATX
Backplane Version			
IPC-7132BP-00XE	-	-	ATX

Optional Accessories

Part Number	Description
IPC-DT-3120E	Mobile HDD tray for dual 2.5" SATA HDDs
1750006427	87.87 CFM, system fan 120 x 120 x 25.0 mm

Backplane Options

Model	PICMG 1.3	PCIe	PCI-X	PCI
PCE-5B09-06A1E	PICMG 1.3	1 (PCIe x4)	-	6
PCE-5B09-04A1E	PICMG 1.3	3 (PCIe x4)	-	4