

## Advanced PMU for Samsung S3C2416/S3C2450

### FEATURES

- Optimized for Samsung S3C2416/S3C2450 Processors
- Three Step-Down DC/DC Converters
- Four Low-Dropout Linear Regulators
- Integrated *ActivePath™* Charger
- I<sup>2</sup>C™ Serial Interface
- Advanced Enable/Disable Sequencing Controller
- Minimal External Components
- Tiny 5x5mm TQFN55-40 Package
  - 0.75mm Package Height
  - Pb-Free and RoHS Compliant

### GENERAL DESCRIPTION

The ACT8934 is a complete, cost effective, highly-efficient *ActivePMU™* power management solution, optimized for the unique power, voltage-sequencing, and control requirements of the Samsung S3C2416/S3C2450 processors.

This device features three step-down DC/DC converters and four low-noise, low-dropout linear regulators, along with a complete battery charging solution featuring the advanced *ActivePath™* system-power selection function.

The three DC/DC converters utilize a high-efficiency, fixed-frequency (2MHz), current-mode PWM control architecture that requires a minimum number of external components. Two DC/DCs are capable of supplying up to 900mA of output current, while the third supports up to 700mA. All four low-dropout linear regulators are high-performance, low-noise regulators that supply up to 150mA, 150mA, 250mA, and 250mA, respectively.

The ACT8934 is available in a compact, Pb-Free and RoHS-compliant TQFN55-40 package.

### TYPICAL APPLICATION DIAGRAM

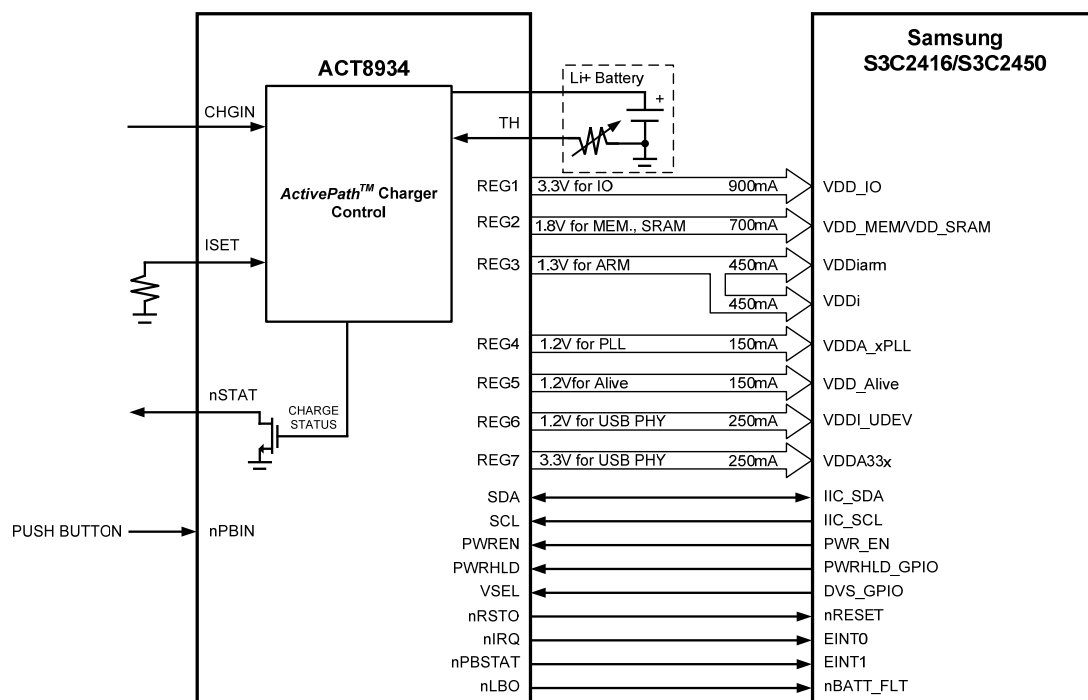

## TABLE OF CONTENTS

General Information .....	p. 01
Functional Block Diagram .....	p. 03
Ordering Information .....	p. 04
Pin Configuration .....	p. 04
Pin Descriptions .....	p. 05
Absolute Maximum Ratings .....	p. 07
I <sup>2</sup> C Interface Electrical Characteristics .....	p. 08
Global Register Map .....	p. 09
Register and Bit Descriptions .....	p. 10
System Control Electrical Characteristics.....	p. 15
Step-Down DC/DC Electrical Characteristics .....	p. 16
Low-Noise LDO Electrical Characteristics.....	p. 17
ActivePath™ Charger Electrical Characteristics.....	p. 18
Typical Performance Characteristics .....	p. 20
System control information .....	p. 27
Interfacing with the Samsung S3C2416/S3C2450.....	p. 27
Control Signals .....	p. 28
Push-Button Control .....	p. 29
Control Sequences.....	p. 29
Functional Description .....	p. 31
I <sup>2</sup> C Interface .....	p. 31
Voltage Monitor and Interrupt.....	p. 31
Thermal Shutdown .....	p. 32
Step-Down DC/DC Regulators .....	p. 33
General Description.....	p. 33
100% Duty Cycle Operation .....	p. 33
Synchronous Rectification.....	p. 33
Soft-Start .....	p. 33
Compensation .....	p. 33
Configuration Options.....	p. 33
OK[ ] and Output Fault Interrupt.....	p. 34
PCB Layout Considerations .....	p. 34
Low-Noise, Low-Dropout Linear Regulators.....	p. 35
General Description.....	p. 35
Output Current Limit .....	p. 35
Compensation .....	p. 35
Configuration Options.....	p. 35
OK[ ] and Output Fault Interrupt.....	p. 35
PCB Layout Considerations .....	p. 35
ActivePath™ Charger .....	p. 37
General Description.....	p. 37
ActivePath Architecture .....	p. 37
System Configuration Optimization.....	p. 37
Input Protection .....	p. 37
Battery Management.....	p. 37
Charge Current Programming .....	p. 38
Charger Input Interrupts .....	p. 38
Charge-Control State Machine.....	p. 40
State Machine Interrupts .....	p. 40
Thermal Regulation .....	p. 41
Charge Safety Timers .....	p. 41
Charger Timer Interrupts .....	p. 41
Charge Status Indicator.....	p. 41
Reverse-Current Protection .....	p. 41
Battery Temperature Monitoring .....	p. 41
Battery Temperature Interrupts .....	p. 42
TQFN55-40 Package Outline and Dimensions .....	p. 43

**FUNCTIONAL BLOCK DIAGRAM**

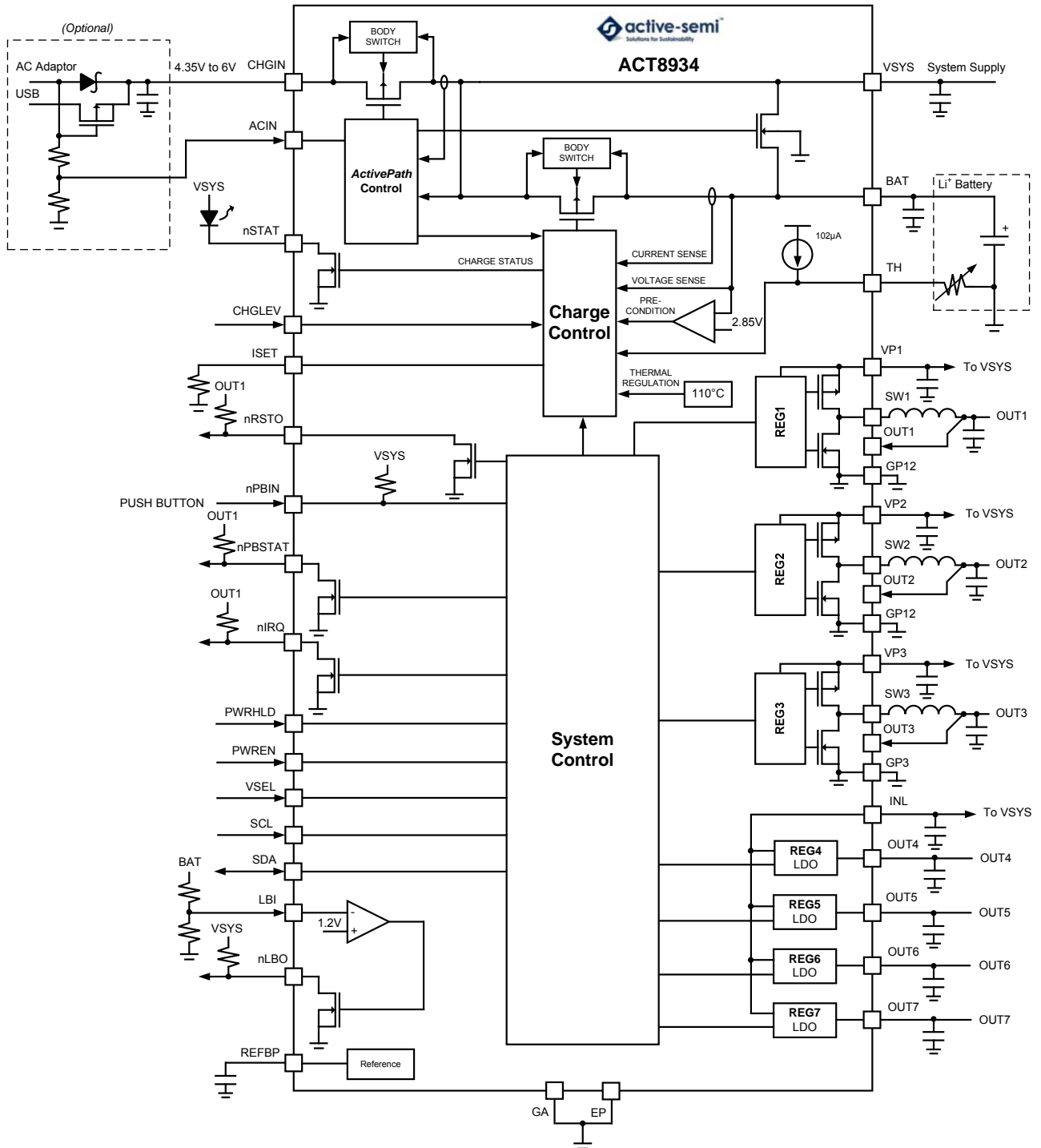

## ORDERING INFORMATION<sup>①②</sup>

PART NUMBER <sup>③</sup>	V <sub>OUT1</sub> /V <sub>STBY1</sub> <sup>④</sup>	V <sub>OUT2</sub> /V <sub>STBY2</sub>	V <sub>OUT3</sub> /V <sub>STBY3</sub>	V <sub>OUT4</sub>	V <sub>OUT5</sub>	V <sub>OUT6</sub>	V <sub>OUT7</sub>	PACKAGE	PINS	TEMPERATURE RANGE
ACT8934QJ133-T	3.3V/3.3V	1.8V/1.8V	1.3V/1.3V	1.2V	1.2V	1.2V	3.3V	TQFN55-40	40	-40°C to +85°C
ACT8934QJ258-T	3.3V/3.3V	1.8V/1.8V	1.25V/1.25V	1.2V	1.2V	1.2V	3.3V	TQFN55-40	40	-40°C to +85°C
ACT8934QJ333-T	3.3V/3.3V	1.8V/1.8V	1.3V/1.3V	1.2V	1.2V	1.2V	3.3V	TQFN55-40	40	-40°C to +85°C
ACT8934QJ458-T	3.3V/3.3V	1.8V/1.8V	1.25V/1.25V	1.2V	1.2V	1.2V	3.3V	TQFN55-40	40	-40°C to +85°C

①: All Active-Semi components are RoHS Compliant and with Pb-free plating otherwise specified.

②: Standard product options are listed in this table. Contact factory for custom options. Minimum order quantity is 12,000 units.

③: Refer to *Push-Button Control* section for the power control sequences of each part number.

④: To select V<sub>STBYx</sub> as the output regulation voltage for REGx, drive VSEL to logic high. V<sub>STBYx</sub> can be set by software via I<sup>2</sup>C interface.

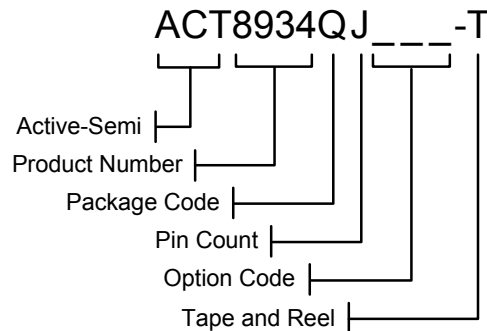

## PIN CONFIGURATION

TOP VIEW

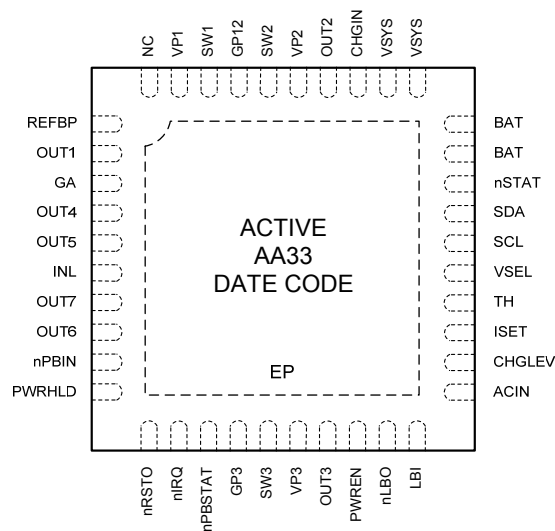

Thin - QFN (TQFN55-40)

## PIN DESCRIPTIONS

PIN	NAME	DESCRIPTION
1	REFBP	Reference Bypass. Connect a 0.047μF ceramic capacitor from REFBP to GA. This pin is discharged to GA in shutdown.
2	OUT1	Output Feedback Sense for REG1.
3	GA	Analog Ground. Connect GA directly to a quiet ground node. Connect GA, GP12 and GP3 together at a single point as close to the IC as possible.
4	OUT4	REG4 output. Capable of delivering up to 150mA of output current. Connect a 1.5μF ceramic capacitor from OUT4 to GA. The output is discharged to GA with 1.5kΩ resistor when disabled.
5	OUT5	REG5 output. Capable of delivering up to 150mA of output current. Connect a 1.5μF ceramic capacitor from OUT5 to GA. The output is discharged to GA with 1.5kΩ resistor when disabled.
6	INL	Power Input for REG4, REG5, REG6, and REG7. Bypass to GA with a high quality ceramic capacitor placed as close to the IC as possible.
7	OUT7	REG7 output. Capable of delivering up to 250mA of output current. Connect a 2.2μF ceramic capacitor from OUT7 to GA. The output is discharged to GA with 1.5kΩ resistor when disabled.
8	OUT6	REG6 output. Capable of delivering up to 250mA of output current. Connect a 2.2μF ceramic capacitor from OUT6 to GA. The output is discharged to GA with 1.5kΩ resistor when disabled.
9	nPBIN	Master Enable Input. Drive nPBIN to GA through a 50kΩ resistor to enable the IC, drive nPBIN directly to GA to assert a manual reset condition. Refer to the <i>nPBIN Multi-function Input</i> section for more information. nPBIN is internally pulled up to VSYS through a 35kΩ resistor.
10	PWRHLD	Power Hold Input. Refer to the <i>Control Sequences</i> section for more information.
11	nRSTO	Active Low Reset Output. See the <i>nRSTO Output</i> section for more information.
12	nIRQ	Open-Drain Interrupt Output. nIRQ is asserted any time an unmasked fault condition exists or a charger interrupt occurs. See the <i>nIRQ Output</i> section for more information.
13	nPBSTAT	Active-Low Open-Drain Push-Button Status Output. nPBSTAT is asserted low whenever the nPBIN is pushed, and is high-Z otherwise. See the <i>nPBSTAT Output</i> section for more information.
14	GP3	Power Ground for REG3. Connect GA, GP12, and GP3 together at a single point as close to the IC as possible.
15	SW3	Switching Node Output for REG3.
16	VP3	Power Input for REG3. Bypass to GP3 with a high quality ceramic capacitor placed as close to the IC as possible.
17	OUT3	Output Feedback Sense for REG3.
18	PWREN	Power Enable Input. Refer to the <i>Control Sequences</i> section for more information.
19	nLBO	Low Battery Indicator Output. nLBO is asserted low whenever the voltage at LBI is lower than 1.2V, and is high-Z otherwise. See the <i>Precision Voltage Detector</i> section for more information.
20	LBI	Low Battery Input. The input voltage is compared to 1.2V and the output of this comparison drives nLBO. See the <i>Precision Voltage Detector</i> section for more information.
21	ACIN	AC Input Supply Detection. See the <i>Charge Current Programming</i> section for more information.
22	CHGLEV	Charge Current Selection Input. See the <i>Charge Current Programming</i> section for more information.

## PIN DESCRIPTIONS CONT'D

PIN	NAME	DESCRIPTION
23	ISET	Charge Current Set. Program the charge current by connecting a resistor ( $R_{ISET}$ ) between ISET and GA. See the <i>Charge Current Programming</i> section for more information.
24	TH	Temperature Sensing Input. Connect to battery thermistor. TH is pulled up with a 102 $\mu$ A (typ) current internally. See the <i>Battery Temperature Monitoring</i> section for more information.
25	VSEL	Step-Down DC/DCs Output Voltage Selection. Drive to logic low to select default output voltage. Drive to logic high to select secondary output voltage. See the <i>Output Voltage Programming</i> section for more information.
26	SCL	Clock Input for I <sup>2</sup> C Serial Interface.
27	SDA	Data Input for I <sup>2</sup> C Serial Interface. Data is read on the rising edge of SCL.
28	nSTAT	Active-Low Open-Drain Charger Status Output. nSTAT has a 8mA (typ) current limit, allowing it to directly drive an indicator LED without additional external components. See the <i>Charge Status Indicator</i> section for more information.
29, 30	BAT	Battery Charger Output. Connect this pin directly to the battery anode (+ terminal)
31, 32	VSYS	System Output Pin. Bypass to GA with a 10 $\mu$ F or larger ceramic capacitor.
33	CHGIN	Power Input for the Battery Charger. Bypass CHGIN to GA with a capacitor placed as close to the IC as possible. The battery charger is automatically enabled when a valid voltage is present on CHGIN.
34	OUT2	Output Feedback Sense for REG2.
35	VP2	Power Input for REG2. Bypass to GP12 with a high quality ceramic capacitor placed as close to the IC as possible.
36	SW2	Switching Node Output for REG2.
37	GP12	Power Ground for REG1 and REG2. Connect GA, GP12 and GP3 together at a single point as close to the IC as possible.
38	SW1	Switching Node Output for REG1.
39	VP1	Power Input for REG1. Bypass to GP12 with a high quality ceramic capacitor placed as close to the IC as possible.
40	NC	No Connect. Not internally connected.
EP	EP	Exposed Pad. Must be soldered to ground on PCB.

## ABSOLUTE MAXIMUM RATINGS<sup>①</sup>

PARAMETER	VALUE	UNIT
VP1, VP2 to GP12 VP3 to GP3	-0.3 to +6	V
BAT, VSYS, INL to GA	-0.3 to +6	V
CHGIN to GA	-0.3 to +14	V
SW1, OUT1 to GP12	-0.3 to ( $V_{VP1} + 0.3$ )	V
SW2, OUT2 to GP12	-0.3 to ( $V_{VP2} + 0.3$ )	V
SW3, OUT3 to GP3	-0.3 to ( $V_{VP3} + 0.3$ )	V
nIRQ, nLBO, nPBSTAT, nRSTO, nSTAT to GA	-0.3 to +6	V
nPBIN, ACIN, CHGLEV, ISET, LBI, PWRHLD, PWREN, REFBP, SCL, SDA, TH, VSEL to GA	-0.3 to (VSYS+0.3)	V
OUT4, OUT5, OUT6, OUT7 to GA	-0.3 to ( $V_{INL} + 0.3$ )	V
GP12, GP3 to GA	-0.3 to +0.3	V
Operating Ambient Temperature	-40 to 85	°C
Maximum Junction Temperature	125	°C
Maximum Power Dissipation TQFN55-40 (Thermal Resistance $\theta_{JA} = 30^{\circ}\text{C/W}$ )	2.7	W
Storage Temperature	-65 to 150	°C
Lead Temperature (Soldering, 10 sec)	300	°C

①: Do not exceed these limits to prevent damage to the device. Exposure to absolute maximum rating conditions for long periods may affect device reliability.

## I<sup>2</sup>C INTERFACE ELECTRICAL CHARACTERISTICS

(V<sub>VSYS</sub> = 3.6V, T<sub>A</sub> = 25°C, unless otherwise specified.)

PARAMETER	TEST CONDITIONS	MIN	TYP	MAX	UNIT
SCL, SDA Input Low	V <sub>VSYS</sub> = 3.1V to 5.5V, T <sub>A</sub> = -40°C to 85°C			0.35	V
SCL, SDA Input High	V <sub>VSYS</sub> = 3.1V to 5.5V, T <sub>A</sub> = -40°C to 85°C	1.55			V
SDA Leakage Current				1	μA
SCL Leakage Current			8	18	μA
SDA Output Low	I <sub>OL</sub> = 5mA			0.35	V
SCL Clock Period, t <sub>SCL</sub>		1.5			μs
SDA Data Setup Time, t <sub>SU</sub>		100			ns
SDA Data Hold Time, t <sub>HD</sub>		300			ns
Start Setup Time, t <sub>ST</sub>	For Start Condition	100			ns
Stop Setup Time, t <sub>SP</sub>	For Stop Condition	100			ns

**Figure 1:**  
**I<sup>2</sup>C Compatible Serial Bus Timing**

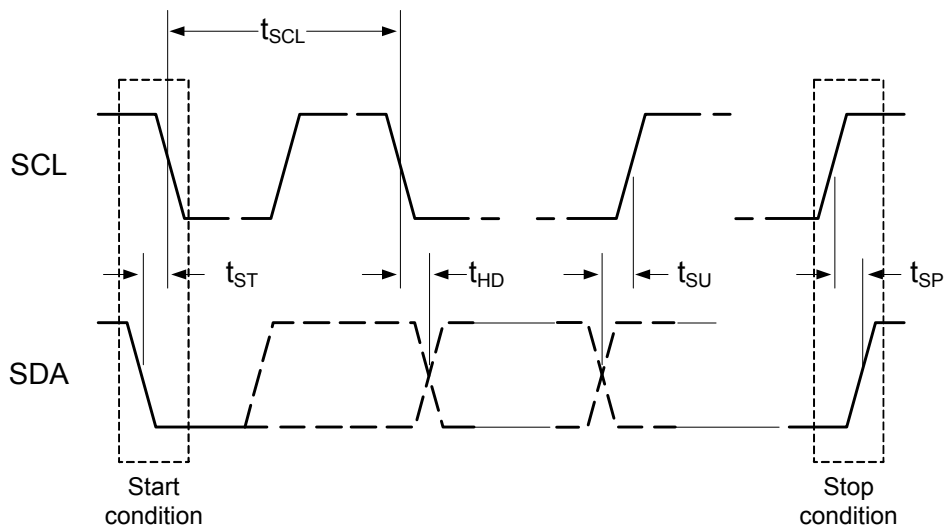



## GLOBAL REGISTER MAP

OUTPUT	ADDRESS		BITS							
			D7	D6	D5	D4	D3	D2	D1	D0
SYS	0x00	NAME	TRST	nSYSMODE	nSYSLEVMSK	nSYSSTAT	SYSLEV[3]	SYSLEV[2]	SYSLEV[1]	SYSLEV[0]
		DEFAULT <sup>①</sup>	0	1	0	R	0	1	1	1
SYS	0x01	NAME	Reserved	Reserved	MSTROFF	Reserved	SCRATCH	SCRATCH	SCRATCH	SCRATCH
		DEFAULT <sup>①</sup>	0	0	0	0	0	0	0	0
REG1	0x20	NAME	Reserved	Reserved	VSET1[5]	VSET1[4]	VSET1[3]	VSET1[2]	VSET1[1]	VSET1[0]
		DEFAULT <sup>①</sup>	0	0	1	1	1	0	0	1
REG1	0x21	NAME	Reserved	Reserved	VSET2[5]	VSET2[4]	VSET2[3]	VSET2[2]	VSET2[1]	VSET2[0]
		DEFAULT <sup>①</sup>	0	0	1	1	1	0	0	1
REG1	0x22	NAME	ON	PHASE	MODE	DELAY[2]	DELAY[1]	DELAY[0]	nFLTMSK	OK
		DEFAULT <sup>①</sup>	0	0	0	0	0	0	0	R
REG2	0x30	NAME	Reserved	Reserved	VSET1[5]	VSET1[4]	VSET1[3]	VSET1[2]	VSET1[1]	VSET1[0]
		DEFAULT <sup>①</sup>	0	0	1	0	0	1	0	0
REG2	0x31	NAME	Reserved	Reserved	VSET2[5]	VSET2[4]	VSET2[3]	VSET2[2]	VSET2[1]	VSET2[0]
		DEFAULT <sup>①</sup>	0	0	1	0	0	1	0	0
REG2	0x32	NAME	ON	PHASE	MODE	DELAY[2]	DELAY[1]	DELAY[0]	nFLTMSK	OK
		DEFAULT <sup>①</sup>	0	0	0	0	0	0	0	R
REG3	0x40	NAME	Reserved	Reserved	VSET1[5]	VSET1[4]	VSET1[3]	VSET1[2]	VSET1[1]	VSET1[0]
		DEFAULT <sup>①</sup>	0	0	0	1	1	0	1	0
REG3	0x41	NAME	Reserved	Reserved	VSET2[5]	VSET2[4]	VSET2[3]	VSET2[2]	VSET2[1]	VSET2[0]
		DEFAULT <sup>①</sup>	0	0	0	1	1	0	1	0
REG3	0x42	NAME	ON	Reserved	MODE	DELAY[2]	DELAY[1]	DELAY[0]	nFLTMSK	OK
		DEFAULT <sup>①</sup>	0	0	0	0	0	0	0	R
REG4	0x50	NAME	Reserved	Reserved	VSET[5]	VSET[4]	VSET[3]	VSET[2]	VSET[1]	VSET[0]
		DEFAULT <sup>①</sup>	0	0	0	1	1	0	0	0
REG4	0x51	NAME	ON	DIS	LOWIQ	DELAY[2]	DELAY[1]	DELAY[0]	nFLTMSK	OK
		DEFAULT <sup>①</sup>	0	1	0	0	0	0	0	R
REG5	0x54	NAME	Reserved	Reserved	VSET[5]	VSET[4]	VSET[3]	VSET[2]	VSET[1]	VSET[0]
		DEFAULT <sup>①</sup>	0	0	0	1	1	0	0	0
REG5	0x55	NAME	ON	DIS	LOWIQ	DELAY[2]	DELAY[1]	DELAY[0]	nFLTMSK	OK
		DEFAULT <sup>①</sup>	0	1	0	0	0	0	0	R
REG6	0x60	NAME	Reserved	Reserved	VSET[5]	VSET[4]	VSET[3]	VSET[2]	VSET[1]	VSET[0]
		DEFAULT <sup>①</sup>	0	0	0	1	1	0	0	0
REG6	0x61	NAME	ON	DIS	LOWIQ	DELAY[2]	DELAY[1]	DELAY[0]	nFLTMSK	OK
		DEFAULT <sup>①</sup>	0	1	0	0	0	0	0	R
REG7	0x64	NAME	Reserved	Reserved	VSET[5]	VSET[4]	VSET[3]	VSET[2]	VSET[1]	VSET[0]
		DEFAULT <sup>①</sup>	0	0	1	1	1	0	0	1
REG7	0x65	NAME	ON	DIS	LOWIQ	DELAY[2]	DELAY[1]	DELAY[0]	nFLTMSK	OK
		DEFAULT <sup>①</sup>	0	1	0	0	0	0	0	R
APCH	0x70	NAME	Reserved	Reserved	Reserved	Reserved	Reserved	Reserved	Reserved	Reserved
		DEFAULT <sup>①</sup>	0	1	0	1	0	0	0	0
APCH	0x71	NAME	SUSCHG	Reserved	TOTTIMO[1]	TOTTIMO[0]	PRETIMO[1]	PRETIMO[0]	OVPSET[1]	OVPSET[0]
		DEFAULT	0	0	1	0	1	0	0	0
APCH	0x78	NAME	TIMRSTAT	TEMPSTAT	INSTAT	CHGSTAT	TIMRDAT	TEMPCAT	INDAT	CHGDAT
		DEFAULT <sup>①</sup>	0	0	0	0	R	R	R	R
APCH	0x79	NAME	TIMRTOT	TEMPIN	INCON	CHGEOCIN	TIMRPRE	TEMPOUT	INDIS	CHGEOCOUT
		DEFAULT <sup>①</sup>	0	0	0	0	0	0	0	0
APCH	0x7A	NAME	Reserved	Reserved	CSTATE[0]	CSTATE[1]	Reserved	Reserved	ACINSTAT	Reserved
		DEFAULT <sup>①</sup>	0	0	R	R	R	R	R	R

①: Default values of ACT8934QJ133-T.

②: All bits are automatically cleared to default values when the input power is removed or falls below the system UVLO.

## REGISTER AND BIT DESCRIPTIONS

Table 1:

Global Register Map

OUTPUT	ADDRESS	BIT	NAME	ACCESS	DESCRIPTION
SYS	0x00	[7]	TRST	R/W	Reset Timer Setting. Defines the reset time-out threshold. Reset time-out is 65ms when value is 1, reset time-out is 260ms when value is 0. See <i>nRSTO Output</i> section for more information.
SYS	0x00	[6]	nSYSMODE	R/W	SYSLEV Mode Select. Defines the response to the SYSLEV voltage detector, 1: Generate an interrupt when V <sub>SYS</sub> falls below the programmed SYSLEV threshold, 0: automatic shutdown when V <sub>SYS</sub> falls below the programmed SYSLEV threshold.
SYS	0x00	[5]	nSYSLEVMSK	R/W	System Voltage Level Interrupt Mask. SYSLEV interrupt is masked by default, set to 1 to unmask this interrupt. See the <i>Programmable System Voltage Monitor</i> section for more information
SYS	0x00	[4]	nSYSSTAT	R	System Voltage Status. Value is 1 when V <sub>SYS</sub> is lower than the SYSLEV voltage threshold, value is 0 when V <sub>SYS</sub> is higher than the system voltage detection threshold.
SYS	0x00	[3:0]	SYSLEV	R/W	System Voltage Detect Threshold. Defines the SYSLEV voltage threshold. See the <i>Programmable System Voltage Monitor</i> section for more information.
SYS	0x01	[7:6]	-	R/W	Reserved.
SYS	0x01	[5]	MSTROFF	R/W	Master Off Control. Set bit to 1 to turn off REG1, REG2 and REG5. The bit will be automatically cleared to 0 when nPBIN is asserted or a valid CHGIN voltage is detected (for ACT8934QJ2XX only).
SYS	0x01	[4]	-	R/W	Reserved.
SYS	0x01	[3:0]	SCRATCH	R/W	Scratchpad Bits. Non-functional bits, maybe be used by user to store system status information. Volatile bits, which are cleared when system voltage falls below UVLO threshold.
REG1	0x20	[7:6]	-	R	Reserved.
REG1	0x20	[5:0]	VSET1	R/W	Primary Output Voltage Selection. Valid when VSEL is driven low. See the <i>Output Voltage Programming</i> section for more information.
REG1	0x21	[7:6]	-	R	Reserved.
REG1	0x21	[5:0]	VSET2	R/W	Secondary Output Voltage Selection. Valid when VSEL is driven high. See the <i>Output Voltage Programming</i> section for more information.
REG1	0x22	[7]	ON	R/W	Regulator Enable Bit. Set bit to 1 to enable the regulator, clear bit to 0 to disable the regulator.
REG1	0x22	[6]	PHASE	R/W	Regulator Phase Control. Set bit to 1 for the regulator to operate 180° out of phase with the oscillator, clear bit to 0 for the regulator to operate in phase with the oscillator.
REG1	0x22	[5]	MODE	R/W	Regulator Mode Select. Set bit to 1 for fixed-frequency PWM under all load conditions, clear bit to 0 to transit to power-savings mode under light-load conditions.
REG1	0x22	[4:2]	DELAY	R/W	Regulator Turn-On Delay Control. See the <i>REG1, REG2, REG3 Turn-on Delay</i> section for more information.
REG1	0x22	[1]	nFLTMSK	R/W	Regulator Fault Mask Control. Set bit to 1 enable fault-interrupts, clear bit to 0 to disable fault-interrupts.
REG1	0x22	[0]	OK	R	Regulator Power-OK Status. Value is 1 when output voltage exceeds the power-OK threshold, value is 0 otherwise.
REG2	0x30	[7:6]	-	R	Reserved.
REG2	0x30	[5:0]	VSET1	R/W	Primary Output Voltage Selection. Valid when VSEL is driven low. See the <i>Output Voltage Programming</i> section for more information.
REG2	0x31	[7:6]	-	R	Reserved.

## REGISTER AND BIT DESCRIPTIONS CONT'D

OUTPUT	ADDRESS	BIT	NAME	ACCESS	DESCRIPTION
REG2	0x31	[5:0]	VSET2	R/W	Secondary Output Voltage Selection. Valid when VSEL is driven high. See the <i>Output Voltage Programming</i> section for more information.
REG2	0x32	[7]	ON	R/W	Regulator Enable Bit. Set bit to 1 to enable the regulator, clear bit to 0 to disable the regulator.
REG2	0x32	[6]	PHASE	R/W	Regulator Phase Control. Set bit to 1 for the regulator to operate 180° out of phase with the oscillator, clear bit to 0 for the regulator to operate in phase with the oscillator.
REG2	0x32	[5]	MODE	R/W	Regulator Mode Select. Set bit to 1 for fixed-frequency PWM under all load conditions, clear bit to 0 to transit to power-savings mode under light-load conditions.
REG2	0x32	[4:2]	DELAY	R/W	Regulator Turn-On Delay Control. See the <i>REG1, REG2, REG3 Turn-on Delay</i> section for more information.
REG2	0x32	[1]	nFLTMSK	R/W	Regulator Fault Mask Control. Set bit to 1 enable fault-interrupts, clear bit to 0 to disable fault-interrupts.
REG2	0x32	[0]	OK	R	Regulator Power-OK Status. Value is 1 when output voltage exceeds the power-OK threshold, value is 0 otherwise.
REG3	0x40	[7:6]	-	R	Reserved.
REG3	0x40	[5:0]	VSET1	R/W	Primary Output Voltage Selection. Valid when VSEL is driven low. See the <i>Output Voltage Programming</i> section for more information.
REG3	0x41	[7:6]	-	R	Reserved.
REG3	0x41	[5:0]	VSET2	R/W	Secondary Output Voltage Selection. Valid when VSEL is driven high. See the <i>Output Voltage Programming</i> section for more information.
REG3	0x42	[7]	ON	R/W	Regulator Enable Bit. Set bit to 1 to enable the regulator, clear bit to 0 to disable the regulator.
REG3	0x42	[6]	-	R/W	Reserved.
REG3	0x42	[5]	MODE	R/W	Regulator Mode Select. Set bit to 1 for fixed-frequency PWM under all load conditions, clear bit to 0 to transit to power-savings mode under light-load conditions.
REG3	0x42	[4:2]	DELAY	R/W	Regulator Turn-On Delay Control. See the <i>REG1, REG2, REG3 Turn-on Delay</i> section for more information.
REG3	0x42	[1]	nFLTMSK	R/W	Regulator Fault Mask Control. Set bit to 1 enable fault-interrupts, clear bit to 0 to disable fault-interrupts.
REG3	0x42	[0]	OK	R	Regulator Power-OK Status. Value is 1 when output voltage exceeds the power-OK threshold, value is 0 otherwise.
REG4	0x50	[7:6]	-	R	Reserved.
REG4	0x50	[5:0]	VSET	R/W	Output Voltage Selection. See the <i>Output Voltage Programming</i> section for more information.
REG4	0x51	[7]	ON	R/W	Regulator Enable Bit. Set bit to 1 to enable the regulator, clear bit to 0 to disable the regulator.
REG4	0x51	[6]	DIS	R/W	Output Discharge Control. When activated, LDO output is discharged to GA through 1.5kΩ resistor when in shutdown. Set bit to 1 to enable output voltage discharge in shutdown, clear bit to 0 to disable this function.
REG4	0x51	[5]	LOWIQ	R/W	LDO Low-IQ Mode Control. Set bit to 1 for low-power operating mode, clear bit to 0 for normal mode.
REG4	0x51	[4:2]	DELAY	R/W	Regulator Turn-On Delay Control. See the <i>REG4, REG5, REG6, REG7 Turn-on Delay</i> section for more information.
REG4	0x51	[1]	nFLTMSK	R/W	Regulator Fault Mask Control. Set bit to 1 enable fault-interrupts, clear bit to 0 to disable fault-interrupts.

## REGISTER AND BIT DESCRIPTIONS CONT'D

OUTPUT	ADDRESS	BIT	NAME	ACCESS	DESCRIPTION
REG4	0x51	[0]	OK	R	Regulator Power-OK Status. Value is 1 when output voltage exceeds the power-OK threshold, value is 0 otherwise.
REG5	0x54	[7:6]	-	R	Reserved.
REG5	0x54	[5:0]	VSET	R/W	Output Voltage Selection. See the <i>Output Voltage Programming</i> section for more information.
REG5	0x55	[7]	ON	R/W	Regulator Enable Bit. Set bit to 1 to enable the regulator, clear bit to 0 to disable the regulator.
REG5	0x55	[6]	DIS	R/W	Output Discharge Control. When activated, LDO output is discharged to GA through 1.5kΩ resistor when in shutdown. Set bit to 1 to enable output voltage discharge in shutdown, clear bit to 0 to disable this function.
REG5	0x55	[5]	LOWIQ	R/W	LDO Low-IQ Mode Control. Set bit to 1 for low-power operating mode, clear bit to 0 for normal mode.
REG5	0x55	[4:2]	DELAY	R/W	Regulator Turn-On Delay Control. See the <i>REG4, REG5, REG6, REG7 Turn-on Delay</i> section for more information.
REG5	0x55	[1]	nFLTMSK	R/W	Regulator Fault Mask Control. Set bit to 1 enable fault-interrupts, clear bit to 0 to disable fault-interrupts.
REG5	0x55	[0]	OK	R	Regulator Power-OK Status. Value is 1 when output voltage exceeds the power-OK threshold, value is 0 otherwise.
REG6	0x60	[7:6]	-	R	Reserved.
REG6	0x60	[5:0]	VSET	R/W	Output Voltage Selection. See the <i>Output Voltage Programming</i> section for more information.
REG6	0x61	[7]	ON	R/W	Regulator Enable Bit. Set bit to 1 to enable the regulator, clear bit to 0 to disable the regulator.
REG6	0x61	[6]	DIS	R/W	Output Discharge Control. When activated, LDO output is discharged to GA through 1.5kΩ resistor when in shutdown. Set bit to 1 to enable output voltage discharge in shutdown, clear bit to 0 to disable this function.
REG6	0x61	[5]	LOWIQ	R/W	LDO Low-IQ Mode Control. Set bit to 1 for low-power operating mode, clear bit to 0 for normal mode.
REG6	0x61	[4:2]	DELAY	R/W	Regulator Turn-On Delay Control. See the <i>REG4, REG5, REG6, REG7 Turn-on Delay</i> section for more information.
REG6	0x61	[1]	nFLTMSK	R/W	Regulator Fault Mask Control. Set bit to 1 enable fault-interrupts, clear bit to 0 to disable fault-interrupts.
REG6	0x61	[0]	OK	R	Regulator Power-OK Status. Value is 1 when output voltage exceeds the power-OK threshold, value is 0 otherwise.
REG7	0x64	[7:6]	-	R	Reserved.
REG7	0x64	[5:0]	VSET	R/W	Output Voltage Selection. See the <i>Output Voltage Programming</i> section for more information.
REG7	0x65	[7]	ON	R/W	Regulator Enable Bit. Set bit to 1 to enable the regulator, clear bit to 0 to disable the regulator.
REG7	0x65	[6]	DIS	R/W	Output Discharge Control. When activated, LDO output is discharged to GA through 1.5kΩ resistor when in shutdown. Set bit to 1 to enable output voltage discharge in shutdown, clear bit to 0 to disable this function.
REG7	0x65	[5]	LOWIQ	R/W	LDO Low-IQ Mode Control. Set bit to 1 for low-power operating mode, clear bit to 0 for normal mode.
REG7	0x65	[4:2]	DELAY	R/W	Regulator Turn-On Delay Control. See the <i>REG4, REG5, REG6, REG7 Turn-on Delay</i> section for more information.
REG7	0x65	[1]	nFLTMSK	R/W	Regulator Fault Mask Control. Set bit to 1 enable fault-interrupts, clear bit to 0 to disable fault-interrupts.
REG7	0x65	[0]	OK	R	Regulator Power-OK Status. Value is 1 when output voltage exceeds the power-OK threshold, value is 0 otherwise.

## REGISTER AND BIT DESCRIPTIONS CONT'D

OUTPUT	ADDRESS	BIT	NAME	ACCESS	DESCRIPTION
APCH	0x70	[7:0]	-	R	Reserved.
APCH	0x71	[7]	SUSCHG	R/W	Charge Suspend Control Input. Set bit to 1 to suspend charging, clear bit to 0 to allow charging to resume.
APCH	0x71	[6]	-	R/W	Reserved.
APCH	0x71	[5:4]	TOTTIMO	R/W	Total Charge Time-out Selection. See the <i>Charge Safety Timers</i> section for more information.
APCH	0x71	[3:2]	PRETIMO	R/W	Precondition Charge Time-out Selection. See the <i>Charge Safety Timers</i> section for more information.
APCH	0x71	[1:0]	OVPSET	R/W	Input Over-Voltage Protection Threshold Selection. See the <i>Input Over-Voltage Protection</i> section for more information.
APCH	0x78	[7]	TIMRSTAT <sup>Ⓣ</sup>	R/W	Charge Time-out Interrupt Status. Set this bit with TIMRPRE[ ] and/or TIMRTOT[ ] to 1 to generate an interrupt when charge safety timers expire, read this bit to get charge time-out interrupt status. See the <i>Charge Safety Timers</i> section for more information.
APCH	0x78	[6]	TEMPSTAT <sup>Ⓣ</sup>	R/W	Battery Temperature Interrupt Status. Set this bit with TEMPIN[ ] and/or TEMPOUT[ ] to 1 to generate an interrupt when a battery temperature event occurs, read this bit to get the battery temperature interrupt status. See the <i>Battery Temperature Monitoring</i> section for more information.
APCH	0x78	[5]	INSTAT	R/W	Input Voltage Interrupt Status. Set this bit with INCON[ ] and/or INDIS[ ] to generate an interrupt when UVLO or OVP condition occurs, read this bit to get the input voltage interrupt status. See the <i>Charge Current Programming</i> section for more information.
APCH	0x78	[4]	CHGSTAT <sup>Ⓣ</sup>	R/W	Charge State Interrupt Status. Set this bit with CHGEOCIN[ ] and/or CHGEOCOUT[ ] to 1 to generate an interrupt when the state machine gets in or out of EOC state, read this bit to get the charger state interrupt status. See the <i>State Machine Interrupts</i> section for more information.
APCH	0x78	[3]	TIMRDAT <sup>Ⓣ</sup>	R	Charge Timer Status. Value is 1 when precondition time-out or total charge time-out occurs. Value is 0 in other case.
APCH	0x78	[2]	TEMPDAT <sup>Ⓣ</sup>	R	Temperature Status. Value is 0 when battery temperature is outside of valid range. Value is 1 when battery temperature is inside of valid range.
APCH	0x78	[1]	INDAT	R	Input Voltage Status. Value is 1 when a valid input at CHGIN is present. Value is 0 when a valid input at CHGIN is not present.
APCH	0x78	[0]	CHGDAT <sup>Ⓣ</sup>	R	Charge State Machine Status. Value is 1 indicates the charger state machine is in EOC state, value is 0 indicates the charger state machine is in other states.
APCH	0x79	[7]	TIMRTOT	R/W	Total Charge Time-out Interrupt control. Set both this bit and TIMRSTAT[ ] to 1 to generate an interrupt when a total charge time-out occurs. See the <i>Charge Safety Timers</i> section for more information.
APCH	0x79	[6]	TEMPIN	R/W	Battery Temperature Interrupt Control. Set both this bit and TEMPSTAT[ ] to 1 to generate an interrupt when the battery temperature goes into the valid range. See the <i>Battery Temperature Monitoring</i> section for more information.
APCH	0x79	[5]	INCON	R/W	Input Voltage Interrupt Control. Set both this bit and INSTAT[ ] to 1 to generate an interrupt when CHGIN input voltage goes into the valid range. See the <i>Charge Current Programming</i> section for more information.

Ⓣ: Valid only when CHGIN UVLO Threshold < V<sub>CHGIN</sub> < CHGIN OVP Threshold.

## REGISTER AND BIT DESCRIPTIONS CONT'D

OUTPUT	ADDRESS	BIT	NAME	ACCESS	DESCRIPTION
APCH	0x79	[4]	CHGEOCIN	R/W	Charge State Interrupt Control. Set both this bit and CHGSTAT[ ] to 1 to generate an interrupt when the state machine goes into the EOC state. See the <i>State Machine Interrupts</i> section for more information.
APCH	0x79	[3]	TIMRPRE	R/W	PRECHARGE Time-out Interrupt control. Set both this bit and TIMRSTAT[ ] to 1 to generate an interrupt when a PRECHARGE time-out occurs. See the <i>Charge Safety Timers</i> section for more information.
APCH	0x79	[2]	TEMPOUT	R/W	Battery Temperature Interrupt Control. Set both this bit and TEMPSTAT[ ] to 1 to generate an interrupt when the battery temperature goes out of the valid range. See the <i>Battery Temperature Monitoring</i> section for more information.
APCH	0x79	[1]	INDIS	R/W	Input Voltage Interrupt Control. Set both this bit and INSTAT[ ] to 1 to generate an interrupt when CHGIN input voltage goes out of the valid range. See the <i>Charge Current Programming</i> section for more information.
APCH	0x79	[0]	CHGEOCOUT	R/W	Charge State Interrupt Control. Set both this bit and CHGSTAT[ ] to 1 to generate an interrupt when the state machines jumps out of the EOC state. See the <i>State Machine Interrupts</i> section for more information.
APCH	0x7A	[7:6]	-	R	Reserved.
APCH	0x7A	[5:4]	CSTATE	R	Charge State. Values indicate the current charging state. See the <i>State Machine Interrupts</i> section for more information.
APCH	0x7A	[3:2]	-	R	Reserved.
APCH	0x7A	[1]	ACINSTAT	R	ACIN Status. Indicates the state of the ACIN input, typically in order to identify the type of input supply connected. Value is 1 when ACIN is above the 1.2V precision threshold, value is 0 when ACIN is below this threshold.
APCH	0x7A	[0]	-	R	Reserved.

## SYSTEM CONTROL ELECTRICAL CHARACTERISTICS

( $V_{SYS} = 3.6V$ ,  $T_A = 25^\circ C$ , unless otherwise specified.)

PARAMETER	TEST CONDITIONS	MIN	TYP	MAX	UNIT
Input Voltage Range		2.7		5.5	V
UVLO Threshold Voltage	$V_{SYS}$ Rising	2.2	2.45	2.65	V
UVLO Hysteresis	$V_{SYS}$ Falling		200		mV
Supply Current	REG1, REG2 and REG5 Enabled. REG3, REG4, REG6 and REG7 Disabled		250		$\mu A$
	REG1, REG2, REG3, REG4 and REG5 Enabled. REG6 and REG7 Disabled		350		
	REG1, REG2, REG3, REG4, REG5, REG6, REG7 Enabled		420		
Shutdown Supply Current	All Regulators Disabled		8	18	$\mu A$
Oscillator Frequency		1.8	2	2.2	MHz
Logic High Input Voltage <sup>①</sup>		1.4			V
Logic Low Input Voltage				0.4	V
Leakage Current	$V_{nIRQ} = V_{nRSTO} = 4.2V$			1	$\mu A$
LBI Threshold Voltage	$V_{BAT}$ Falling	1.03	1.2	1.31	V
LBI Hysteresis Threshold	$V_{BAT}$ Rising		200		mV
Low Level Output Voltage <sup>②</sup>	$I_{SINK} = 5mA$			0.35	V
nRSTO Delay			260 <sup>③</sup>		ms
Thermal Shutdown Temperature	Temperature rising		160		$^\circ C$
Thermal Shutdown Hysteresis			20		$^\circ C$

①: PWRHLD, PWREN, VSEL are logic inputs.

②: nLBO, nPBSTAT, nIRQ, nRSTO are open drain outputs.

③: Typical value shown. Actual value may vary from 227.9ms to 291.2ms.

## STEP-DOWN DC/DC ELECTRICAL CHARACTERISTICS

( $V_{VP1} = V_{VP2} = V_{VP3} = 3.6V$ ,  $T_A = 25^\circ C$ , unless otherwise specified.)

PARAMETER	CONDITIONS	MIN	TYP	MAX	UNIT
Operating Voltage Range		2.7		5.5	V
UVLO Threshold	Input Voltage Rising	2.5	2.6	2.7	V
UVLO Hysteresis	Input Voltage Falling		100		mV
Quiescent Supply Current	Regulator Enabled		65	90	$\mu A$
Shutdown Current	$V_{VP} = 5.5V$ , Regulator Disabled		0	1	$\mu A$
Output Voltage Accuracy	$V_{OUT} \geq 1.2V$ , $I_{OUT} = 10mA$	-1%	$V_{NOM}^{\textcircled{1}}$	1%	V
	$V_{OUT} < 1.2V$ , $I_{OUT} = 10mA$	-2%	$V_{NOM}^{\textcircled{1}}$	2%	
Line Regulation	$V_{VP} = \text{Max}(V_{NOM}^{\textcircled{1}} + 1, 3.2V)$ to 5.5V		0.15		%/V
Load Regulation	$I_{OUT} = 10mA$ to $I_{MAX}^{\textcircled{2}}$		0.0017		%/mA
Power Good Threshold	$V_{OUT}$ Rising		93		% $V_{NOM}$
Power Good Hysteresis	$V_{OUT}$ Falling		2		% $V_{NOM}$
Oscillator Frequency	$V_{OUT} \geq 20\%$ of $V_{NOM}$	1.8	2	2.2	MHz
	$V_{OUT} = 0V$		500		kHz
Soft-Start Period			400		$\mu s$
Minimum On-Time			75		ns
<b>REG1</b>					
Maximum Output Current		0.9			A
Current Limit		1.2	1.4	1.7	A
PMOS On-Resistance	$I_{SW1} = -100mA$		0.18		$\Omega$
NMOS On-Resistance	$I_{SW1} = 100mA$		0.16		$\Omega$
SW1 Leakage Current	$V_{VP1} = 5.5V$ , $V_{SW1} = 0$ or 5.5V		0	1	$\mu A$
<b>REG2</b>					
Maximum Output Current		0.7			A
Current Limit		0.9	1.1	1.3	A
PMOS On-Resistance	$I_{SW2} = -100mA$		0.21		$\Omega$
NMOS On-Resistance	$I_{SW2} = 100mA$		0.16		$\Omega$
SW2 Leakage Current	$V_{VP2} = 5.5V$ , $V_{SW2} = 0$ or 5.5V		0	1	$\mu A$
<b>REG3</b>					
Maximum Output Current		0.9			A
Current Limit		1.2	1.4	1.7	A
PMOS On-Resistance	$I_{SW3} = -100mA$		0.18		$\Omega$
NMOS On-Resistance	$I_{SW3} = 100mA$		0.16		$\Omega$
SW3 Leakage Current	$V_{VP3} = 5.5V$ , $V_{SW3} = 0$ or 5.5V		0	1	$\mu A$

$\textcircled{1}$ :  $V_{NOM}$  refers to the nominal output voltage level for  $V_{OUT}$  as defined by the *Ordering Information* section.

$\textcircled{2}$ :  $I_{MAX}$  Maximum Output Current.



## LOW-NOISE LDO ELECTRICAL CHARACTERISTICS

( $V_{INL} = 3.6V$ ,  $C_{OUT4} = C_{OUT5} = 1.5\mu F$ ,  $C_{OUT6} = C_{OUT7} = 2.2\mu F$ ,  $LOWIQ[ ] = [0]$ ,  $T_A = 25^\circ C$ , unless otherwise specified.)

PARAMETER	TEST CONDITIONS	MIN	TYP	MAX	UNIT
Operating Voltage Range		2.5		5.5	V
Output Voltage Accuracy	$V_{OUT} \geq 1.2V$ , $T_A = 25^\circ C$ , $I_{OUT} = 10mA$	-1%	$V_{NOM}^{\textcircled{1}}$	2%	V
	$V_{OUT} < 1.2V$ , $T_A = 25^\circ C$ , $I_{OUT} = 10mA$	-2%	$V_{NOM}^{\textcircled{1}}$	4%	
Line Regulation	$V_{INL} = \text{Max}(V_{OUT} + 0.5V, 3.6V)$ to 5.5V $LOWIQ[ ] = [0]$		0.05		mV/V
	$V_{INL} = \text{Max}(V_{OUT} + 0.5V, 3.6V)$ to 5.5V $LOWIQ[ ] = [1]$		0.5		
Load Regulation	$I_{OUT} = 1mA$ to $IMAX^{\textcircled{2}}$		0.08		V/A
Power Supply Rejection Ratio	$f = 1kHz$ , $I_{OUT} = 20mA$ , $V_{OUT} = 1.2V$		75		dB
	$f = 10kHz$ , $I_{OUT} = 20mA$ , $V_{OUT} = 1.2V$		65		
Supply Current per Output	Regulator Enabled, $LOWIQ[ ] = [0]$		37	60	$\mu A$
	Regulator Enabled, $LOWIQ[ ] = [1]$		31	52	
	Regulator Disabled		0	1	
Soft-Start Period	$V_{OUT} = 2.9V$		140		$\mu s$
Power Good Threshold	$V_{OUT}$ Rising		89		%
Power Good Hysteresis	$V_{OUT}$ Falling		3		%
Output Noise	$I_{OUT} = 20mA$ , $f = 10Hz$ to $100kHz$ , $V_{OUT} = 1.2V$		50		$\mu V_{RMS}$
Discharge Resistance	LDO Disabled, $DIS[ ] = 1$		1.5		k $\Omega$
<b>REG4</b>					
Dropout Voltage <sup>③</sup>	$I_{OUT} = 80mA$ , $V_{OUT} > 3.1V$		90	180	mV
Maximum Output Current		150			mA
Current Limit <sup>④</sup>	$V_{OUT} = 95\%$ of regulation voltage	200			mA
Stable $C_{OUT4}$ Range		1.5		20	$\mu F$
<b>REG5</b>					
Dropout Voltage	$I_{OUT} = 80mA$ , $V_{OUT} > 3.1V$		140	280	mV
Maximum Output Current		150			mA
Current Limit	$V_{OUT} = 95\%$ of regulation voltage	200			mA
Stable $C_{OUT5}$ Range		1.5		20	$\mu F$
<b>REG6</b>					
Dropout Voltage	$I_{OUT} = 120mA$ , $V_{OUT} > 3.1V$		90	180	mV
Maximum Output Current		250			mA
Current Limit	$V_{OUT} = 95\%$ of regulation voltage	300			mA
Stable $C_{OUT6}$ Range		2.2		20	$\mu F$
<b>REG7</b>					
Dropout Voltage	$I_{OUT} = 120mA$ , $V_{OUT} > 3.1V$		140	280	mV
Maximum Output Current		250			mA
Current Limit	$V_{OUT} = 95\%$ of regulation voltage	300			mA
Stable $C_{OUT7}$ Range		2.2		20	$\mu F$

①:  $V_{NOM}$  refers to the nominal output voltage level for  $V_{OUT}$  as defined by the *Ordering Information* section.

②:  $IMAX$  Maximum Output Current.

③: Dropout Voltage is defined as the differential voltage between input and output when the output voltage drops 100mV below the regulation voltage (for 3.1V output voltage or higher).

④: LDO current limit is defined as the output current at which the output voltage drops to 95% of the respective regulation voltage. Under heavy overload conditions the output current limit folds back by 30% (typ).

## ActivePath™ CHARGER ELECTRICAL CHARACTERISTICS

( $V_{CHGIN} = 5.0V$ ,  $T_A = 25^\circ C$ , unless otherwise specified.)

PARAMETER	TEST CONDITIONS	MIN	TYP	MAX	UNIT
<b>ActivePath</b>					
CHGIN Operating Voltage Range		4.35		6.0	V
CHGIN UVLO Threshold	CHGIN Voltage Rising	3.1	3.5	3.9	V
CHGIN UVLO Hysteresis	CHGIN Voltage Falling		0.5		V
CHGIN OVP Threshold	CHGIN Voltage Rising	6.0	6.6	7.2	V
CHGIN OVP Hysteresis	CHGIN Voltage Falling		0.4		V
CHGIN Supply Current	$V_{CHGIN} < V_{UVLO}$		35	70	$\mu A$
	$V_{CHGIN} < V_{BAT} + 50mV$ , $V_{CHGIN} > V_{UVLO}$		100	200	$\mu A$
	$V_{CHGIN} > V_{BAT} + 150mV$ , $V_{CHGIN} > V_{UVLO}$ Charger disabled, $I_{V_{SYS}} = 0mA$		1.3	2.0	mA
CHGIN to V <sub>SYS</sub> On-Resistance	$I_{V_{SYS}} = 100mA$		0.3		$\Omega$
CHGIN to V <sub>SYS</sub> Current Limit	ACIN = V <sub>SYS</sub>	1.5	2		A
	ACIN = GA, CHGLEV = GA	80	90	100	mA
	ACIN = GA, CHGLEV = V <sub>SYS</sub>	400	450	500	
<b>V<sub>SYS</sub> REGULATION</b>					
V <sub>SYS</sub> Regulated Voltage	$I_{V_{SYS}} = 10mA$	4.45	4.6	4.8	V
<b>nSTAT OUTPUT</b>					
nSTAT Sink current	$V_{nSTAT} = 2V$	4	8	12	mA
nSTAT Leakage Current	$V_{nSTAT} = 4.2V$			1	$\mu A$
<b>ACIN AND CHGLEV INPUTS</b>					
CHGLEV Logic High Input Voltage		1.4			V
CHGLEV Logic Low Input Voltage				0.4	V
CHGLEV Leakage Current	$V_{CHGLEV} = 4.2V$			1	$\mu A$
ACIN Voltage Thresholds	ACIN voltage rising	1.03	1.2	1.31	V
ACIN Hysteresis Voltage	ACIN voltage falling		200		mV
ACIN Leakage Current	$V_{ACIN} = 4.2V$			1	$\mu A$
<b>TH INPUT</b>					
TH Pull-Up Current	$V_{CHGIN} > V_{BAT} + 100mV$ , Hysteresis = 50mV	91	102	110	$\mu A$
V <sub>TH</sub> Upper Temperature Voltage Threshold (V <sub>THH</sub> )	Hot Detect NTC Thermistor	2.44	2.51	2.58	V
V <sub>TH</sub> Lower Temperature Voltage Threshold (V <sub>THL</sub> )	Cold Detect NTC Thermistor	0.47	0.50	0.53	V
V <sub>TH</sub> Hysteresis	Upper and Lower Thresholds		30		mV

## ActivePath™ CHARGER ELECTRICAL CHARACTERISTICS CONT'D

(V<sub>CHGIN</sub> = 5.0V, T<sub>A</sub> = 25°C, unless otherwise specified.)

PARAMETER	TEST CONDITIONS	MIN	TYP	MAX	UNIT	
<b>CHARGER</b>						
BAT Reverse Leakage Current	V <sub>CHGIN</sub> = 0V, V <sub>BAT</sub> = 4.2V, I <sub>VSYS</sub> = 0mA		8		μA	
BAT to VSYS On-Resistance			70		mΩ	
ISET Pin Voltage	Fast Charge		1.2		V	
	Precondition		0.13			
Charge Termination Voltage V <sub>TERM</sub>	T <sub>A</sub> = -20°C to 70°C	4.179	4.2	4.221	V	
	T <sub>A</sub> = -40°C to 85°C	4.170	4.2	4.230		
Charge Current	V <sub>BAT</sub> = 3.8V R <sub>ISET</sub> = 6.8K	ACIN = VSYS, CHGLEV = VSYS	-10%	I <sub>CHG</sub> <sup>①</sup>	+10%	mA
		ACIN = VSYS, CHGLEV = GA	-10%	I <sub>CHG</sub> /5	+10%	
		ACIN = GA, CHGLEV = VSYS	400	450	500	
		ACIN = GA, CHGLEV = GA	80	90	100	
Precondition Charge Current	V <sub>BAT</sub> = 2.7V R <sub>ISET</sub> = 6.8K	ACIN = VSYS, CHGLEV = VSYS	10% I <sub>CHG</sub>		mA	
		ACIN = VSYS, CHGLEV = GA	10% I <sub>CHG</sub>			
		ACIN = GA, CHGLEV = VSYS	45			
		ACIN = GA, CHGLEV = GA	45			
Precondition Threshold Voltage	V <sub>BAT</sub> Voltage Rising	2.75	2.85	3.0	V	
Precondition Threshold Hysteresis	V <sub>BAT</sub> Voltage Falling		150		mV	
END-OF-CHARGE Current Threshold	V <sub>BAT</sub> = 4.15V	ACIN = VSYS, CHGLEV = VSYS	10% I <sub>CHG</sub>		mA	
		ACIN = VSYS, CHGLEV = GA	10% I <sub>CHG</sub>			
		ACIN = GA, CHGLEV = VSYS	45			
		ACIN = GA, CHGLEV = GA	45			
Charge Restart Threshold	V <sub>TERM</sub> - V <sub>BAT</sub> , V <sub>BAT</sub> Falling	190	205	220	mV	
Precondition Safety Timer	PRETIMO[ ] = 10		80		min	
Total Safety Timer	TOTTIMO[ ] = 10		5		hr	
Thermal Regulation Threshold			100		°C	

①: R<sub>ISET</sub> (kΩ) = 2336 × (1V/I<sub>CHG</sub> (mA)) - 0.205

## TYPICAL PERFORMANCE CHARACTERISTICS

( $V_{SYS} = 3.6V$ ,  $T_A = 25^\circ C$ , unless otherwise specified.)

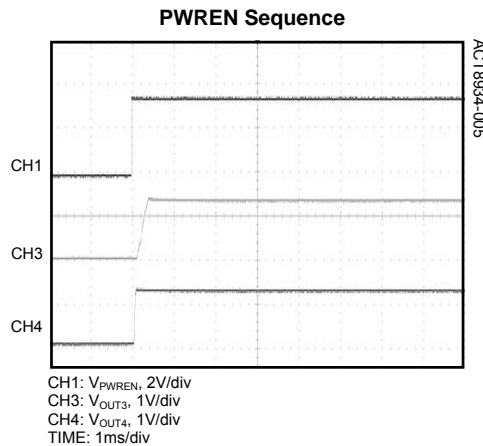
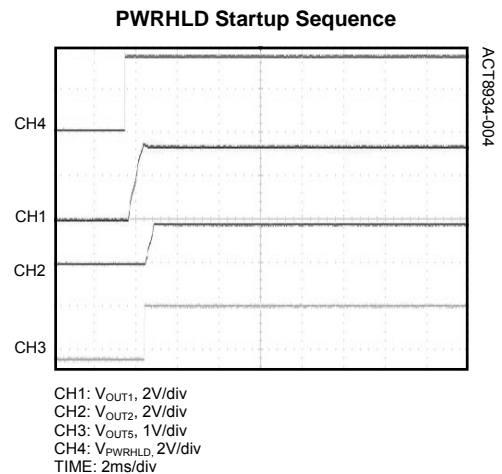
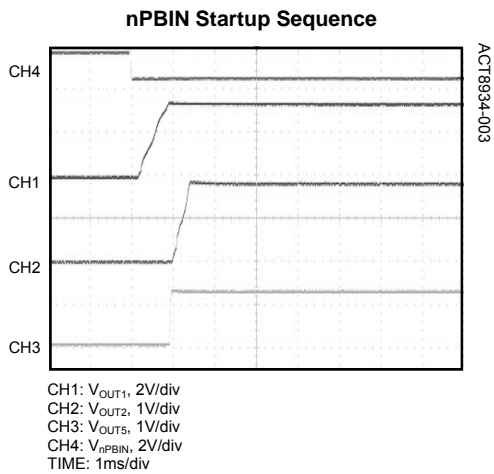
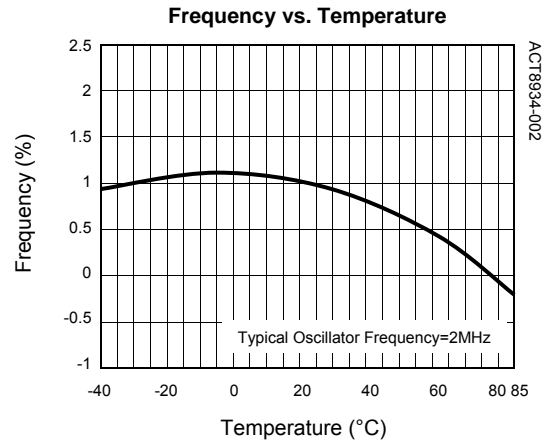
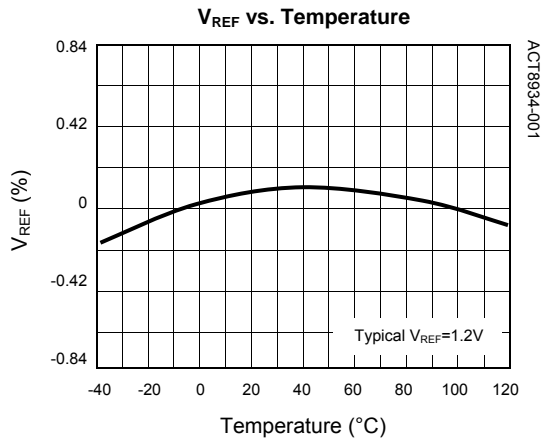

## TYPICAL PERFORMANCE CHARACTERISTICS CONT'D

( $T_A = 25^\circ\text{C}$ , unless otherwise specified.)

**Push-Button Response (First Power-Up)**

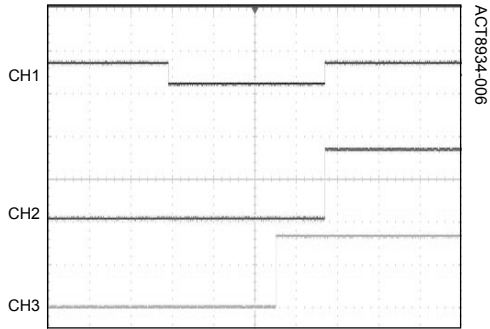

CH1:  $V_{nPBIN}$ , 2V/div  
CH2:  $V_{nPBSTAT}$ , 2V/div  
CH3:  $V_{nRSTO}$ , 2V/div  
TIME: 100ms/div  
nPBIN Resistor = 50kΩ

**Manual Reset Response**

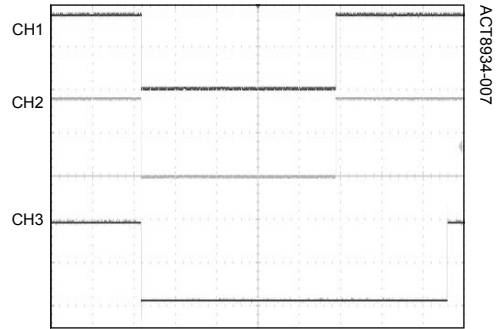

CH1:  $V_{nPBIN}$ , 2V/div  
CH2:  $V_{nPBSTAT}$ , 2V/div  
CH3:  $V_{nRSTO}$ , 2V/div  
TIME: 100ms/div  
nPBIN Resistor = 0Ω

**REG1 Efficiency vs. Output Current**

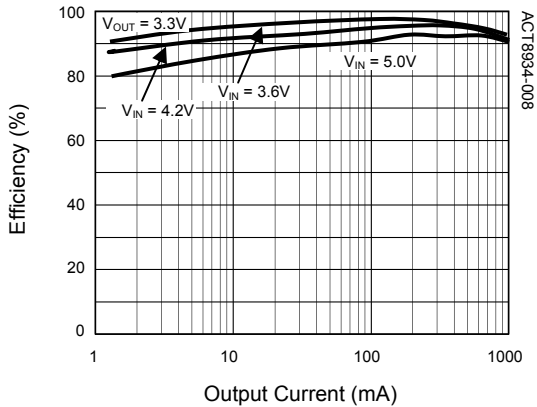

**REG2 Efficiency vs. Output Current**

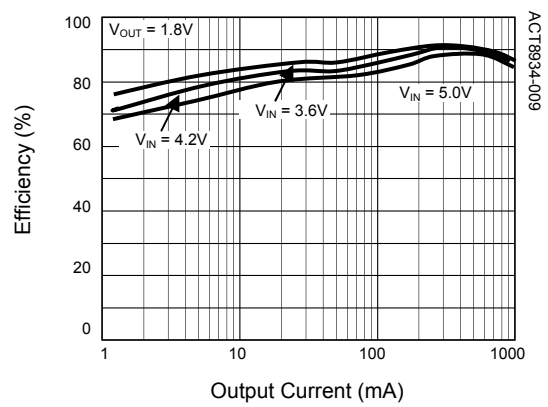

**REG3 Efficiency vs. Output Current**

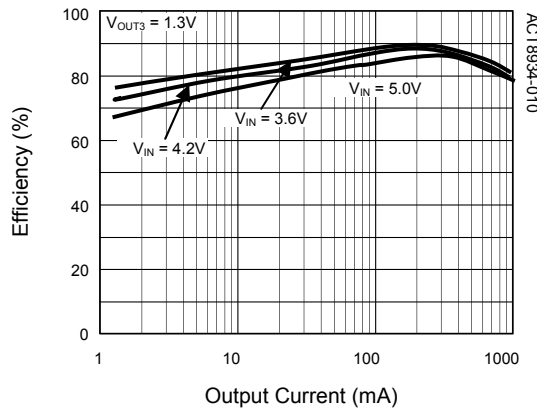

## TYPICAL PERFORMANCE CHARACTERISTICS CONT'D

( $T_A = 25^\circ\text{C}$ , unless otherwise specified.)

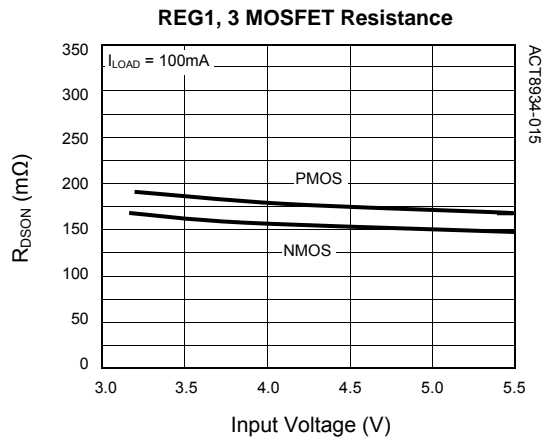
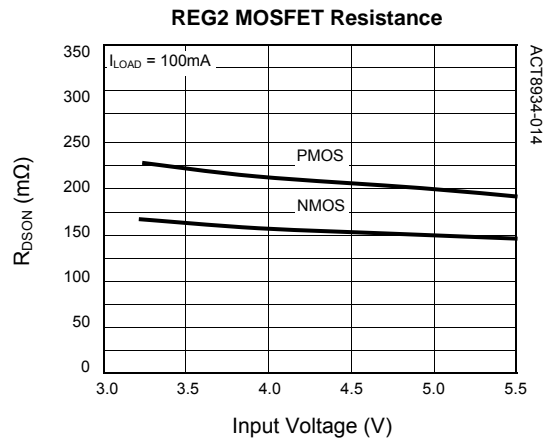
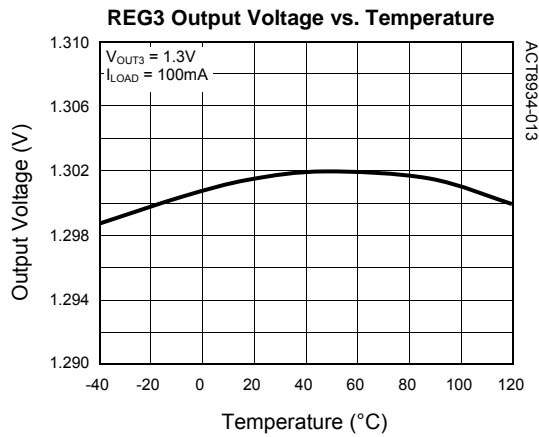
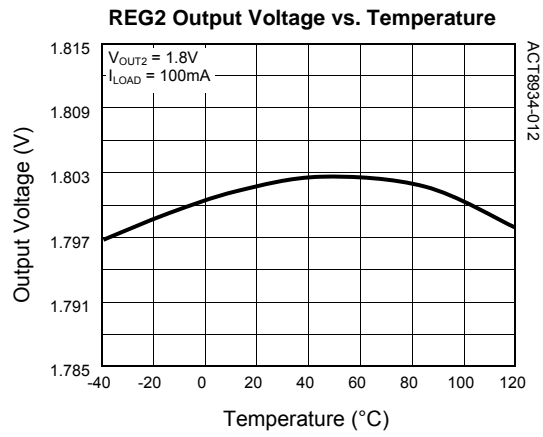
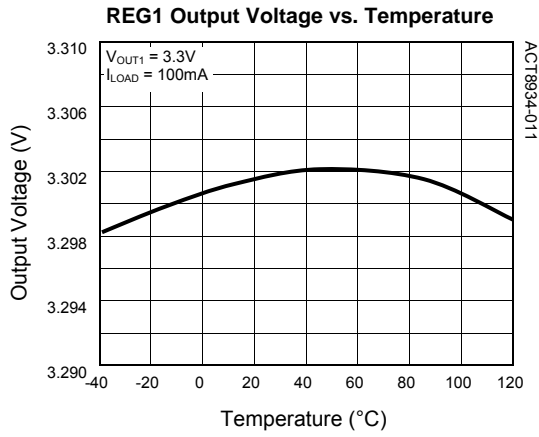

## TYPICAL PERFORMANCE CHARACTERISTICS CONT'D

( $T_A = 25^\circ\text{C}$ , unless otherwise specified.)

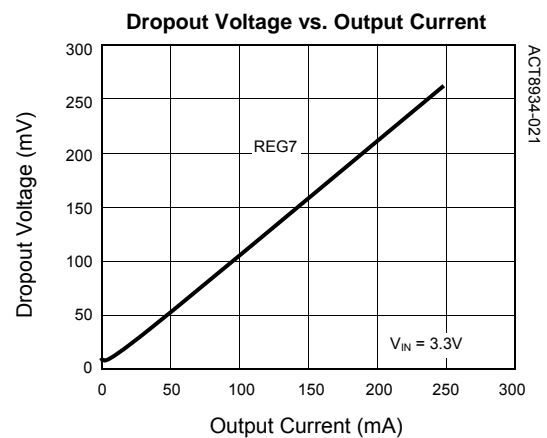
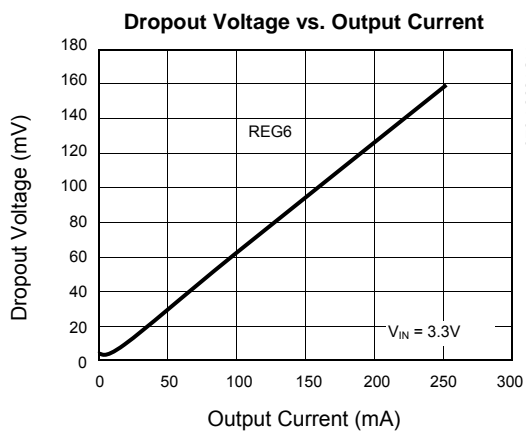
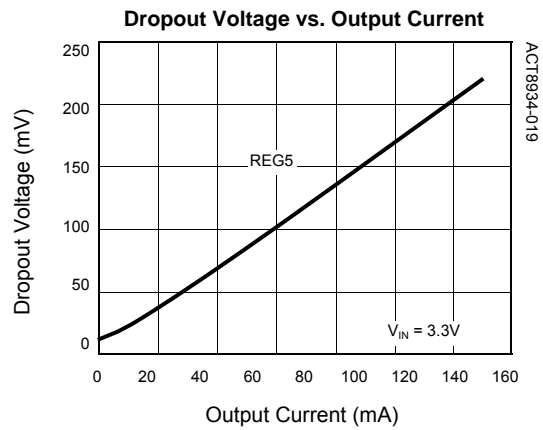
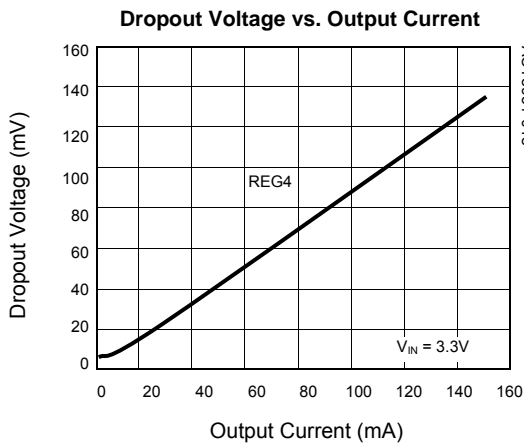
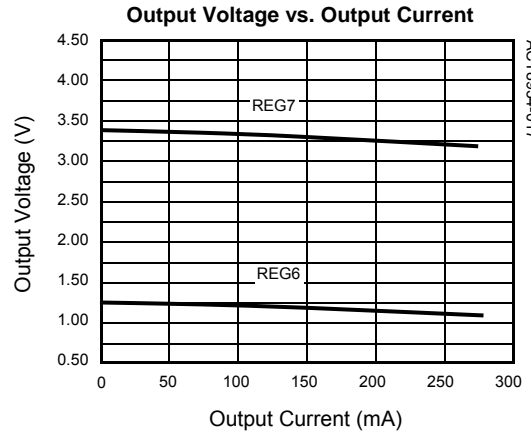
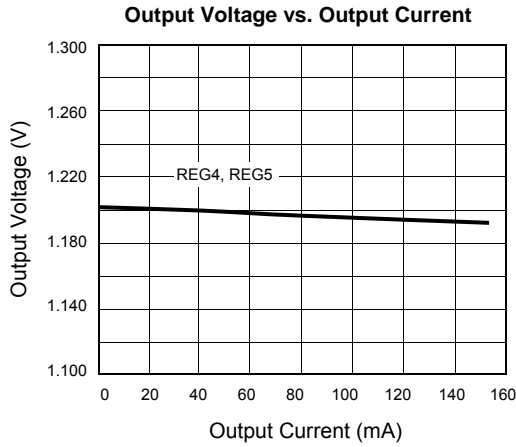

## TYPICAL PERFORMANCE CHARACTERISTICS CONT'D

( $T_A = 25^\circ\text{C}$ , unless otherwise specified.)

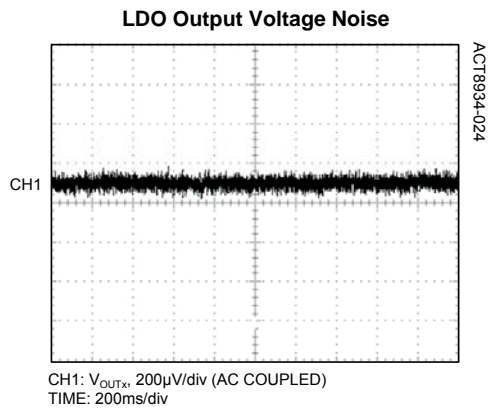
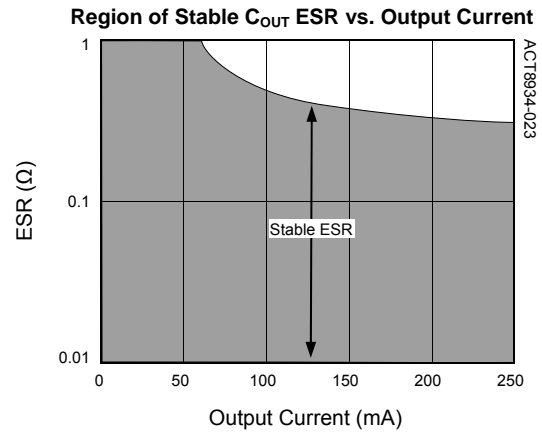
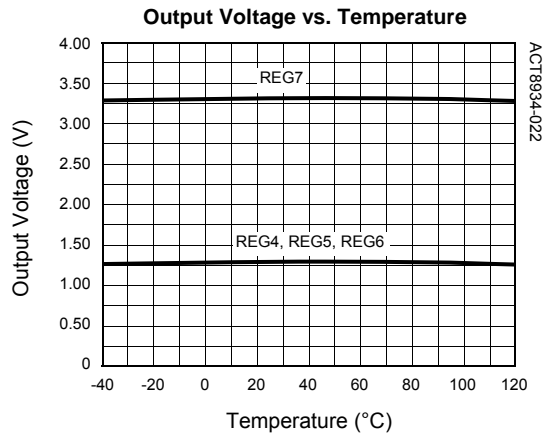



## TYPICAL PERFORMANCE CHARACTERISTICS CONT'D

( $T_A = 25^\circ\text{C}$ , unless otherwise specified.)

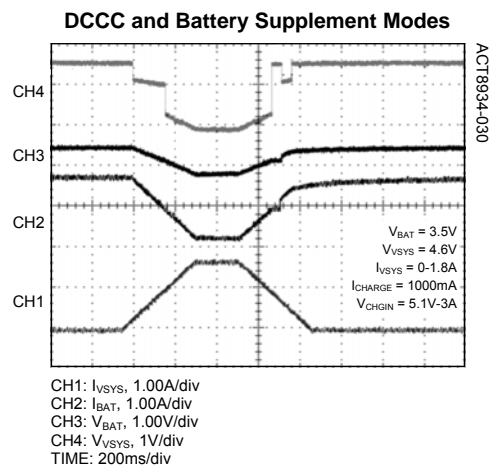
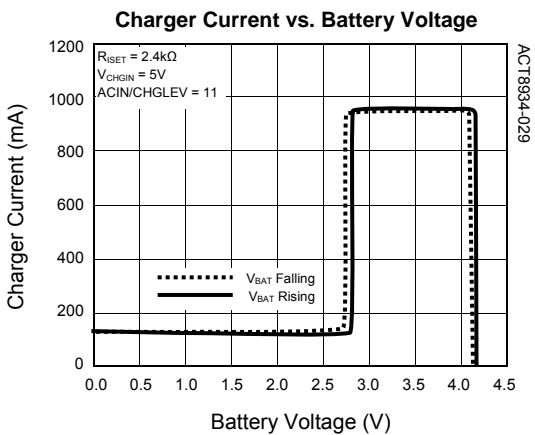
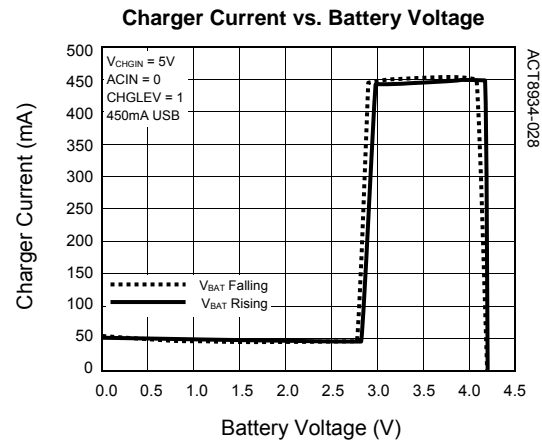
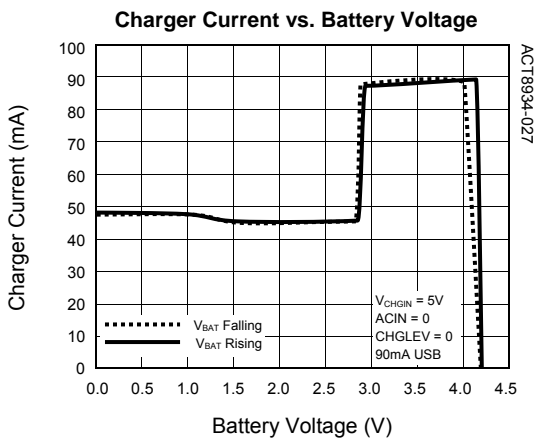
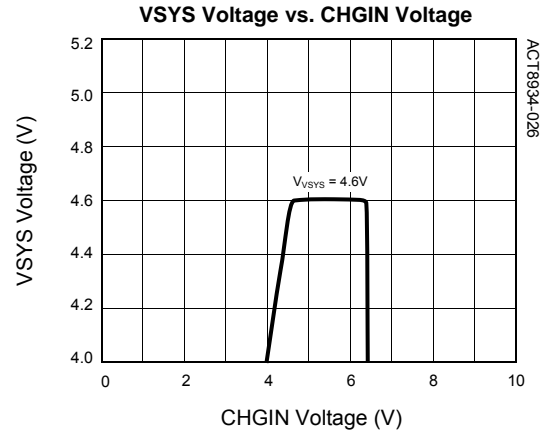
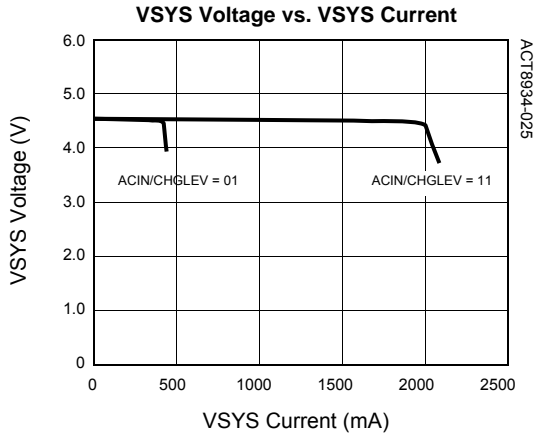

## TYPICAL PERFORMANCE CHARACTERISTICS CONT'D

(T<sub>A</sub> = 25°C, unless otherwise specified.)

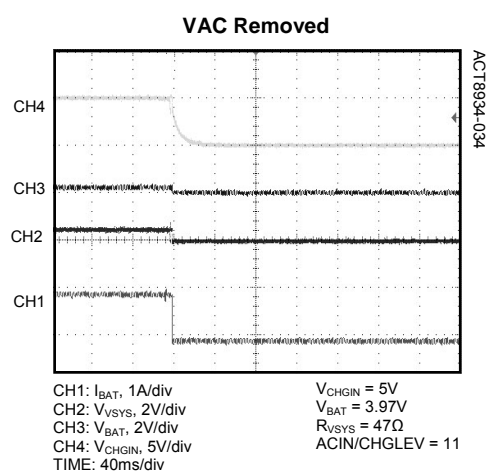
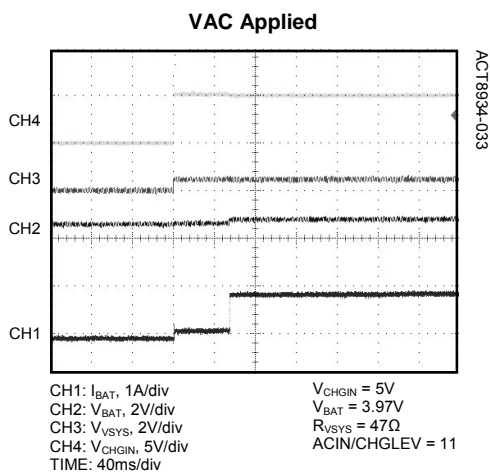
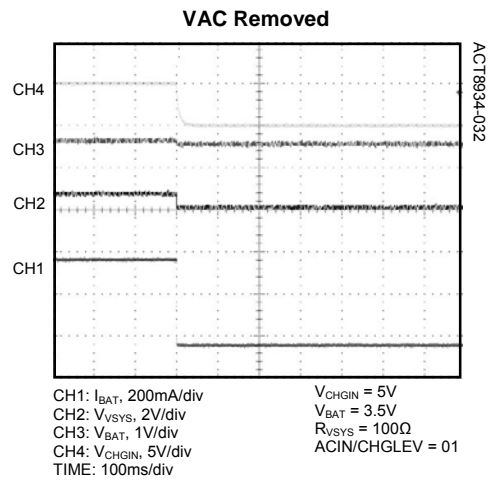
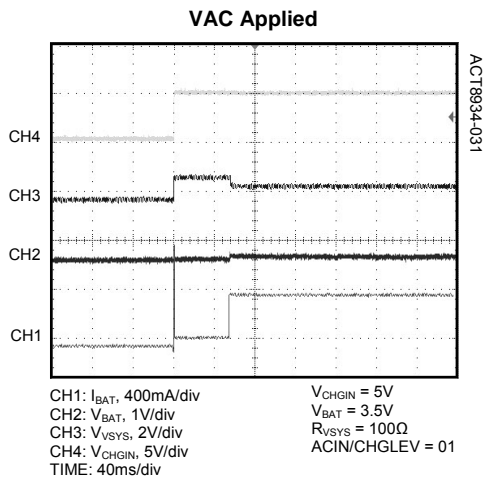

## SYSTEM CONTROL INFORMATION

### Interfacing with the Samsung S3C2416/S3C2450

The ACT8934 is optimized for use in applications using the S3C2416/S3C2450 processor, supporting both the power domains as well as the signal interface for these processors.

While the ACT8934 supports many possible configurations for powering these processors, one of the most common configurations is detailed in this datasheet. In general, this document refers to the ACT8934 pin names and functions. However, in cases where the description of interconnections between these devices benefits by doing so, both

the ACT8934 pin names and the Samsung processor pin names are provided. When this is done, the S3C2416/S3C2450 pin names are located after the ACT8934 pin names, and are italicized and located inside parentheses. For example, PWREN (*PWR\_EN*) refers to the logic signal applied to the ACT8934's PWREN input, identifying that it is driven from the S3C2416/S3C2450's PWR\_EN output. Likewise, OUT1 (VDD\_IO) refers to ACT8934's OUT1 pin, identifying that it is connected to the S3C2416/S3C2450's VDD\_IO power domain.

**Table 2:**  
**ACT8934 and Samsung S3C2416/S3C2450 Power Domains**

POWER DOMAIN	ACT8934 CHANNEL	TYPE	DEFAULT VOLTAGE	CURRENT CAPABILITY
VDD_IO	REG1	DC/DC	3.3V/3.3V	900mA
VDD_MEM	REG2	DC/DC	1.8V/1.8V	700mA
VDD_SRAM				
VDDiarm	REG3	DC/DC	1.3V/1.3V	900mA
VDDi				
VDDA_xPLL	REG4	LDO	1.2V	150mA
VDD_Alive	REG5	LDO	1.2V	150mA
VDDI_UDEV	REG6	LDO	1.2V	250mA
VDDA33x	REG7	LDO	3.3V	250mA

**Table 3:**  
**ACT8934 and Samsung S3C2416/S3C2450 Power Modes**

POWER MODE	CONTROL STATE	POWER DOMAIN STATE	QUIESCENT CURRENT
ALL ON	PWRHLD is asserted, PWREN is asserted, REG6 and REG7 are enabled by I <sup>2</sup> C	REG1, REG2, REG3, REG4, REG5, REG6 and REG7 are all on	420μA
NORMAL	PWRHLD is asserted, PWREN is asserted, REG6 and REG7 are disabled by I <sup>2</sup> C	REG1, REG2, REG3, REG4 and REG5 are on. REG6 and REG7 are off	350μA
SLEEP	PWRHLD is asserted, PWREN is de-asserted, REG6 and REG7 are disabled by I <sup>2</sup> C	REG1, REG2 and REG5 are on. REG3, REG4, REG6 and REG7 are off	250μA
ALL OFF	PWRHLD is de-asserted, PWREN is de-asserted, REG6 and REG7 are disabled by I <sup>2</sup> C	REG1, REG2, REG3, REG4, REG5, REG6 and REG7 are all off	<18μA

**Table 4:**  
**ACT8934 and Samsung S3C2416/S3C2450 Signal Interface**

ACT8934	DIRECTION	SAMSUNG S3C2416/S3C2450
PWREN	←	PWR_EN
SCL	←	IIC_SCL
SDA	↔	IIC_SDA
VSEL	←	DVS_GPIO <sup>①</sup>
nRSTO	→	nRESET
nIRQ	→	EINT0 <sup>②</sup>
nPBSTAT	→	EINT1 <sup>③</sup>
nLBO	→	nBATT_FLT
PWRHLD	←	Power hold GPIO <sup>④</sup>

- ①: Optional connection for DVS control.
- ②, ③: Typical connections shown, actual connections may vary.
- ④: Optional connection for power hold control.

**Table 5:**  
**Control Pins**

PIN NAME	OUTPUT
nPBIN	REG1, REG2, REG5 <sup>①</sup>
PWRHLD	REG1, REG2, REG5 <sup>①</sup>
PWREN	REG3, REG4

## Control Signals

### Enable Inputs

The ACT8934 features a variety of control inputs, which are used to enable and disable outputs depending upon the desired mode of operation. PWREN, PWRHLD are logic inputs, while nPBIN is a unique, multi-function input. Refer to Table 5 for a description of which channels are controlled by each input.

### nPBIN Multi-Function Input

ACT8934 features the nPBIN multi-function pin, which combines system enable/disable control with a hardware reset function. Select either of the two pin functions by asserting this pin, either through a direct connection to GA, or through a 50kΩ resistor to GA, as shown in Figure 2.

### Manual Reset Function

The second major function of the nPBIN input is to provide a manual-reset input for the processor. To manually-reset the processor, drive nPBIN directly to GA through a low impedance (less than 2.5kΩ). When this occurs, nRSTO immediately asserts low, then remains asserted low until the nPBIN input is

de-asserted and the reset time-out period expires.

**Figure 2:**  
**nPBIN Input**

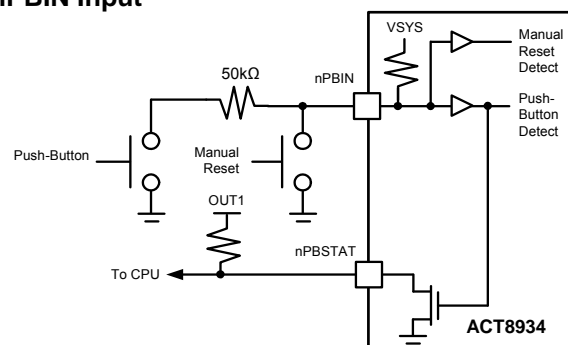

### nPBSTAT Output

nPBSTAT is an open-drain output that reflects the state of the nPBIN input; nPBSTAT is asserted low whenever nPBIN is asserted, and is high-Z otherwise. This output is typically used as an interrupt signal to the processor, to initiate a software-programmable routine such as operating mode selection or to open a menu. Connect nPBSTAT to an appropriate supply voltage (typically OUT1) through a 10kΩ or greater resistor.

①: For ACT8934QJ3XX and ACT8934QJ4XX, asserting nPBIN or PWRHLD also enables REG6 and REG7.

### **nRSTO Output**

nRSTO is an open-drain output which asserts low upon startup or when manual reset is asserted via the nPBIN input. When asserted on startup, nRSTO remains low until reset time-out period expires after OUT1 reaches its power-OK threshold. When asserted due to manual-reset, nRSTO immediately asserts low, then remains asserted low until the nPBIN input is de-asserted and the reset time-out period expires.

Connect a 10kΩ or greater pull-up resistor from nRSTO to an appropriate voltage supply (typically OUT1).

### **nIRQ Output**

nIRQ is an open-drain output that asserts low any time an interrupt is generated. Connect a 10kΩ or greater pull-up resistor from nIRQ to an appropriate voltage supply. nIRQ is typically used to drive the interrupt input of the system processor.

Many of the ACT8934's functions support interrupt-generation as a result of various conditions. These are typically masked by default, but may be unmasked via the I<sup>2</sup>C interface. For more information about the available fault conditions, refer to the appropriate sections of this datasheet.

Note that under some conditions a false interrupt may be generated upon initial startup. For this reason, it is recommended that the interrupt service routine check and validate nSYSLEVMSK[ ] and nFLTMSK[ ] bits before processing an interrupt generated by these bits. These interrupts may be validated by nSYSSTAT[ ], OK[ ] bits.

## **Push-Button Control**

The ACT8934 is designed to initiate a system enable sequence when the nPBIN multi-function input is asserted. Once this occurs, a power-on sequence commences, as described below. The power-on sequence must complete and the microprocessor must take control (by asserting PWREN or PWRHLD) before nPBIN is de-asserted. If the microprocessor is unable to complete its power-up routine successfully before the user releases the push-button, the ACT8934 automatically shuts the system down. This provides protection against accidental or momentary assertions of the push-button. If desired, longer "push-and-hold" times can be implemented by simply adding an additional time delay before asserting PWREN or PWRHLD.

## **Control Sequences**

The ACT8934 features a variety of control

sequences that are optimized for supporting system enable and disable, as well as SLEEP mode of the Samsung S3C2416/S3C2450 processor.

### **Enabling/Disabling Sequence**

A typical enable sequence is initiated whenever the following conditions occurs:

- 1) nPBIN is asserted low via 50KΩ resistance, or
- 2) A valid input voltage is present at CHGIN<sup>①</sup>.

The enable sequence begins by enabling REG1. When REG1 reaches its power-OK threshold, REG2 and REG5<sup>②</sup> are enabled and nRSTO is asserted low, resetting the microprocessor. If REG1 is above its power-OK threshold when the reset timer expires, nRSTO is de-asserted, allowing the microprocessor to begin its boot sequence.

During the boot sequence, the microprocessor must assert PWRHLD, holding REG1, REG2, and REG5<sup>②</sup> and assert PWREN (*PWR\_EN*), enabling REG3 and REG4 to ensure that the system remains powered after nPBIN is released. REG6 and REG7 should be enabled/disabled via I<sup>2</sup>C after microprocessor completes its boot sequence.<sup>②</sup>

Once the power-up routine is completed, the system remains enabled after the push-button is released as long as either PWRHLD or PWREN are asserted high. If the processor does not assert PWRHLD or PWREN before the user releases the push-button, the boot-up sequence is terminated and all regulators are disabled. This provides protection against "false-enable", when the push-button is accidentally depressed, and also ensures that the system remains enabled only if the processor successfully completes the boot-up sequence.

As with the enable sequence, a typical disable sequence is initiated when the user presses the push-button, which interrupts the processor via the nPBSTAT output. The actual disable sequence is completely software-controlled, but typically involved initiating various "clean-up" processes then finally de-assert PWRHLD or set MSTROFF[ ] to 1, disabling REG1, REG2 and REG5<sup>②</sup>, then PWREN should be de-asserted automatically since the processor loses power of VDD\_IO and VDD\_Alive, which disables REG3 and REG4, and shuts the system down.

### **SLEEP Mode Sequence**

The ACT8934 supports Samsung S3C2416/S3C2450 Processors' SLEEP mode operation. Once a successful power-up routine has been completed, SLEEP mode may be initiated

①: Applicable only for ACT8934QJ2XX and ACT8934QJ4XX.

②: For ACT8934QJ3XX and ACT8934QJ4XX, asserting nPBIN or PWRHLD also enables REG6 and REG7.

through a variety of software-controlled mechanisms.

SLEEP mode is typically initiated when the user presses the push-button during normal operation. Pressing the push-button asserts the nPBIN input, which asserts the nPBSTAT output, which interrupts the processor. In response to this interrupt the processor should de-assert PWREN, which disables REG3 and REG4. PWRHLD should remain asserted during SLEEP mode so that REG1, REG2, and REG5<sup>①</sup> remain enabled.

disabling REG3 and REG4. PWRHLD should remain asserted during SLEEP mode so that REG1, REG2, and REG5<sup>①</sup> remain enabled.

Waking from SLEEP mode is initiated when the user presses the push-button again, which asserts nPBSTAT. Processors should respond by asserting PWREN, which enables REG3 and REG4 so that normal operation may resume.

**Figure 3:**  
**Enable/Disable Sequence**

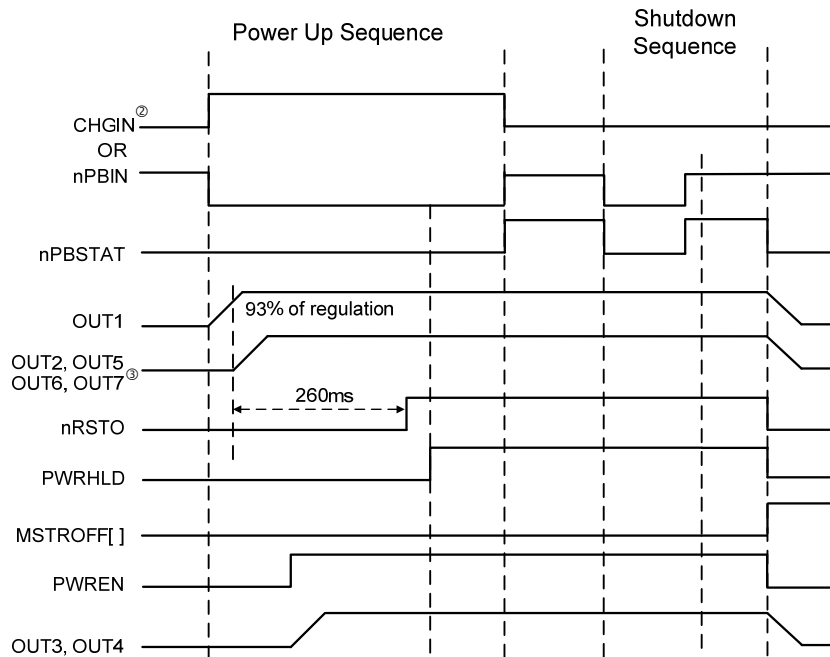

**Figure 4:**  
**Sleep Mode Sequence**

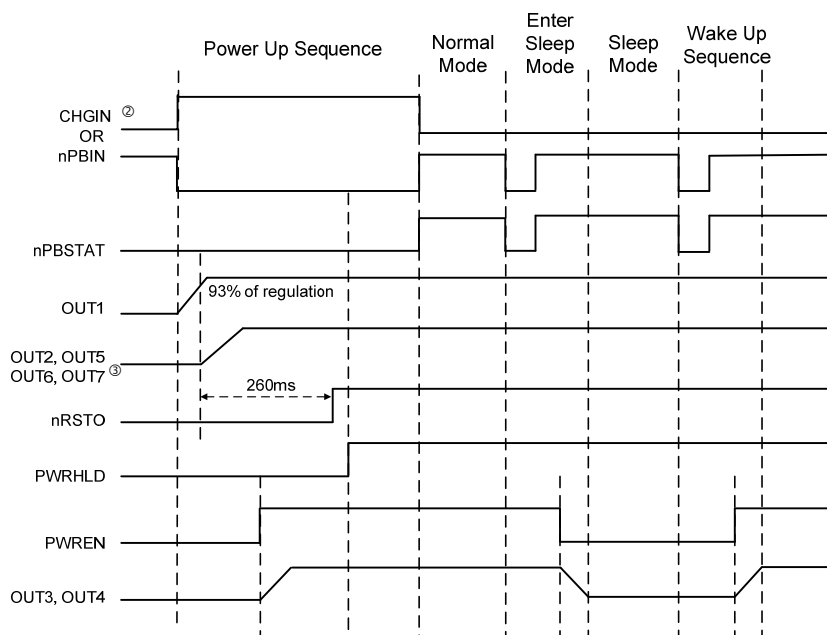

①: For ACT8934QJ3XX and ACT8934QJ4XX, asserting nPBIN or PWRHLD also enables REG6 and REG7.

②: Applicable only for ACT8934QJ2XX and ACT8934QJ4XX.

③: Applicable only for ACT8934QJ3XX and ACT8934QJ4XX.

## FUNCTIONAL DESCRIPTION

### I<sup>2</sup>C Interface

The ACT8934 features an I<sup>2</sup>C interface that allows advanced programming capability to enhance overall system performance. To ensure compatibility with a wide range of system processors, the I<sup>2</sup>C interface supports clock speeds of up to 400kHz (“Fast-Mode” operation) and uses standard I<sup>2</sup>C commands. I<sup>2</sup>C write-byte commands are used to program the ACT8934, and I<sup>2</sup>C read-byte commands are used to read the ACT8934’s internal registers. The ACT8934 always operates as a slave device, and is addressed using a 7-bit slave address followed by an eighth bit, which indicates whether the transaction is a read-operation or a write-operation, [1011011x].

SDA is a bi-directional data line and SCL is a clock input. The master device initiates a transaction by issuing a START condition, defined by SDA transitioning from high to low while SCL is high. Data is transferred in 8-bit packets, beginning with the MSB, and is clocked-in on the rising edge of SCL. Each packet of data is followed by an “Acknowledge” (ACK) bit, used to confirm that the data was transmitted successfully.

For more information regarding the I<sup>2</sup>C 2-wire serial interface, go to the NXP website: <http://www.nxp.com>.

### Voltage Monitor and Interrupt

#### Programmable System Voltage Monitor

The ACT8934 features a programmable system-voltage monitor, which monitors the voltage at VSYS and compares it to a programmable threshold voltage. The programmable voltage threshold is programmed by SYSLEV[3:0], as shown in Table 6.

SYSLEV[ ] is set to 3.0V by default. There is a 200mV rising hysteresis on SYSLEV[ ] threshold such that V<sub>VSYS</sub> needs to be 3.2V(typ) or higher in order to power up the IC.

The nSYSSTAT[ ] bit reflects the output of an internal voltage comparator that monitors V<sub>VSYS</sub> relative to the SYSLEV[ ] voltage threshold, the value of nSYSSTAT[ ] = 1 when V<sub>VSYS</sub> is lower than the SYSLEV[ ] voltage threshold, and nSYSSTAT[ ] = 0 when V<sub>VSYS</sub> is higher than the SYSLEV[ ] voltage threshold. Note that the SYSLEV[ ] voltage threshold is defined for falling voltages, and that the comparator produces about 200mV of hysteresis at VSYS. As a result, once V<sub>VSYS</sub> falls below the SYSLEV threshold, its voltage must increase by more than about 200mV to clear that condition.

After the IC is powered up, the ACT8934 responds in one of two ways when the voltage at VSYS falls below the SYSLEV[ ] voltage threshold:

1) If nSYSMODE[ ] = 1 (default case), when system voltage level interrupt is unmasked (nSYSLEVMSK[ ]=1) and V<sub>VSYS</sub> falls below the programmable threshold, the ACT8934 asserts nIRQ, providing a software “under-voltage alarm”. The response to this interrupt is controlled by the CPU, but will typically initiate a controlled shutdown sequence either or alert the user that the battery is low. In this case the interrupt is cleared when V<sub>VSYS</sub> rises up again above the SYSLEV rising threshold and nSYSSTAT[ ] is read via I<sup>2</sup>C.

2) If nSYSMODE[ ] = 0, when V<sub>VSYS</sub> falls below the programmable threshold the ACT8934 shuts down, immediately disabling all regulators. This option is useful for implementing a programmable “under-voltage lockout” function that forces the system off when the battery voltage falls below the SYSLEV threshold voltage. Since this option does not support a controlled shutdown sequence, it is generally used as a “fail-safe” to shut the system down when the battery voltage is too low.

Table 6:

SYSLEV Falling Threshold

SYSLEV[3:0]	SYSLEV Falling Threshold (Hysteresis = 200mV)
0000	2.3
0001	2.4
0010	2.5
0011	2.6
0100	2.7
0101	2.8
0110	2.9
0111	3.0
1000	3.1
1001	3.2
1010	3.3
1011	3.4
1100	3.5
1101	3.6
1110	3.7
1111	3.8

#### Precision Voltage Detector

The LBI input connects to one input of a precision voltage comparator, which can be used to monitor a system voltage such as the battery voltage. An external resistive-divider network can be used to set voltage monitoring thresholds, as shown in *Functional Block Diagram*. The output of the comparator is present at the nLBO open-drain output.

## Thermal Shutdown

The ACT8934 integrates thermal shutdown protection circuitry to prevent damage resulting from excessive thermal stress, as may be encountered under fault conditions. This circuitry disables all regulators if the ACT8934 die temperature exceeds 160°C, and prevents the regulators from being enabled until the IC temperature drops by 20°C (typ).



## STEP-DOWN DC/DC REGULATORS

### General Description

The ACT8934 features three synchronous, fixed-frequency, current-mode PWM step down converters that achieve peak efficiencies of up to 97%. REG1 and REG3 are capable of supplying up to 900mA of output current, while REG2 supports up to 700mA. These regulators operate with a fixed frequency of 2MHz, minimizing noise in sensitive applications and allowing the use of small external components.

### 100% Duty Cycle Operation

Each regulator is capable of operating at up to 100% duty cycle. During 100% duty-cycle operation, the high-side power MOSFET is held on continuously, providing a direct connection from the input to the output (through the inductor), ensuring the lowest possible dropout voltage in battery powered applications.

### Synchronous Rectification

REG1, REG2, and REG3 each feature integrated n-channel synchronous rectifiers, maximizing efficiency and minimizing the total solution size and cost by eliminating the need for external rectifiers.

### Soft-Start

When enabled, each output voltages tracks an internal 400 $\mu$ s soft-start ramp, minimizing input current during startup and allowing each regulator to power up in a smooth, monotonic manner that is independent of output load conditions.

### Compensation

Each buck regulator utilizes current-mode control and a proprietary internal compensation scheme to simultaneously simplify external component selection and optimize transient performance over its full operating range. No compensation design is required; simply follow a few simple guidelines described below when choosing external components.

#### *Input Capacitor Selection*

The input capacitor reduces peak currents and noise induced upon the voltage source. A 4.7 $\mu$ F ceramic capacitor is recommended for each regulator in most applications.

#### *Output Capacitor Selection*

For most applications, 22 $\mu$ F ceramic output capacitors are recommended for REG1 and REG3, while 15 $\mu$ F ceramic output capacitor is recommended for REG2.

Despite the advantages of ceramic capacitors, care

must be taken during the design process to ensure stable operation over the full operating voltage and temperature range. Ceramic capacitors are available in a variety of dielectrics, each of which exhibits different characteristics that can greatly affect performance over their temperature and voltage ranges.

Two of the most common dielectrics are Y5V and X5R. Whereas Y5V dielectrics are inexpensive and can provide high capacitance in small packages, their capacitance varies greatly over their voltage and temperature ranges and are not recommended for DC/DC applications. X5R and X7R dielectrics are more suitable for output capacitor applications, as their characteristics are more stable over their operating ranges, and are highly recommended.

#### *Inductor Selection*

REG1, REG2, and REG3 utilize current-mode control and a proprietary internal compensation scheme to simultaneously simplify external component selection and optimize transient performance over their full operating range. These devices were optimized for operation with 2.2 $\mu$ H inductors, although inductors in the 1.5 $\mu$ H to 3.3 $\mu$ H range can be used. Choose an inductor with a low DC-resistance, and avoid inductor saturation by choosing inductors with DC ratings that exceed the maximum output current by at least 30%.

### Configuration Options

#### *Output Voltage Programming*

By default, each regulator powers up and regulates to its default output voltage. Output voltage is selectable by setting VSEL pin that when VSEL is low, output voltage is programmed by VSET1[ ] bits, and when VSEL is high, output voltage is programmed by VSET2[ ] bits. However, once the system is enabled, each regulator's output voltage may be independently programmed to a different value, typically in order to minimize the power consumption of the microprocessor during some operating modes. Program the output voltages via the I<sup>2</sup>C serial interface by writing to the regulator's VSET1[ ] register if VSEL is low or VSET2[ ] register if VSEL is high as shown in Table 8.

#### *Enable / Disable Control*

During normal operation, each buck may be enabled or disabled via the I<sup>2</sup>C interface by writing to that regulator's ON[ ] bit. The regulator accept rising or falling edge of ON[ ] bit as on/off signal. To enable the regulator, clear ON[ ] to 0 first then set to 1. To disable the regulator, set ON[ ] to 1 first then clear it to 0.

### REG1, REG2, REG3 Turn-on Delay

Each of REG1, REG2 and REG3 features a programmable Turn-on Delay which help ensure a reliable qualification. This delay is programmed by DELAY[2:0], as shown in Table 7.

**Table 7:**

**REGx/DELAY[ ] Turn-On Delay**

DELAY[2]	DELAY[1]	DELAY[0]	TURN-ON DELAY
0	0	0	0 ms
0	0	1	2 ms
0	1	0	4 ms
0	1	1	8 ms
1	0	0	16 ms
1	0	1	32 ms
1	1	0	64 ms
1	1	1	128 ms

### Operating Mode

By default, REG1, REG2, and REG3 each operate in fixed-frequency PWM mode at medium to heavy loads, while automatically transitioning to a proprietary power-saving mode at light loads in order to maximize standby battery life. In applications where low noise is critical, force fixed-frequency PWM operation across the entire load current range, at the expense of light-load efficiency, by setting the MODE[ ] bit to 1.

### OK[ ] and Output Fault Interrupt

Each DC/DC features a power-OK status bit that can be read by the system microprocessor via the I<sup>2</sup>C interface. If an output voltage is lower than the power-OK threshold, typically 7% below the

programmed regulation voltage, that regulator's OK[ ] bit will be 0.

If a DC/DC's nFLTMSK[ ] bit is set to 1, the ACT8934 will interrupt the processor if that DC/DC's output voltage falls below the power-OK threshold. In this case, nIRQ will assert low and remain asserted until either the regulator is turned off or back in regulation, and the OK[ ] bit has been read via I<sup>2</sup>C.

### PCB Layout Considerations

High switching frequencies and large peak currents make PC board layout an important part of step-down DC/DC converter design. A good design minimizes excessive EMI on the feedback paths and voltage gradients in the ground plane, both of which can result in instability or regulation errors.

Step-down DC/DCs exhibit discontinuous input current, so the input capacitors should be placed as close as possible to the IC, and avoiding the use of via if possible. The inductor, input filter capacitor, and output filter capacitor should be connected as close together as possible, with short, direct, and wide traces. The ground nodes for each regulator's power loop should be connected at a single point in a star-ground configuration, and this point should be connected to the backside ground plane with multiple via. The output node for each regulator should be connected to its corresponding OUTx pin through the shortest possible route, while keeping sufficient distance from switching nodes to prevent noise injection. Finally, the exposed pad should be directly connected to the backside ground plane using multiple via to achieve low electrical and thermal resistance.

**Table 8:**

**REGx/VSET[ ] Output Voltage Setting**

REGx/VSET[2:0]	REGx/VSET[5:3]							
	000	001	010	011	100	101	110	111
000	0.600	0.800	1.000	1.200	1.600	2.000	2.400	3.200
001	0.625	0.825	1.025	1.250	1.650	2.050	2.500	3.300
010	0.650	0.850	1.050	1.300	1.700	2.100	2.600	3.400
011	0.675	0.875	1.075	1.350	1.750	2.150	2.700	3.500
100	0.700	0.900	1.100	1.400	1.800	2.200	2.800	3.600
101	0.725	0.925	1.125	1.450	1.850	2.250	2.900	3.700
110	0.750	0.950	1.150	1.500	1.900	2.300	3.000	3.800
111	0.775	0.975	1.175	1.550	1.950	2.350	3.100	3.900

## LOW-NOISE, LOW-DROPOUT LINEAR REGULATORS

### General Description

REG4, REG5, REG6, and REG7 are low-noise, low-dropout linear regulators (LDOs) that supply up to 150mA, 150mA, 250mA, and 250mA, respectively. Each LDO has been optimized to achieve low noise and high-PSRR, achieving more than 65dB PSRR at frequencies up to 10kHz.

### Output Current Limit

Each LDO contains current-limit circuitry featuring a current-limit fold-back function. During normal and moderate overload conditions, the regulators can support more than their rated output currents. During extreme overload conditions, however, the current limit is reduced by approximately 30%, reducing power dissipation within the IC.

### Compensation

The LDOs are internally compensated and require very little design effort, simply select input and output capacitors according to the guidelines below.

#### *Input Capacitor Selection*

Each LDO requires a small ceramic input capacitor to supply current to support fast transients at the input of the LDO. Bypassing each INL pin to GA with 1 $\mu$ F. High quality ceramic capacitors such as X7R and X5R dielectric types are strongly recommended.

#### *Output Capacitor Selection*

Each LDO requires a small ceramic output capacitor for stability. Capacitance value is 1.5 $\mu$ F for REG4 and REG5, 2.2 $\mu$ F for REG6 and REG7. For best performance, each output capacitor should be connected directly between the output and GA pins, as close to the output as possible, and with a short, direct connection. High quality ceramic capacitors such as X7R and X5R dielectric types are strongly recommended.

### Configuration Options

#### *Output Voltage Programming*

By default, each LDO powers up and regulates to its default output voltage. Once the system is enabled, each output voltage may be independently programmed to a different value by writing to the regulator's VSET[ ] register via the I<sup>2</sup>C serial interface as shown in Table 8.

#### *Enable / Disable Control*

During normal operation, each LDO may be enabled or disabled via the I<sup>2</sup>C interface by writing to that LDO's ON[ ] bit. The regulator accept rising

or falling edge of ON[ ] bit as on/off signal. To enable the regulator, clear ON[ ] to 0 first then set to 1. To disable the regulator, set ON[ ] to 1 first then clear it to 0.

#### *REG4, REG5, REG6, REG7 Turn-on Delay*

Each of REG4, REG5, REG6 and REG7 features a programmable Turn-on Delay which help ensure a reliable qualification. This delay is programmed by DELAY[2:0], as shown in Table 7.

#### *Output Discharge*

Each of the ACT8934's LDOs features an optional output discharge function, which discharges the output to ground through a 1.5k $\Omega$  resistance when the LDO is disabled. This feature may be enabled or disabled by setting DIS[ ]; set DIS[ ] to 1 to enable this function, clear DIS[ ] to 0 to disable it.

#### *Low-Power Mode*

Each of ACT8934's LDOs features a LOWIQ[ ] bit which, when set to 1, reduces the LDO's quiescent current by about 16%, saving power and extending battery lifetime.

### OK[ ] and Output Fault Interrupt

Each LDO features a power-OK status bit that can be read by the system microprocessor via the interface. If an output voltage is lower than the power-OK threshold, typically 11% below the programmed regulation voltage, the value of that regulator's OK[ ] bit will be 0.

If a LDO's nFLTMSK[ ] bit is set to 1, the ACT8934 will interrupt the processor if that LDO's output voltage falls below the power-OK threshold. In this case, nIRQ will assert low and remain asserted until either the regulator is turned off or back in regulation, and the OK[ ] bit has been read via I<sup>2</sup>C.

### PCB Layout Considerations

The ACT8934's LDOs provide good DC, AC, and noise performance over a wide range of operating conditions, and are relatively insensitive to layout considerations. When designing a PCB, however, careful layout is necessary to prevent other circuitry from degrading LDO performance.

A good design places input and output capacitors as close to the LDO inputs and output as possible, and utilizes a star-ground configuration for all regulators to prevent noise-coupling through ground. Output traces should be routed to avoid close proximity to noisy nodes, particularly the SW nodes of the DC/DCs.

REFBP is a noise-filtered reference, and internally

has a direct connection to the linear regulator controller. Any noise injected into REFBP will directly affect the outputs of the linear regulators, and therefore special care should be taken to ensure that no noise is injected to the outputs via REFBP. As with the LDO output capacitors, the REFBP bypass capacitor should be placed as close to the IC as possible, with short, direct connections to the star-ground. Avoid the use of via whenever possible. Noisy nodes, such as from the DC/DCs, should be routed as far away from REFBP as possible.

## ActivePath™ CHARGER

### General Description

The ACT8934 features an advanced battery charger that incorporates the patent-pending *ActivePath architecture for system power selection*. This combination of circuits provides a complete, advanced battery-management system that automatically selects the best available input supply, manages charge current to ensure system power availability, and provides a complete, high-accuracy ( $\pm 0.5\%$ ), thermally regulated, full-featured single-cell linear Li+ charger that can withstand input voltages of up to 12V.

### ActivePath Architecture

The *ActivePath* architecture performs three important functions:

- 1) System Configuration Optimization
- 2) Input Protection
- 3) Battery-Management

### System Configuration Optimization

The *ActivePath* circuitry monitors the state of the input supply, the battery, and the system, and automatically reconfigures itself to optimize the power system. If a valid input supply is present, *ActivePath* powers the system from the input while charging the battery in parallel. This allows the battery to charge as quickly as possible, while supplying the system. If a valid input supply is not present, *ActivePath* powers the system from the battery. Finally, if the input is present and the system current requirement exceeds the capability of the input supply, *ActivePath* allows system power to be drawn from both the battery and the input supply.

### Input Protection

#### Input Over-Voltage Protection

The *ActivePath* circuitry features input over-voltage protection circuitry. This circuitry disables charging when the input voltage exceeds the voltage set by OVPSET[ ] as shown in Table 9, but stands off the input voltage in order to protect the system. Note that the adjustable OVP threshold is intended to provide the charge cycle with adjustable immunity against upward voltage transients on the input, and is not intended to allow continuous charging with input voltages above the charger's normal operating voltage range. Independent of the OVPSET[ ] setting, the charge cycle is not allowed to resume until the input voltage falls back into the charger's normal operating voltage range (i.e. below 6.0V).

In an input over-voltage condition this circuit limits  $V_{VSYS}$  to 4.6V, protecting any circuitry connected to VSYS from the over-voltage condition, which may exceed this circuitry's voltage capability. This circuit is capable of withstanding input voltages of up to 12V.

Table 9:

Input Over-Voltage Protection Setting

OVPSET[1]	OVPSET[0]	OVP THRESHOLD
0	0	6.6V
0	1	7.0V
1	0	7.5V
1	1	8.0V

#### Input Supply Overload Protection

The *ActivePath* circuitry monitors and limits the total current drawn from the input supply to a value set by the ACIN and CHGLEV inputs, as well as the resistor connected to ISET. Drive ACIN to a logic-low for "USB Mode", which limits the input current to either 100mA, when CHGLEV is driven to a logic-low, or 450mA, when CHGLEV is driven to a logic-high. Drive ACIN to a logic-high for "AC-Mode", which limits the input current to 2A, typically.

#### Input Under Voltage Lockout

If the input voltage applied to CHGIN falls below 3.5V (typ), an input under-voltage condition is detected and the charger is disabled. Once an input under-voltage condition is detected, a new charge cycle will initiate when the input exceeds the under-voltage threshold by at least 500mV.

### Battery Management

The ACT8934 features a full-featured, intelligent charger for Lithium-based cells, and was designed specifically to provide a complete charging solution with minimum system design effort.

The core of the charger is a CC/CV (Constant-Current/Constant-Voltage), linear-mode charge controller. This controller incorporates current and voltage sense circuitry, an internal 70mΩ power MOSFET, thermal-regulation circuitry, a full-featured state machine that implements charge control and safety features, and circuitry that eliminates the reverse blocking diode required by conventional charger designs.

The charge termination voltage is highly accurate ( $\pm 0.5\%$ ), and features a selection of charge safety time-out periods that protect the system from operation with damaged cells. Other features

include pin-programmable fast-charge current and one current-limited nSTAT output that can directly drive LED indicator or provide a logic-level status signal to the host microprocessor.

### Dynamic Charge Current Control (DCCC)

The ACT8934's *ActivePath* charger features dynamic charge current control (DCCC) circuitry, which acts to ensure that the system remains powered while operating within the maximum output capability of the power adapter. The DCCC circuitry continuously monitors  $V_{VSYS}$ , and if the voltage at VSYS drops by more than 200mV, the DCCC circuitry automatically reduces charge current in order to prevent  $V_{VSYS}$  from continuing to drop.

### Charge Current Programming

The ACT8934's *ActivePath* charger features a flexible charge current-programming scheme that combines the convenience of internal charge current programming with the flexibility of resistor based charge current programming. Current limits and charge current programming are managed as a function of the ACIN and CHGLEV pins, in combination with  $R_{ISET}$ , the resistance connected to the ISET pin.

ACIN is a logic input that configures the current-limit of *ActivePath*'s linear regulator as well as that of the battery charger. ACIN features a precise 1.2V logic threshold, so that the input voltage detection threshold may be adjusted with a simple resistive voltage divider. This input also allows a simple, low-cost dual-input charger switch to be implemented with just a few, low-cost components.

When the voltage at ACIN is above the 1.2V threshold, the charger operates in "AC-Mode" with a charge current programmed by  $R_{ISET}$ , and the  $R_{ISET}$  is given by:

$$R_{ISET} \text{ (k}\Omega\text{)} = 2336 \times (1V/I_{CHG} \text{ (mA)}) - 0.205$$

With a given  $R_{ISET}$  then charge current will reduce 5 times when CHGLEV is driven low.

When ACIN is below the 1.2V threshold, the charger operates in "USB-Mode", with a maximum CHGIN input current and charge current defined by the CHGLEV input; 450mA, if CHGLEV is driven to

a logic-high, or 100mA, if CHGLEV is driven to a logic-low.

The ACT8934's charge current settings are summarized in Table 10.

Note that the actual charge current may be limited to a current lower than the programmed fast charge current due to the ACT8934's internal thermal regulation loop. See the *Thermal Regulation* section for more information.

### Charger Input Interrupts

In order to ease input supply detection and eliminate the size and cost of external detection circuitry, the charger has the ability to generate interrupts based upon the status of the input supply. This function is capable of generating an interrupt when the input is connected, disconnected, or both. An interrupt is generated any time the input supply is connected when INSTAT[ ] bit is set to 1 and the INCON[ ] bit is set to 1, and an interrupt is generated any time the input supply is disconnected when INSTAT[ ] bit is set to 1 and the INDIS[ ] bit is set to 1.

INDAT[ ] indicates the status of the CHGIN input supply. A value of 1 indicates that a valid CHGIN input ( $CHGIN \text{ UVLO Threshold} < V_{CHGIN} < CHGIN \text{ OVP Threshold}$ ) is present, a value of 0 indicates a valid input is not present.

When an interrupt is generated by the input supply, reading the INSTAT[ ] returns a value of 1. INSTAT[ ] is automatically cleared to 0 upon reading. When no interrupt is generated by the input supply, reading the INSTAT[ ] returns a value of 0.

When responding to an Input Status Interrupt, it is often useful to know the state of the ACIN input. For example, in a dual-input charger application knowing the state of the ACIN input can identify which type of input supply has been connected. The state of the ACIN input can be read at any time by reading the ACINSTAT[ ] bit, where a value of 1 indicates that the voltage at ACIN is above the 1.2V threshold (indicating that a wall-cube has been attached), and a value of 0 indicates that the voltage is below this threshold (indicating that ACIN input is not valid and USB supply input is selected).

Table 10:

ACIN and CHGLEV Inputs

ACIN	CHGLEV	CHARGE CURRENT (mA)	PRECONDITION CHARGE CURRENT (mA)
0	0	90	45
0	1	450	45
1	0	$I_{CHG}/5$	$10\% \times I_{CHG}$
1	1	$I_{CHG}$	$10\% \times I_{CHG}$

**Figure 5:**  
Typical Li+ charge profile and ACT8934 charge states

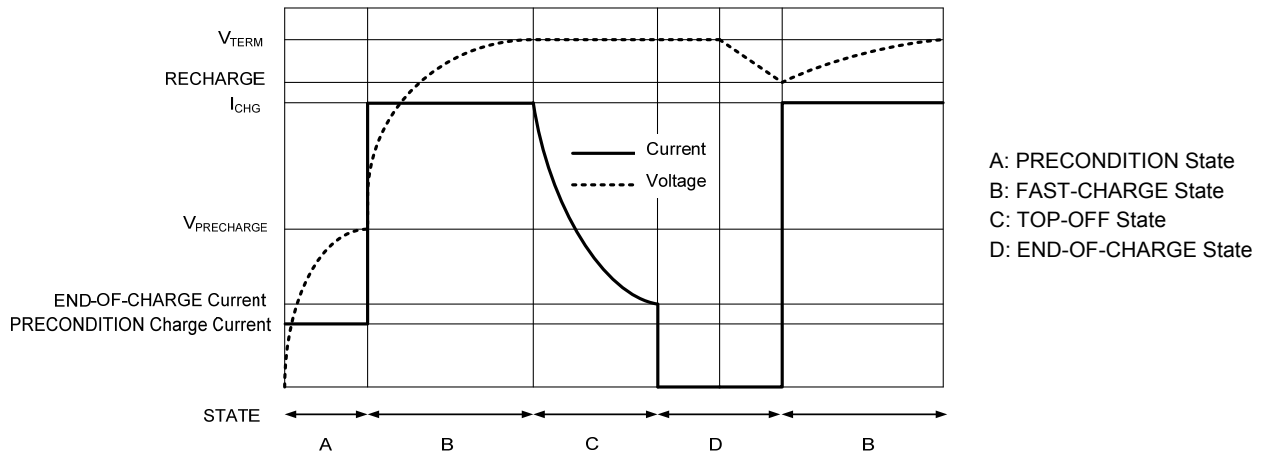

**Figure 6:**  
Charger State Diagram

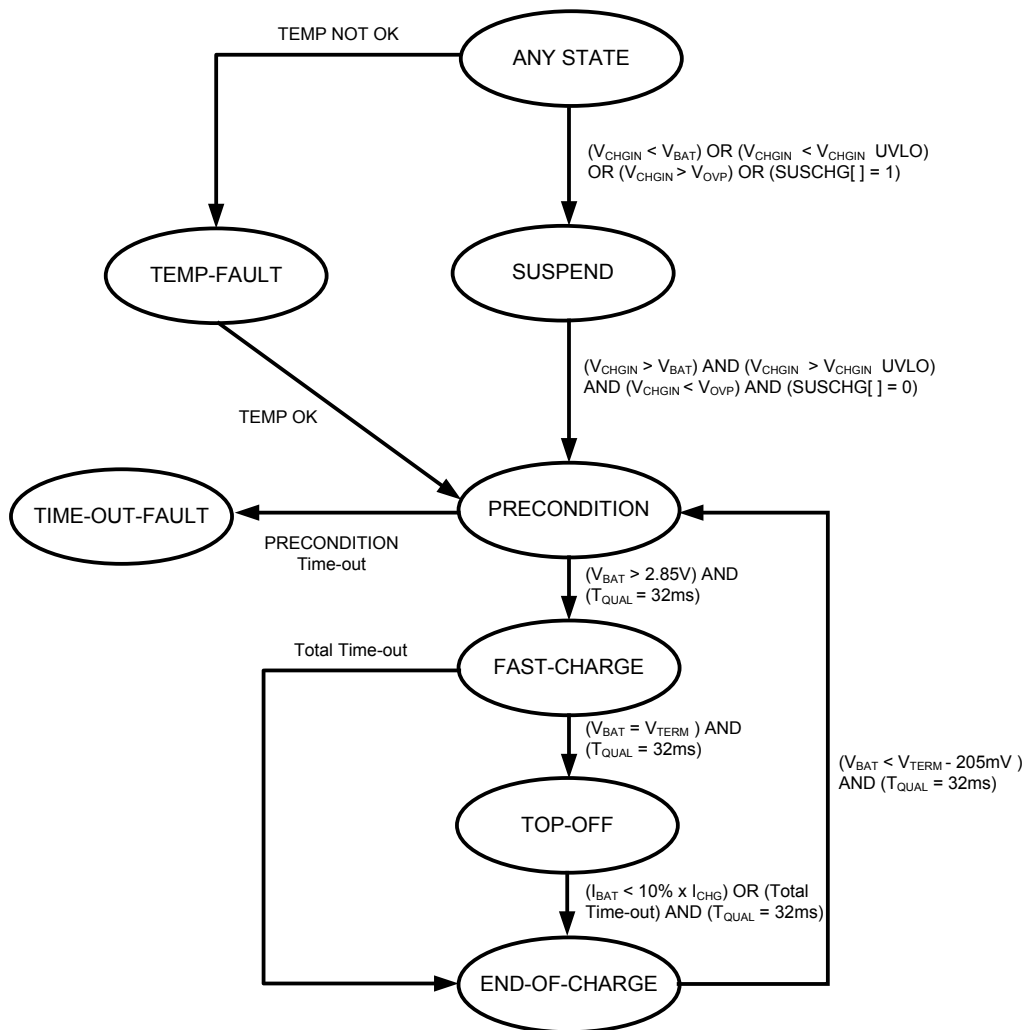

## Charge-Control State Machine

### PRECONDITION State

A new charging cycle begins with the PRECONDITION state, and operation continues in this state until  $V_{BAT}$  exceeds the Precondition Threshold Voltage. When operating in PRECONDITION state, the cell is charged at 10% of the programmed maximum fast-charge constant current,  $I_{CHG}$ .

Once  $V_{BAT}$  reaches the Precondition Threshold Voltage, the state machine jumps to the FAST-CHARGE state. If  $V_{BAT}$  does not reach the Precondition Threshold Voltage before the Precondition Time-out period expires, then the state machine jumps to the TIME-OUT-FAULT state in order to prevent charging a damaged cell. See the *Charge Safety Timers* section for more information.

### FAST-CHARGE State

In the FAST-CHARGE state, the charger operates in constant-current (CC) mode and regulates the charge current to the current set by  $R_{ISET}$ . Charging continues in CC mode until  $V_{BAT}$  reaches the charge termination voltage ( $V_{TERM}$ ), at which point the state-machine jumps to the TOP-OFF state. If  $V_{BAT}$  does not reach  $V_{TERM}$  before the total time out period expires then the state-machine will jump to the “EOC” state and will re-initiate a new charge cycle after 32ms “relax”. See the *Current Limits* and *Charge Current Programming* sections for more information about setting the maximum charge current.

### TOP-OFF State

In the TOP-OFF state, the cell charges in constant-voltage (CV) mode. In CV mode operation, the charger regulates its output voltage to the 4.20V charge termination voltage, and the charge current is naturally reduced as the cell approaches full charge. Charging continues until the charge current drops to END-OF-CHARGE current threshold, at which point the state machine jumps to the END-OF-CHARGE (EOC) state.

If the state-machine does not jump out of the TOP-OFF state before the Total-Charge Time-out period expires, the state machine jumps to the EOC state and will re-initiate a new charge cycle if  $V_{BAT}$  falls below termination voltage 205mV (typ). For more information about the charge safety timers, see the *Charging Safety Times* section.

### END-OF-CHARGE (EOC) State

In the END-OF-CHARGE (EOC) state, the charger presents a high-impedance to the battery,

minimizing battery current drain and allowing the cell to “relax”. The charger continues to monitor the cell voltage, and re-initiates a charging sequence if the cell voltage drops to 205mV (typ) below the charge termination voltage.

### SUSPEND State

The state-machine jumps to the SUSPEND state any time the battery is removed, and any time the input voltage either falls below the CHGIN UVLO threshold or exceeds the OVP threshold. Once none of these conditions are present, a new charge cycle initiates.

A charging cycle may also be suspended manually by setting the SUSPEND[ ] bit. In this case, initiate a new charging sequence by clearing SUSPEND[ ] to 0.

## State Machine Interrupts

The charger features the ability to generate interrupts when the charger state machine transitions, based upon the status of the CHG\_ bits. Set CHGEOCIN[ ] bit to 1 and CHGSTAT[ ] bit to 1 to generate an interrupt when the charger state machine goes into the END-OF-CHARGE (EOC) state. Set CHGEOCOUT[ ] bit to 1 and CHGSTAT[ ] bit to 1 to generate an interrupt when the charger state machine exits the EOC state.

CHGDAT[ ] indicates the status of the charger state machine. A value of 1 indicates that the charger state machine is in END-OF-CHARGE state, a value of 0 indicates the charger state machine is in other states.

When an interrupt is generated by the charger state machine, reading the CHGSTAT[ ] returns a value of 1. CHGSTAT[ ] is automatically cleared to 0 upon reading. When no interrupt is generated by the charger state machine, reading the CHGSTAT[ ] returns a value of 0.

For additional information about the charge cycle, CSTATE[0:1] may be read at any time via  $I^2C$  to determine the current charging state.

**Table 11:**  
**Charging Status Indication**

CSTATE[0]	CSTATE[1]	STATE MACHINE STATUS
1	1	PRECONDITION State
1	0	FAST-CHARGE/ TOP-OFF State
0	1	END-OF-CHARGE State
0	0	SUSPEND/DISABLED/ FAULT State



## Thermal Regulation

The charger features an internal thermal regulation loop that monitors die temperature and reduces charging current as needed to ensure that the die temperature does not exceed the thermal regulation threshold of 110°C. This feature protects against excessive junction temperature and makes the device more accommodating to aggressive thermal designs. Note, however, that attention to good thermal designs is required to achieve the fastest possible charge time by maximizing charge current.

## Charge Safety Timers

The charger features programmable charge safety timers which help ensure a safe charge by detecting potentially damaged cells. These timers are programmable via the PRETIMO[1:0] and TOTTIMO[1:0] bits, as shown in Table 12 and Table 13. Note that in order to account for reduced charge current resulting from DCCC operation in thermal regulation mode, the charge time-out periods are extended proportionally to the reduction in charge current. As a result, the actual safety period may exceed the nominal timer period.

## Charger Timer Interrupts

The charger features the ability to generate interrupts based upon the status of the charge timers. Set the TIMRPRE[ ] bit to 1 and TIMRSTAT[ ] bit to 1 to generate an interrupt when the Precondition Timer expires. Set the TIMRTOT[ ] bit to 1 and TIMRSTAT[ ] bit to 1 to generate an interrupt when the Total-Charge Timer expires.

TIMRSTAT[ ] indicates the status of the charge timers. A value of 1 indicates a precondition time-out or a total charge time-out occurs, a value of 0 indicates other cases.

When an interrupt is generated by the charge timers, reading the TIMRSTAT[ ] returns a value of 1. TIMRSTAT[ ] is automatically cleared to 0 upon reading. When no interrupt is generated by the charge timers, reading the TIMRSTAT[ ] returns a value of 0.

**Table 12:**  
**PRECONDITION Safety Timer Setting**

PRETIMO[1]	PRETIMO[0]	PRECONDITION TIME-OUT PERIOD
0	0	40 mins
0	1	60 mins
1	0	80 mins
1	1	Disabled

**Table 13:**

**Total Safety Timer Setting**

TOTTIMO[1]	TOTTIMO[0]	TOTAL TIME-OUT PERIOD
0	0	3 hrs
0	1	4 hrs
1	0	5 hrs
1	1	Disabled

## Charge Status Indicator

The charger provides a charge-status indicator output, nSTAT. nSTAT is an open-drain output which sinks current when the charger is in an active-charging state, and is high-Z otherwise. nSTAT features an internal 8mA current limit, and is capable of directly driving a LED without the need of a current-limiting resistor or other external circuitry. To drive an LED, simply connect the LED between nSTAT pin and an appropriate supply, such as VSYS. For a logic-level charge status indication, simply connect a resistor from nSTAT to an appropriate voltage supply.

**Table 14:**  
**Charging Status Indication**

STATE	nSTAT
PRECONDITION	Active
FAST-CHARGE	Active
TOP-OFF	Active
END-OF-CHARGE	High-Z
SUSPEND	High-Z
TEMPERATURE FAULT	High-Z
TIME-OUT-FAULT	High-Z

## Reverse-Current Protection

The charger includes internal reverse-current protection circuitry that eliminates the need for blocking diodes, reducing solution size and cost as well as dropout voltage relative to conventional battery chargers. When the voltage at CHGIN falls below V<sub>BAT</sub>, the charger automatically reconfigures its power switch to minimize current drawn from the battery.

## Battery Temperature Monitoring

In a typical application, the TH pin is connected to the battery pack's thermistor input, as shown in Figure 7. The charger continuously monitors the temperature of the battery pack by injecting a 102µA (typ) current into the thermistor (via the TH

pin) and sensing the voltage at TH. The voltage at TH is continuously monitored, and charging is suspended if the voltage at TH exceeds either of the internal  $V_{THH}$  and  $V_{THL}$  thresholds of 0.5V and 2.51V, respectively.

The net resistance (from TH to GA) required to cross the thresholds are given by:

$$102\mu\text{A} \times R_{\text{NOM}} \times k_{\text{HOT}} = 0.5\text{V} \rightarrow R_{\text{NOM}} \times k_{\text{HOT}} \approx 5\text{k}\Omega$$

$$102\mu\text{A} \times R_{\text{NOM}} \times k_{\text{COLD}} = 2.51\text{V} \rightarrow R_{\text{NOM}} \times k_{\text{COLD}} \approx 25\text{k}\Omega$$

where  $R_{\text{NOM}}$  is the nominal thermistor resistance at room temperature, and  $k_{\text{HOT}}$  and  $k_{\text{COLD}}$  represent the ratios of the thermistor's resistance at the desired hot and cold thresholds, respectively, to the resistance at 25°C.

### Battery Temperature Interrupts

In order to ease detecting the status of the battery temperature, the charger features the ability to generate interrupts based upon the status of the battery temperature. Set the  $\text{TEMPOUT}[\ ]$  bit to 1 and  $\text{TEMPSTAT}[\ ]$  bit to 1 to generate an interrupt when battery temperature goes out of the valid temperature range. Set the  $\text{TEMPIN}[\ ]$  bit to 1 and  $\text{TEMPSTAT}[\ ]$  bit to 1 to generate an interrupt when battery temperature returns to the valid range.

$\text{TEMPDAT}[\ ]$  indicates the status of the battery temperature. A value of 1 indicates the battery temperature is inside of the valid range, a value of 0 indicates the battery is outside of the valid range.

When an interrupt is generated by the battery temperature event, reading the  $\text{TEMPSTAT}[\ ]$  returns a value of 1.  $\text{TEMPSTAT}[\ ]$  is automatically cleared to 0 upon reading. When no interrupt is generated by the battery temperature event, reading the  $\text{TEMPSTAT}[\ ]$  returns a value of 0.

**Figure 7:**  
**Simple Configuration**

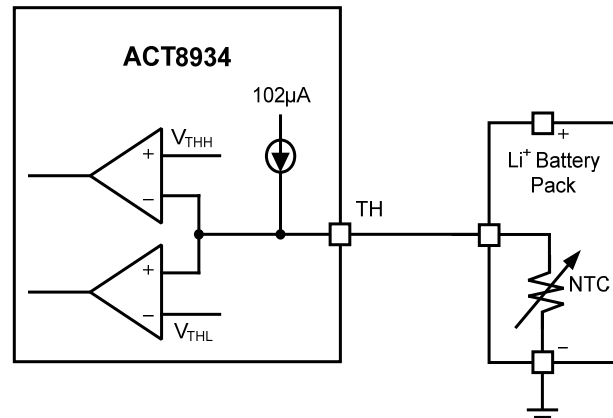

## TQFN55-40 PACKAGE OUTLINE AND DIMENSIONS

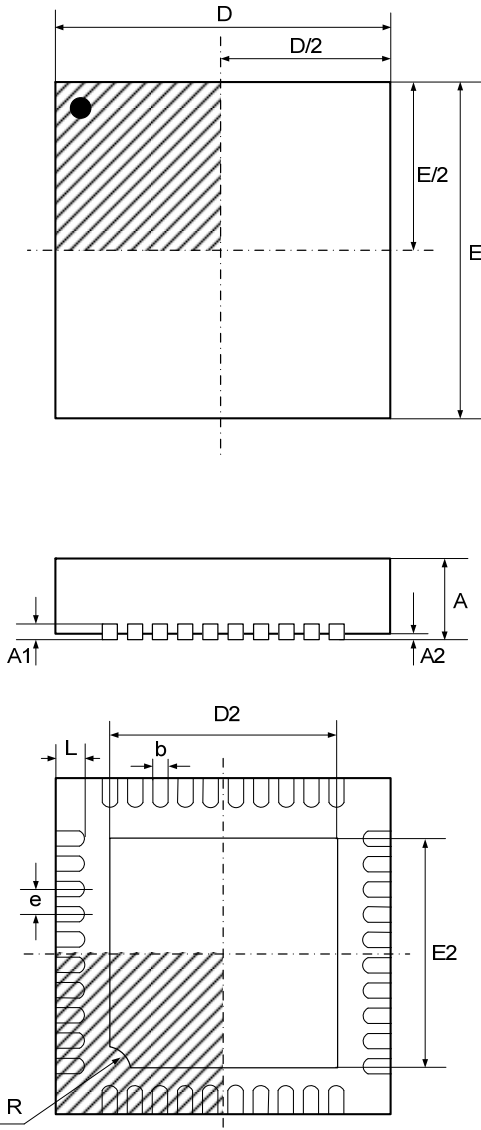

SYMBOL	DIMENSION IN MILLIMETERS		DIMENSION IN INCHES	
	MIN	MAX	MIN	MAX
A	0.700	0.800	0.028	0.031
A1	0.200 REF		0.008 REF	
A2	0.000	0.050	0.000	0.002
b	0.150	0.250	0.006	0.010
D	4.900	5.100	0.193	0.201
E	4.900	5.100	0.193	0.201
D2	3.450	3.750	0.136	0.148
E2	3.450	3.750	0.136	0.148
e	0.400 BSC		0.016 BSC	
L	0.300	0.500	0.012	0.020
R	0.300		0.012	

Active-Semi, Inc. reserves the right to modify the circuitry or specifications without notice. Users should evaluate each product to make sure that it is suitable for their applications. Active-Semi products are not intended or authorized for use as critical components in life-support devices or systems. Active-Semi, Inc. does not assume any liability arising out of the use of any product or circuit described in this datasheet, nor does it convey any patent license.

Active-Semi and its logo are trademarks of Active-Semi, Inc. For more information on this and other products, contact [sales@active-semi.com](mailto:sales@active-semi.com) or visit <http://www.active-semi.com>.

 is a registered trademark of Active-Semi.