

# Surface Mount Multiband Chip Antenna 490 / 783 / 868 & 915MHz



16.0 x 3.0 x 1.4mm

**ACA-105-T**



RoHS / RoHS II Compliant



Moisture Sensitivity Level (MSL) – MSL = 1

## FEATURES:

- Wide band ISM Chip Antenna covering 4 bands from 490MHz to 915MHz
- Matching via lumped elements with single footprint
- Constructed from solid dielectric ceramic material
- Suitable for RoHS compliant reflow
- Peak Gain -2.73 ~ 3.28dBi (dependant on band)
- Average Gain -6.27 ~ -1.10dBi (dependant on band)
- VSWR 3.0 : 1 max
- Size – 16.0 x 3.0 x 1.4mm (0.63 x 0.11 x 0.055 inch)
- Non Ground Mounting type
- Linear Polarization
- Matched to 50 Ohm.

## APPLICATIONS:

- 470 ~ 510MHz
  - Mobile ISM band radios
  - Chinese Automatic Meter Reading (AMR)
  - Smart Metering & Smart Grid
  - LMRS 470–490 MHz, and 490–512 MHz in urban areas
  - Ultra Low Power Applications.
- 779 ~ 787 MHz
  - IEEE 802.15.4c Wireless PAN use within China.
  - Short range devices
- 858 ~ 878MHz
  - IEEE 802.15.4 (868 - 868.6MHz) Europe
  - SDR European Standards by ETSI (863 ~ 870MHz).
- 902 ~ 928MHz
  - IEEE 802.15.4 (902 ~ 928MHz) Band 2 ISM US & Americas
  - FCC Part 15.247: 902-928 MHz

## STANDARD SPECIFICATIONS

### Maximum Ratings

Item	Value
ESD Voltage	15kV [HBM Class 3B]
Operating Temperature Range	-40°C to + 85°C
Storage Temperature Range	-40°C to + 85°C

### 3D Electrical Characteristics for 470 ~ 510MHz

ITEM		SPECIFICATION		
Frequency Range		490 ±20MHz		
VSWR		3: 1 Max		
Polarization		Linear		
Frequency [MHz]		470	490	510
Gain [dBi]	Peak	-3.52	-2.73	-4.02
	Average	-7.17	-6.27	-7.42
Efficiency [%]		19.08	23.47	18.00

### 2D Electrical Characteristics for 470 ~ 510MHz

2D MEASUREMENT				
Gain [dBi]	Azimuth	Theta	Peak	-5.46
			Average	-6.00
		Phi	Peak	-12.10
			Average	-14.54
	Elevation 1	Theta	Peak	-10.78
			Average	-14.82
		Phi	Peak	-4.42
			Average	-7.72
	Elevation 2	Theta	Peak	-10.34
			Average	-15.10
		Phi	Peak	-4.39
			Average	-8.90



# Surface Mount Multiband Chip Antenna 490 / 783 / 868 & 915MHz



16.0 x 3.0 x 1.4mm

**ACA-105-T**



RoHS / RoHS II Compliant



## 3D Electrical Characteristics for 779 ~ 787MHz

ITEM		SPECIFICATION		
Frequency Range		783 ±4MHz		
VSWR		2: 1 Max		
Polarization		Linear		
Frequency [MHz]		779	783	787
Gain [dBi]	Peak	-2.86	3.01	2.65
	Average	-1.05	-0.95	-1.30
Efficiency [%]		78.72	80.37	74.25

## 2D Electrical Characteristics for 779 ~ 787MHz

2D MEASUREMENT				
Gain [dBi]	Azimuth	Theta	Peak	2.58
			Average	1.30
		Phi	Peak	-4.56
			Average	-9.04
	Elevation 1	Theta	Peak	-1.80
			Average	-6.80
		Phi	Peak	2.42
			Average	-2.68
	Elevation 2	Theta	Peak	-7.50
			Average	-11.69
		Phi	Peak	2.49
			Average	-2.84

## 3D Electrical Characteristics for 858 ~ 878MHz

ITEM		SPECIFICATION		
Frequency Range		868 ±10MHz		
VSWR		2: 1 Max		
Polarization		Linear		
Frequency [MHz]		858	868	878
Gain [dBi]	Peak	2.41	2.98	2.72
	Average	-1.15	-0.79	-1.23
Efficiency [%]		76.93	83.57	75.53

## 2D Electrical Characteristics for 858 ~ 878MHz

2D MEASUREMENT				
Gain [dBi]	Azimuth	Theta	Peak	2.24
			Average	1.34
		Phi	Peak	-12.18
			Average	-15.31
	Elevation 1	Theta	Peak	-7.73
			Average	-11.91
		Phi	Peak	3.37
			Average	-1.62
	Elevation 2	Theta	Peak	-12.41
			Average	-17.81
		Phi	Peak	3.08
			Average	-1.60



# Surface Mount Multiband Chip Antenna 490 / 783 / 868 & 915MHz



16.0 x 3.0 x 1.4mm

## ACA-105-T



RoHS / RoHS II Compliant



### 3D Electrical Characteristics for 902 ~ 928MHz

ITEM		SPECIFICATION		
Frequency Range		915 ±13MHz		
VSWR		2: 1 Max		
Polarization		Linear		
Frequency [MHz]		902	915	928
Gain [dBi]	Peak	3.25	3.28	2.46
	Average	-1.20	-1.10	-1.86
Efficiency [%]		76.03	77.80	65.22

### 2D Electrical Characteristics for 902 ~ 928MHz

2D MEASUREMENT				
Gain [dBi]	Azimuth	Theta	Peak	0.73
			Average	0.04
		Phi	Peak	-13.48
			Average	-15.83
	Elevation 1	Theta	Peak	-11.40
			Average	-15.59
		Phi	Peak	2.79
			Average	-2.13
	Elevation 2	Theta	Peak	-10.45
			Average	-15.53
		Phi	Peak	3.09
			Average	-1.89

### PART IDENTIFICATION:

ACA-105-

**Packaging**

Blank: Bulk

T: Tape and Reel

# Surface Mount Multiband Chip Antenna 490 / 783 / 868 & 915MHz



16.0 x 3.0 x 1.4mm

**ACA-105-T**



RoHS / RoHS II Compliant



## OUTLINE DIMENSIONS:

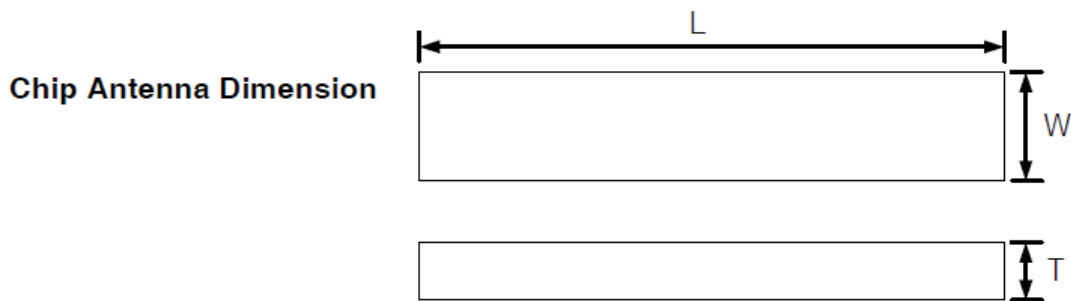

### Recommended Land Pattern

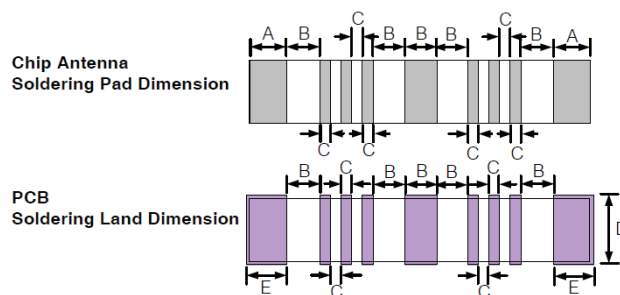

	Condition
Pre-Heating Temperature	120 °C , 60 ~ 300 sec
Soldering Temperature	340°C ± 5°C , 5 sec max per each terminal

(Dimensions: mm)

## REFLOW PROFILE:

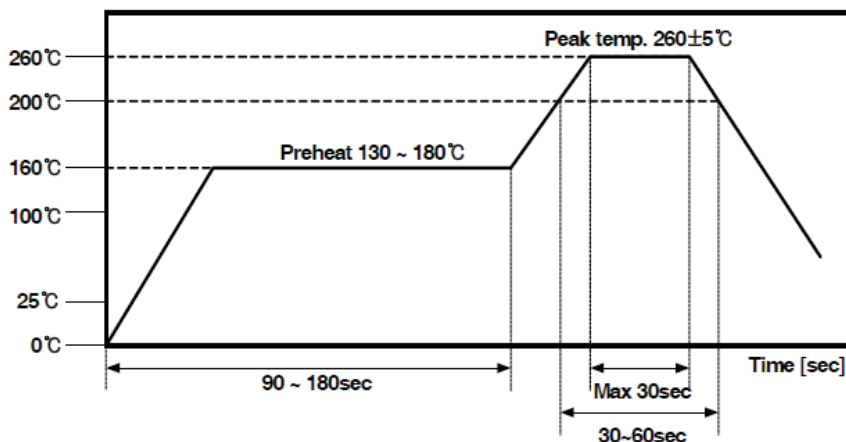

### Manual Soldering

Parameter	L	W	T	A	B	C	D	E
Value (mm)	16.0	3.0	1.4	1.75	1.5	0.5	3.3	1.9
Tol: ± 0.1mm								

# Surface Mount Multiband Chip Antenna 490 / 783 / 868 & 915MHz



16.0 x 3.0 x 1.4mm

**ACA-105-T**



RoHS / RoHS II Compliant



## TAPE & REEL:

**Packaging: 5,000 Units Per Reel**

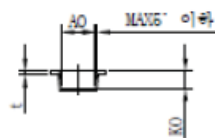
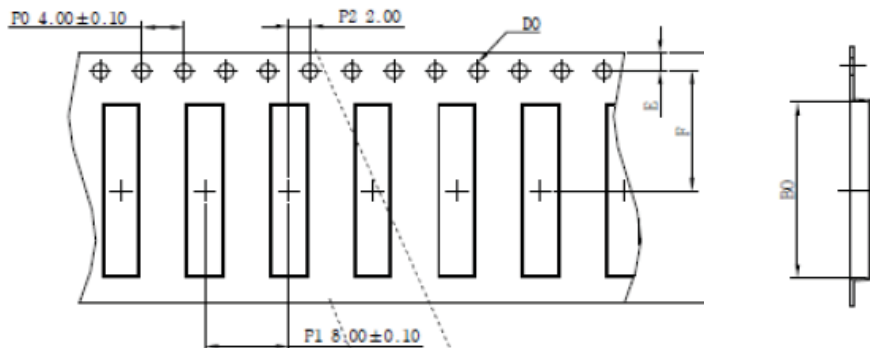

Taping style

### INPUT MARKING

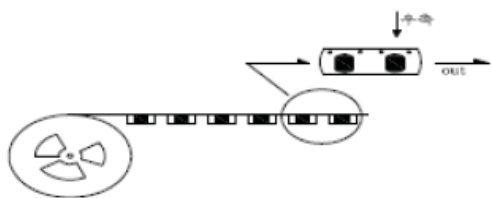
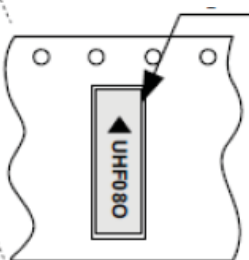

A0	3.3±0.10mm	E	1.75±0.10mm
B0	16.3±0.10mm	F	11.50mm
K0	1.6±0.10mm	t	0.3±0.05mm
D0	1.55±0.50mm	w	24.00±0.30mm

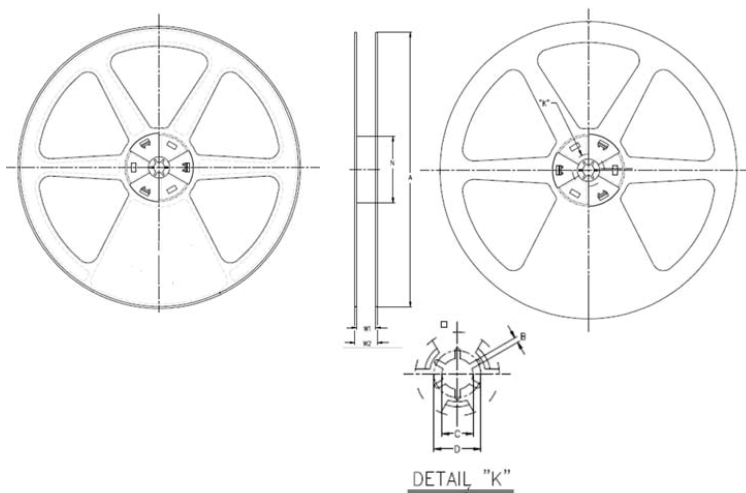

Size	24mm Reel
A	330 +0.2 / -2.0mm
B	2.0 +0.5 / -0.2mm
C	13.0 +0.5 / -0.0mm
D	20.2mm Min
N	80 +3.0 / -0.0mm
W1	24.4 +3.0 / -0.0mm
W2	28.4 +2.0 / -2.0mm

(Dimensions: mm)

**ATTENTION:** Abracon Corporation's products are COTS – Commercial-Off-The-Shelf products; suitable for Commercial, Industrial and, where designated, Automotive Applications. Abracon's products are not specifically designed for Military, Aviation, Aerospace, Life-dependant Medical applications or any application requiring high reliability where component failure could result in loss of life and/or property. For applications requiring high reliability and/or presenting an extreme operating environment, written consent and authorization from Abracon Corporation is required. Please contact Abracon Corporation for more information.

ABRACON IS  
ISO9001:2008  
CERTIFIED



**ABRACON**  
CORPORATION

Visit [www.abracon.com](http://www.abracon.com) for Terms & Conditions of Sale **Revised: 10.06.14**

30332 Esperanza, Rancho Santa Margarita, California 92688

tel 949-546-8000 | fax 949-546-8001 | [www.abracon.com](http://www.abracon.com)